

NPDES compliance summary report,
fiscal year 1999

Massachusetts Water Resources Authority

Environmental Quality Department
Report ENQUAD 00-07



NPDES COMPLIANCE SUMMARY REPORT
Fiscal Year 1999

Douglas B. MacDonald
Executive Director

Richard P. Trubiano
Deputy Director

Dr. Andrea C. Rex, Director
Environmental Quality Department

By
Jennifer Daquioag
Patrick Terrien

Technical Report No. 00-07
NPDES Compliance Unit
Environmental Quality Department
Sewerage Division
Massachusetts Water Resources Authority
100 First Avenue
Charlestown Navy Yard
Boston, MA 02129
(617) 242-6000

Acknowledgements

This report was written by Jennifer Daquioag and Patrick Terrien under the direction of Grace Bigornia-Vitale, Sr. Program Manager. Kelly Coughlin assisted in downloading and analyzing data. Mark Sullivan, Kelly Coughlin, Maury Hall and Craig Schissler all contributed to and/or reviewed this report. The work done by Esther Graf, Jennifer Sullivan, Erin Graham and Alex Pancic for previous years' reports is incorporated in this report.

Citation:

Daquioag J, Terrien P. 2000. NPDES compliance summary report, fiscal year 1999. Boston: Massachusetts Water Resources Authority. Report ENQUAD 00-07. 235 p.

Table of Contents

LIST OF TABLES

LIST OF FIGURES

EXECUTIVE SUMMARY	ES-1
DEER ISLAND TREATMENT PLANT	ES-1
COMBINED SEWER OVERFLOW FACILITIES	ES-7
SYSTEM CAPACITY	ES-9
FUTURE OUTLOOK	ES-11
I INTRODUCTION	I-1
II DEER ISLAND TREATMENT PLANT.....	II-1
II.A MONITORING RESULTS	
II.A.1 Influent Characteristics	II-1
II.A.1.a Flow	II-1
II.A.1.b Conventional Parameters and Nutrients.....	II-3
II.A.1.c Priority Pollutants	II-7
II.A.2 Effluent Characteristics	II-10
II.A.2.a Conventional Parameters	II-10
II.A.2.b Nutrients	II-14
II.A.2.c Priority Pollutants	II-14
II.A.2.d Whole Effluent Toxicity.....	II-16
II.A.2.e Bioaccumulation Study	II-17
II.B DISCUSSION	
II.B.1 Compliance with Regulatory Limits	II-23
II.B.2 Effluent Quality Compared to Water Quality Standards.....	II-29
III COMBINED SEWER OVERFLOW FACILITIES	III-1
III.A COTTAGE FARM COMBINED SEWER OVERFLOW FACILITY	
III.A.1 Activations.....	III-1
III.A.2 Conventional Parameters	III-4
III.A.3 Priority Pollutants.....	III-5
III.B PRISON POINT COMBINED SEWER OVERFLOW FACILITY	
III.B.1 Activations	III-6
III.B.2 Conventional Parameters	III-8
III.B.3 Priority Pollutants.....	III-9
III.C SOMERVILLE MARGINAL COMBINED SEWER OVERFLOW FACILITY	
III.C.1 Activations	III-10
III.C.2 Conventional Parameters	III-13

III.C.3 Priority Pollutants	III-13
III.D CONSTITUTION BEACH COMBINED SEWER OVERFLOW FACILITY	
III.D.1 Activations	III-14
III.D.2 Conventional Parameters	III-17
III.E FOX POINT COMBINED SEWER OVERFLOW FACILITY	
III.E.1 Activations	III-18
III.E.2 Conventional Parameters	III-21
III.F COMMERCIAL POINT COMBINED SEWER OVERFLOW FACILITY	
III.F.1 Activations.....	III-21
III.F.2 Conventional Parameters.....	III-24
IV TRANSPORT SYSTEMS	IV-1
IV.A NORTH SYSTEM	
IV.A.1 Headworks Choking.....	IV-1
IV.A.2 Sanitary Sewer Overflows	IV-3
IV.B SOUTH SYSTEM	
IV.B.1 Sanitary Sewer Overflows	IV-4
APPENDICES	
APPENDIX A.....DEER ISLAND TREATMENT PLANT DATA TABLES	
APPENDIX B..... COTTAGE FARM CSO FACILITY DATA TABLES	
APPENDIX C..... PRISON POINT CSO FACILITY DATA TABLES	
APPENDIX D.....SOMERVILLE MARGINAL CSO FACILITY DATA TABLES	
APPENDIX E..... CONSTITUTION BEACH CSO FACILITY DATA TABLES	
APPENDIX F.....FOX POINT CSO FACILITY DATA TABLES	
APPENDIX G.....COMMERCIAL POINT CSO FACILITY DATA TABLES	
APPENDIX H.....NPDES MONITORING REQUIREMENTS	
H.1 PERMITS AND COMPLIANCE ORDER.....	H-2
H.1.a NPDES Permit	H-2
H.1.b Court Order	H-2
H.2 MONITORING PROGRAMS	H-8
H.2.a Treatment Plant Monitoring Program	H-8
H.2.b Combined Sewer Overflow Facilities Monitoring Program.....	H-9
H.2.c Sewer System Monitoring Program	H-9
H.3 TREATMENT OF RESULTS	H-10

APPENDIX I.....AN OVERVIEW OF MWRA SEWERAGE SYSTEM AND FACILITIES

I.1 NORTH SYSTEMI-4
 I.1.a Pump Stations.....I-6
 I.1.b HeadworksI-7
 I.1.c Combined Sewer Overflow Facilities.....I-7
I.2 SOUTH SYSTEM.....I-13
 I.2.a Pump Stations.....I-13
 I.2.b HeadworksI-14
I.3 DEER ISLAND TREATMENT PLANT.....I-16
 I.3.a Deer Island Outfalls.....I-18
 I.3.b Nut Island Outfalls.....I-19
 I.3.c Outfall Tunnel.....I-21
I.4 SANITARY SYSTEM OVERFLOWSI-22

APPENDIX J.....INSTRUMENT DETECTION LIMITS, METHOD DETECTION LIMITS, AND QUANTITATION LIMITS: A BRIEF DESCRIPTION

APPENDIX K PRIORITY POLLUTANTS AND OTHER PARAMETERS

APPENDIX L GLOSSARY, ABBREVIATIONS/ACRONYMS, AND UNITS

List of Tables

Table 1	Sanitary Sewer Overflows, FY99	ES-10
Table II.A.1	Classification of Deer Island Influent, FY99	II-4
Table II.A.2	Deer Island Influent Characterization, FY93-FY99.....	II-5
Table II.A.3	Deer Island Removal Efficiency, FY99	II-10
Table II.A.4	Removal Efficiencies vs. Degree of Secondary Treatment, FY99	II-11
Table II.A.5	Deer Island Effluent Characterization, FY93-FY99	II-12
Table II.A.6	Deer Island Effluent, Results of Toxicity Testing, FY99	II-17
Table II.A.7	Concentrations of Metals Bioaccumulating in Boston Harbor Mussels	II-20
Table II.A.8	Concentrations of Contaminants Bioaccumulating in Boston Harbor Mussels..	II-21
Table II.B.1	Deer Island Effluent Quality Compared to Interim Limits	II-23
Table II.B.2	NPDES Violations at Deer Island, FY94-FY99	II-24
Table II.B.3	Comparison of Deer Island Treatment Plant Effluent with Water Quality Criteria, FY99	II-29
Table III.A.1	Cottage Farm CSO Activations Summary	III-2
Table III.A.2	Cottage Farm CSO Influent and Effluent Characteristics, FY99.....	III-5
Table III.A.3	Cottage Farm Metals, FY99.....	III-5
Table III.B.1	Prison Point CSO Activations Summary	III-6
Table III.B.2	Prison Point CSO Influent and Effluent Characteristics, FY99.....	III-9
Table III.B.3	Prison Point Metals, FY99	III-9
Table III.C.1	Somerville Marginal CSO Activations Summary.....	III-10
Table III.C.2	Somerville Marginal CSO Influent and Effluent Characteristics, FY99	III-13
Table III.C.3	Somerville Marginal Metals, FY99	III-14
Table III.D.1	Constitution Beach CSO Activations Summary	III-15
Table III.D.2	Constitution Beach CSO Influent and Effluent Characteristics, FY99.....	III-18
Table III.E.1	Fox Point CSO Activations Summary	III-19
Table III.E.2	Fox Point CSO Influent and Effluent Characteristics, FY99.....	III-21
Table III.F.1	Commercial Point CSO Activations Summary.....	III-22
Table III.F.2	Commercial Point CSO Influent and Effluent Characteristics, FY99	III-24
Table IV.A.1	Sanitary Sewer Overflows, North System, FY98 and FY99	IV-4
Table IV.B.1	Sanitary Sewer Overflows, South System, FY98 and FY99	IV-4

List of Figures

Figure 1	Deer Island Flows	ES-2
Figure 2	Deer Island Dry Day Flows	ES-3
Figure 3	Deer Island TSS Removal Rates.....	ES-4
Figure 4	Deer Island BOD Removal Rates	ES-4
Figure 5	NPDES Violations at Deer Island.....	ES-6
Figure 6	CSO Facility Activations, FY92-FY99.....	ES-8
Figure 7	CSO Volume Treated, FY92-FY99	ES-8
Figure 8	Choking, FY92-FY99	ES-9
Figure II.A.1	Deer Island Flows Compared to Precipitation, FY99	II-2
Figure II.A.2	Deer Island Average Flow Compared to Precipitation, FY88-FY99.....	II-2
Figure II.A.3	Frequency Distribution of Deer Island Flow, FY99	II-3
Figure II.A.4	Deer Island Average Influent Metals Loadings, FY92-FY99.....	II-7
Figure II.A.5	Deer Island Average Influent Organics Loadings, FY94-FY99	II-9
Figure II.A.6	Deer Island Effluent Nutrient Concentrations, FY93-FY99	II-14
Figure II.A.7	Deer Island Average Effluent Metals Loadings, FY89-FY99	II-15
Figure II.A.8	Deer Island Average Effluent Organics Loadings, FY94-FY99.....	II-15
Figure II.B.1	Deer Island Treatment Plant Effluent BOD Trend Analysis, FY99	II-25
Figure II.B.2	Deer Island Treatment Plant Effluent TSS Trend Analysis, FY99	II-25
Figure II.B.3	Deer Island Treatment Plant Effluent Fecal Coliform Trend Analysis, FY99.....	II-26
Figure II.B.4	Deer Island Treatment Plant Effluent Total Coliform Trend Analysis, FY99.....	II-27
Figure II.B.5	Deer Island Treatment Plant Effluent pH Trend Analysis, FY99	II-28
Figure II.B.6	Deer Island Treatment Plant Effluent Settleable Solids Trend Analysis, FY99	II-28
Figure III.A.1	Cottage Farm CSO Activations, FY92-FY99	III-2
Figure III.A.2	Cottage Farm Total Volume Treated Compared to Precipitation, FY92-FY99.....	III-3
Figure III.A.3	Frequency Distribution of Rainfall, Cottage Farm, FY99	III-4
Figure III.B.1	Prison Point CSO Activations, FY92-FY99	III-7
Figure III.B.2	Prison Point Total Volume Treated Compared to Precipitation, FY92-FY99.....	III-7
Figure III.B.3	Frequency Distribution of Rainfall, Prison Point, FY99	III-8
Figure III.C.1	Somerville Marginal CSO Activations, FY92-FY99.....	III-11
Figure III.C.2	Somerville Marginal Total Volume Treated Compared to Precipitation, FY92-FY99	III-12
Figure III.C.3	Frequency Distribution of Rainfall, Somerville Marginal, FY99	III-12
Figure III.D.1	Constitution Beach CSO Activations, FY92-FY99	III-15
Figure III.D.2	Constitution Beach Total Volume Treated Compared to Precipitation, FY92-99	III-16
Figure III.D.3	Frequency Distribution of Rainfall, Constitution Beach, FY99	III-17
Figure III.E.1	Fox Point CSO Activations, FY92-FY99	III-19
Figure III.E.2	Fox Point Total Volume Treated Compared to Precipitation, FY92-FY99.....	III-20
Figure III.E.3	Frequency Distribution of Rainfall, Fox Point, FY99	III-20
Figure III.F.1	Commercial Point CSO Activations, FY92-FY99.....	III-22
Figure III.F.2	Commercial Point Total Volume Treated Compared to Precipitation, FY92-FY99	III-23
Figure III.F.3	Frequency Distribution of Rainfall, Commercial Point, FY99	III-24

Figure IV.A.1	Choking, FY92-FY99	IV-1
Figure IV.A.2	Rain-Related Choking, FY92-FY99	IV-2
Figure IV.A.3	Testing/Maintenance Choking, FY92-FY99.....	IV-3

Executive Summary

This report presents and summarizes monitoring and compliance data collected and analyzed by the Massachusetts Water Resources Authority (MWRA) NPDES Compliance Unit from July 1998 to June 1999. The Fiscal Year Summary Report, while not a regulatory requirement, provides a useful documentation of influent and effluent quality trends over the course of a fiscal year.

Deer Island Treatment Plant

MWRA is required under its National Pollutant Discharge Elimination System (NPDES) permit to monitor its wastewater treatment plant at Deer Island for specified parameters. The permit calls for secondary treatment. Since the secondary treatment facilities at Deer Island were not completed when the permit was issued, the plant is regulated under court ordered interim limits. Secondary treatment began at Deer Island in early FY98 with the introduction of the first battery of secondary treatment (battery A). In mid-FY98, Battery B was subjected to testing and by March 1998, both batteries of treatment were in use. Full secondary treatment at Deer Island will include three batteries of treatment. Battery C is expected to come on-line in FY00.

At the start of this fiscal year, all South System flow was transferred from Nut Island to Deer Island via the inter-island tunnel. The old Nut Island Treatment Plant was decommissioned and became the site of the new Nut Island Headworks.

In May 1999, the EPA and DEP issued a new permit for Deer Island, which is under appeal by MWRA and several parties. The MWRA continues to operate under the existing permit and the interim court order limits. After the completion of secondary Battery C, the next milestone for the Boston Harbor Project is the startup of the new 9.5-mile outfall tunnel that will carry treated wastewater from Deer Island to Massachusetts Bay. The outfall tunnel is expected to open in FY00.

The new NPDES permit will allow for discharge from this tunnel.

Figure 1 shows the Deer Island flow during each month of FY99, comparing the flow with the monthly averages of the previous nine years. The FY99 data includes both North and South System flows, while the FY90-FY98 data shows the calculated combined Deer Island and Nut Island flows.

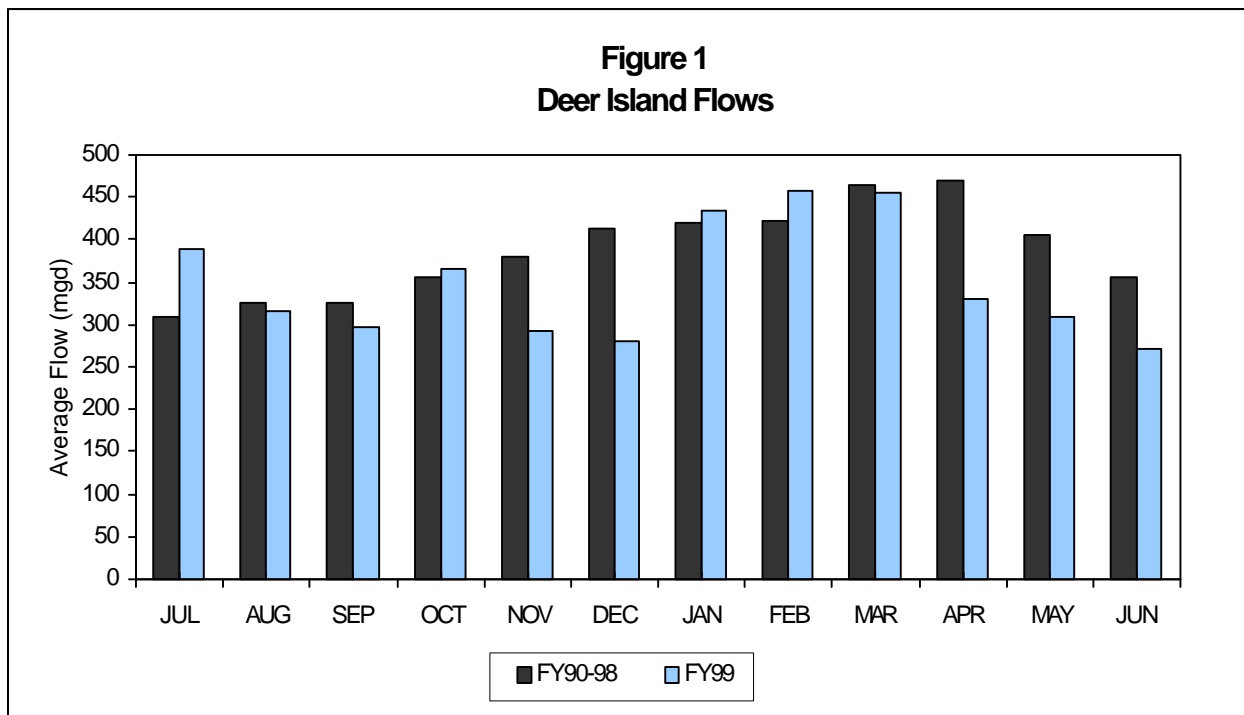
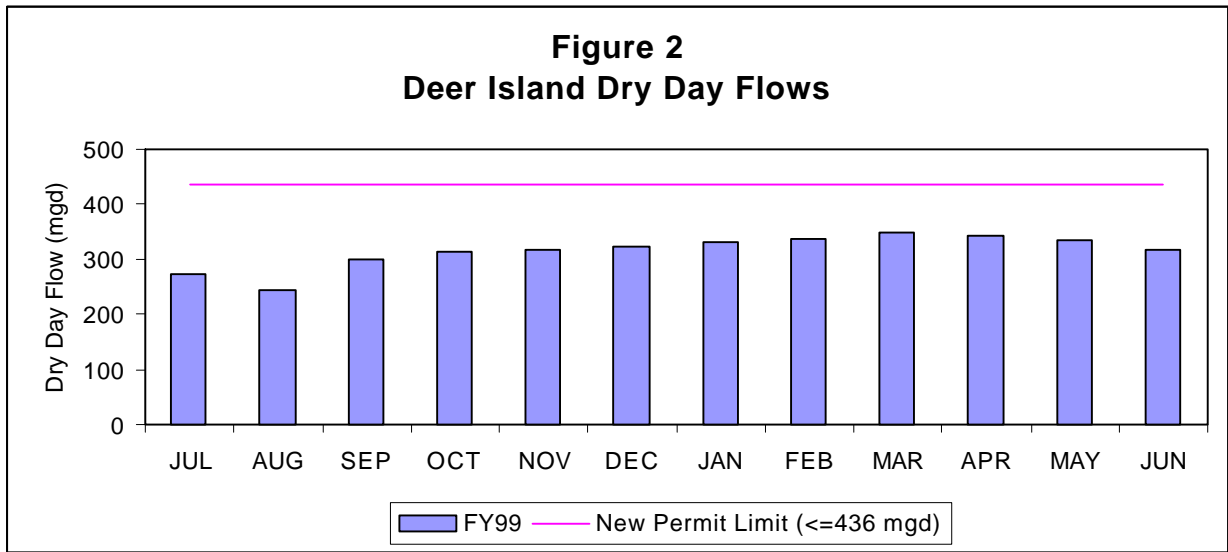

Figure 2 shows the dry day flow for Deer Island during each month of FY99. A dry day is defined as a day with 0.09 inches of precipitation or less and no snow melt, provided that the precipitation on the previous day is less than 0.3 inches, the precipitation two days prior is less than 1.0 inch, and the precipitation three days prior is less than 2.0 inches. A day with snow melt is defined as a day when there is snow on the ground and the air temperature is above 32 °F. The numbers are calculated for each month by averaging the dry day flow over the previous 365 days. The solid line represents the running average dry day flow limit of 436 mgd for the new NPDES permit. Under this permit which is not yet in effect, there were no violations of the dry day flow limit for FY99.



The results of improved treatment at the new Deer Island Treatment Plant (DITP) are becoming apparent. Since the new primary treatment plant was brought on-line in FY95, the removal rates for both TSS and BOD have improved significantly (see Figures 3 and 4). In FY96 and FY97, removal efficiencies compared favorably to theoretical removal efficiencies for primary treatment, with TSS removal above and BOD removal within the theoretical ranges. In FY98, the efficiencies continued to improve, especially for BOD, with a removal rate well above the theoretical range.¹ The introduction of secondary treatment in FY98 contributed to this improved efficiency. In FY99, the removal efficiencies for both BOD and TSS increased, even with only two batteries of secondary treatment on-line. The TSS removal rate approached 90% and the BOD rate exceeded 80%.

¹ Metcalf & Eddy, Inc. 1972. Wastewater Engineering: Collection, Treatment, Disposal. New York: McGraw-Hill Book Company. p. 446.

Figure 3
Deer Island TSS Removal Rates

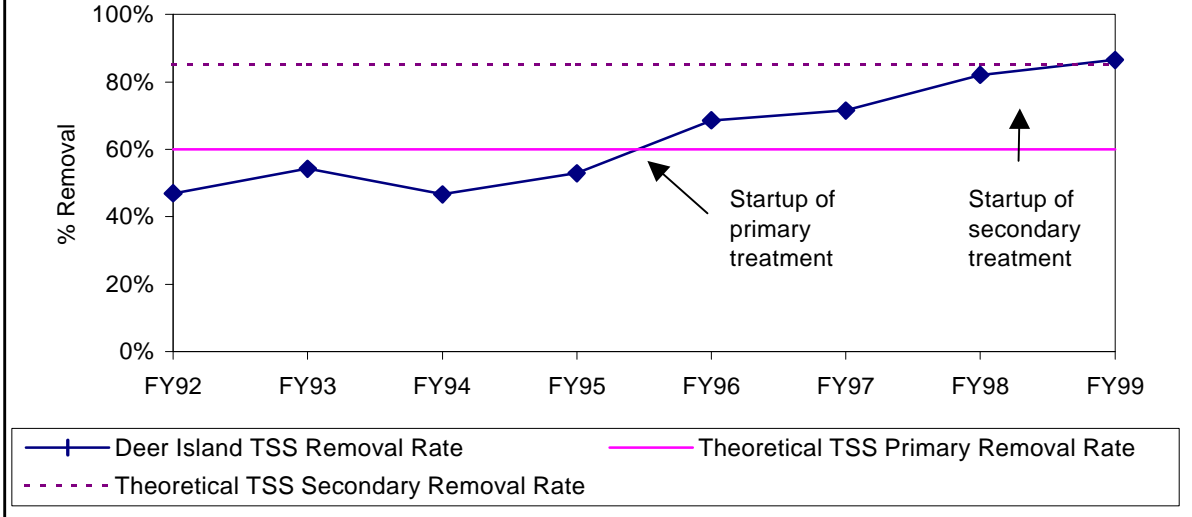
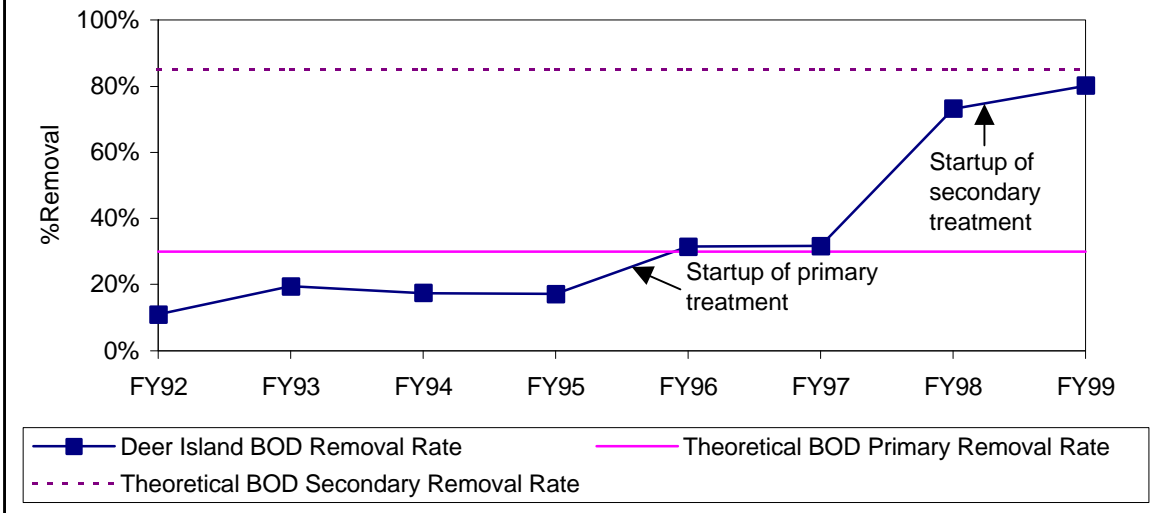

Figure 4
Deer Island BOD Removal Rates



The impact of improved treatment at DITP can also be seen in the number of annual NPDES violations, which has decreased dramatically. Figure 5 compares the number of violations of the NPDES permit at Deer Island in FY99 to previous years. There were no non-toxicity NPDES violations in FY99, one in FY98 and none in FY97, while there were 12 in FY96 and 19 in each of the previous two years. There were 13 toxicity violations this year. One involved the *Cyprinodon* chronic test and the remainder involved the *Champia* chronic test, which the EPA has withdrawn in future permits due to the questionable reliability of the species. Some of the reductions in the number of violations can be attributed to a change in testing methods for PHCs, but much of it has resulted from improved treatment.

Not included in Figure 5 are the pH violations during FY99. On 70 occasions, the pH fell below the minimum regulatory limit of 6.5. However, these violations can be qualified, since they are a direct result of approved treatment technologies. The secondary treatment system, a pure oxygen system, lowers the pH as excess carbon dioxide (a result of biomass respiration) dissolves into the effluent. The new NPDES permit will account for the expected lowered pH by expanding the pH limits to 6.0-9.0. The artificially lowered pH has no measurable impact on water quality because of the buffering capacity of the receiving waters.

**Figure 5
NPDES Violations at Deer Island**

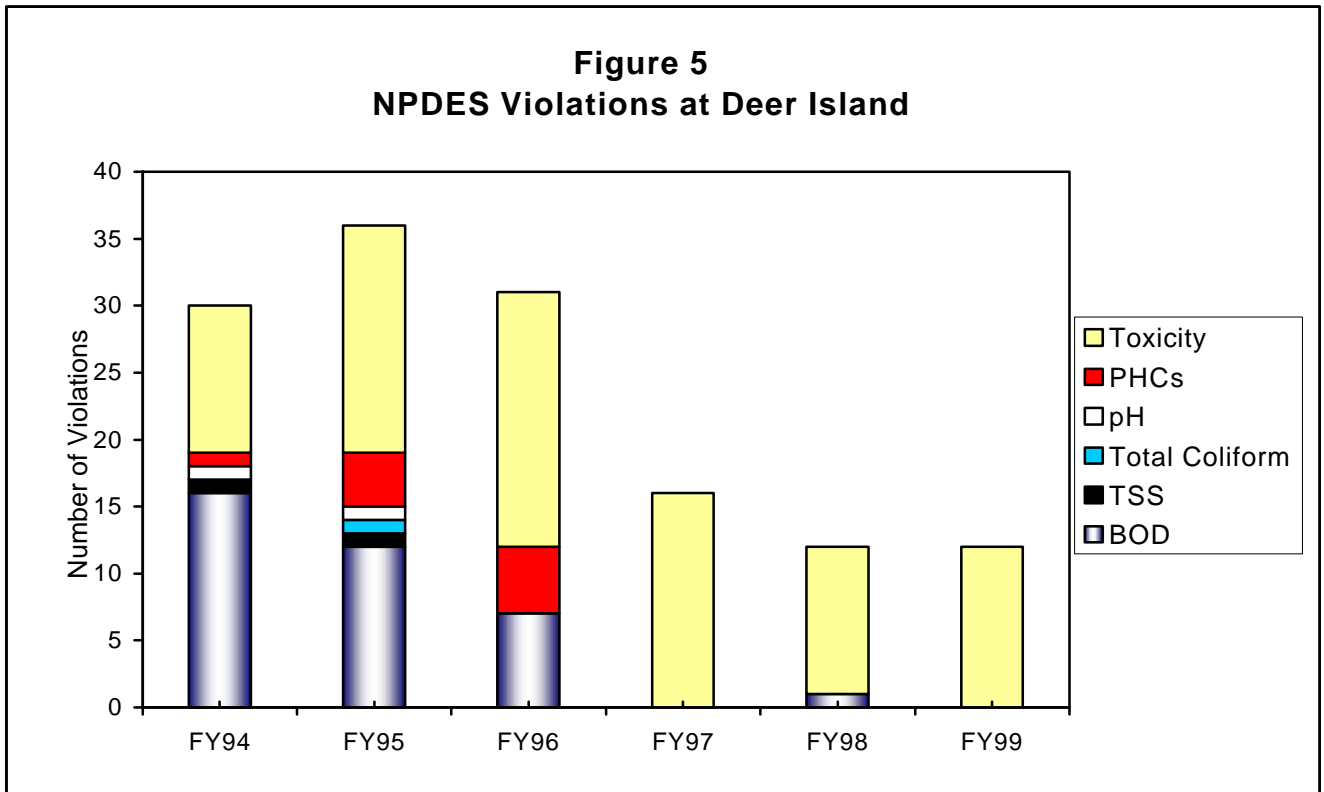

Deer Island also saw improvements in priority pollutant loadings. Decreases in influent metals loadings may be partly due to corrosion control activities and source reduction. Some of the reduction in the effluent may also be caused by better capture of metals by the new plant. Based on the available dilution in the harbor, there is no potential for the priority pollutants to exceed the water quality standards.

Combined Sewer Overflow Facilities

MWRA has three Combined Sewer Overflow (CSO) facilities – Cottage Farm, Prison Point and Somerville Marginal – which are required to be monitored under the existing NPDES permit. In addition, MWRA monitors three other CSO facilities, at Constitution Beach, Fox Point and Commercial Point, which are currently included in the Boston Water and Sewer Commission (BWSC) NPDES permit. MWRA’s new NPDES permit will require monitoring of these facilities.

Figures 6 and 7 show the number of activations as well as the total volume treated at the six CSO facilities over the past eight years. The correlation between rainfall and CSO activation can also be seen in Figures 6 and 7. Note that although total rainfall is correlated to CSO activation, the intensity of the rainfall will have an important effect, as will the frequency of the storms. These storm characteristics will influence the degree of ground saturation, which will affect the volume that is treated at the CSO facilities during a storm.

Figure 6
CSO Facility Activations, FY92-FY99

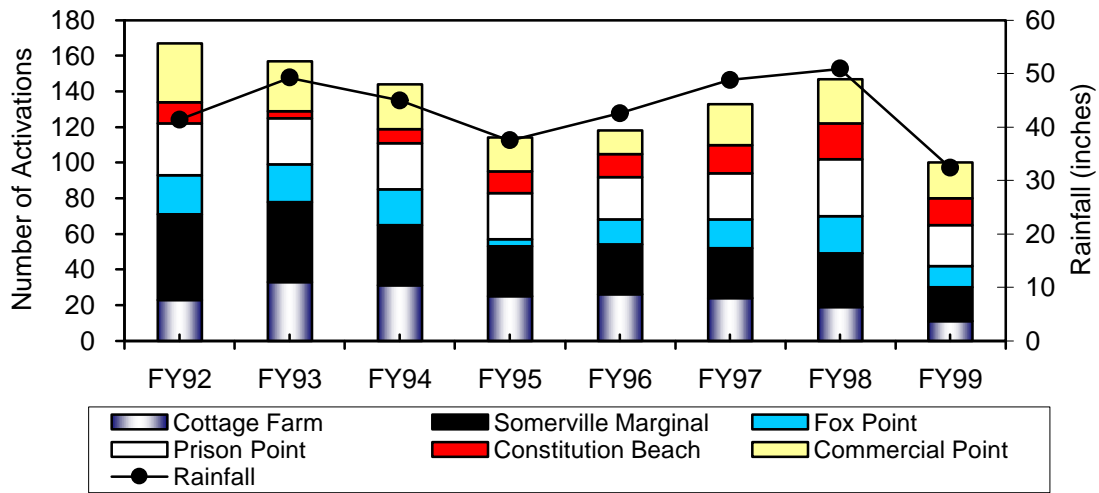
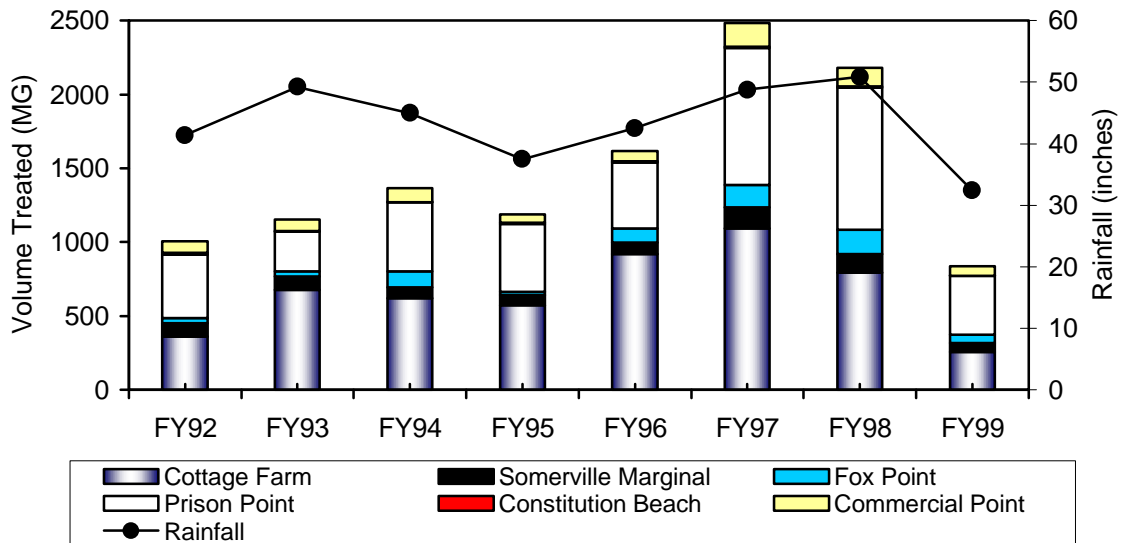
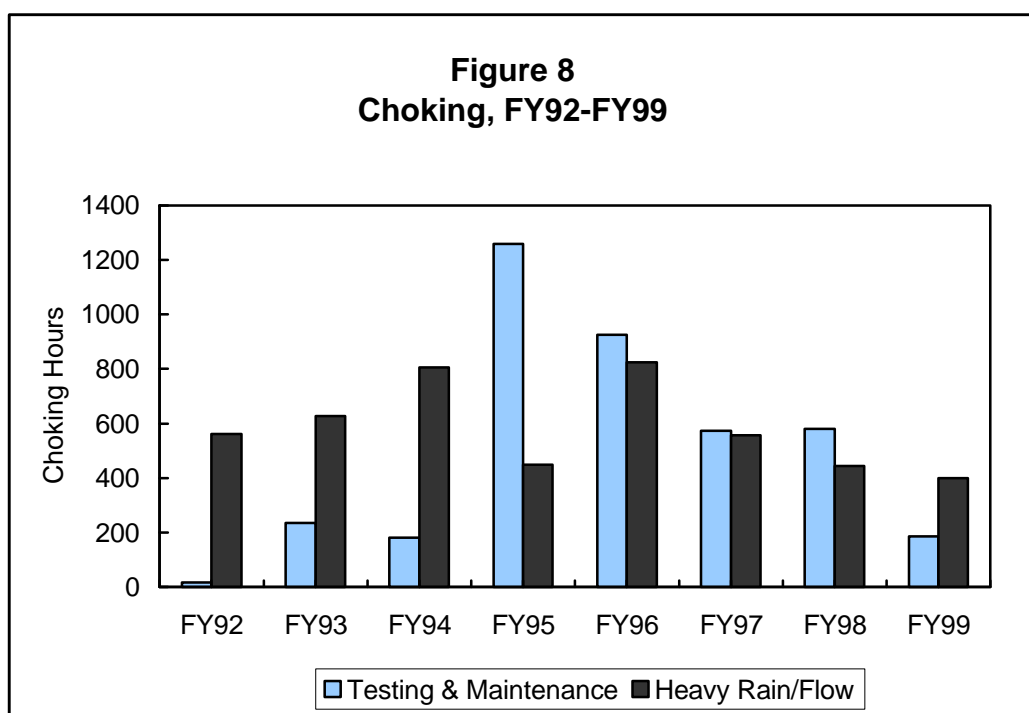

Figure 7
CSO Volume Treated, FY92-FY99



System Capacity

Some of the monitoring performed by MWRA relates to the capacity of the transport and treatment system. One of the system capacity parameters in the North System is choking, which occurs at the remote headworks. Choking is a reduction or stopping of flow to Deer Island, either when heavy flow exceeds the capacity of the treatment plant or when maintenance is performed at the plant.



As Figure 8 shows, the number of hours of choking decreased from FY98 to FY99, with the majority of the choking hours being caused by heavy flows. Maintenance- and testing-related choking is performed at off-peak times and does not cause any backups in the system upstream.

Another system capacity parameter monitored by MWRA is the occurrence of Sanitary System Overflows, or SSOs. These overflows occur in areas where the collection system becomes overloaded by heavy flows. In FY95, the MWRA Transport Department started to locate and visually monitor these SSOs in the North and South Systems. Table 1 summarizes the SSOs observed by MWRA personnel in FY99.

Table 1 Sanitary Sewer Overflows, FY99	
Location	Number of Overflows
<i>North System</i>	
Section C Medford	0
Section 107 Medford	0
Section 91B Medford (Siphon)	0
Section 43.5 Medford	0
Section B Cambridge	0
Section 113 Winchester	0
Section 80 Arlington	0
<i>South System</i>	
Section 126 Weymouth Smelt Brook	3
Section 126 Weymouth (Manhole)	0
Section 128 Braintree (Siphon)	0

Future Outlook

The startup of the new primary treatment plant at Deer Island was just the first of several changes and improvements in MWRA's facilities. In FY98, secondary treatment was implemented at Deer Island. Currently, there are two batteries of secondary treatment, and a third battery is planned for FY00. In the beginning of FY99, the Nut Island facility was decommissioned and South System flows were transported to Deer Island for treatment at the new plant. The new outfall tunnel into Massachusetts Bay is expected to open in FY00. Once this tunnel is opened, DITP will no longer discharge effluent into Boston Harbor.

Effluent discharges from the new outfall tunnel will be regulated under a new NPDES permit. This comprehensive permit, the first of its kind, will include several new concepts. In addition to the usual effluent monitoring, a post discharge ambient monitoring program will be put into place for the new outfall site, as well as a contingency plan to ensure that discharge does not adversely impact Massachusetts Bay. Other requirements will include water conservation measures, pollution prevention plans, and best management practices to stop pollution before it reaches the treatment facility. A stepped-up industrial waste program will help industry meet local limits for pollutants. Intensified sampling at CSO facilities will better characterize the quality of CSO effluent. As MWRA completes its new facilities, the next challenge will be to implement these new programs and provide the Authority-wide coordination needed to meet the new NPDES reporting requirements.

I Introduction

This report presents and summarizes the National Pollutant Discharge Elimination System (NPDES) monitoring and compliance data compiled and analyzed by the Massachusetts Water Resources Authority (MWRA) NPDES Unit during the period of July 1998 to June 1999. MWRA's treatment plant and Combined Sewer Overflow (CSO) facilities serve large communities' needs for sewer systems.

The monitoring results for the Deer Island Treatment Plant are presented and discussed in Chapter II. Chapter III describes the results for the six Combined Sewer Overflow facilities. Chapter IV discusses sewer system capacity. Appendices A-G provide detailed monthly summary data for the Deer Island plants and for the six CSO facilities. Appendix H provides background information about MWRA's regulatory requirements, and Appendix I describes the MWRA sewer system and facilities. Appendix J defines the types of detection limits encountered in chemical analyses. Appendix K includes lists of pollutants of concern. Finally, Appendix L is a glossary of the terms and phrases used throughout this report.

II Deer Island Treatment Plant

This chapter presents and discusses monitoring information for the Deer Island Treatment Plant (DITP). The characteristics examined include flow, conventional parameters, nutrients, priority pollutants (metals, cyanide, pesticides/PCBs, and organic compounds), whole effluent toxicity, and bioaccumulation.

II.A Monitoring Results

II.A.1 Influent Characteristics

II.A.1.a Flow

The average flow to DITP in FY99 was 350 mgd. Figure II.A.1 shows that the amount of flow to the plant is influenced by precipitation. This occurs because several communities in the North System have combined sewers.

The impact of rainfall on flows can also be seen in Figure II.A.2, which tracks average flow and precipitation over the past twelve years. While yearly flows during this period have stayed essentially at the same level, they have followed the same general trend as the variations in yearly rainfall, except for FY99. At the start of this fiscal year, flow from Nut Island was transferred to Deer Island. Since the FY99 data includes flow from the South System, flow increased to a high of 350 MG, although rainfall decreased to a low of 32.4 inches.

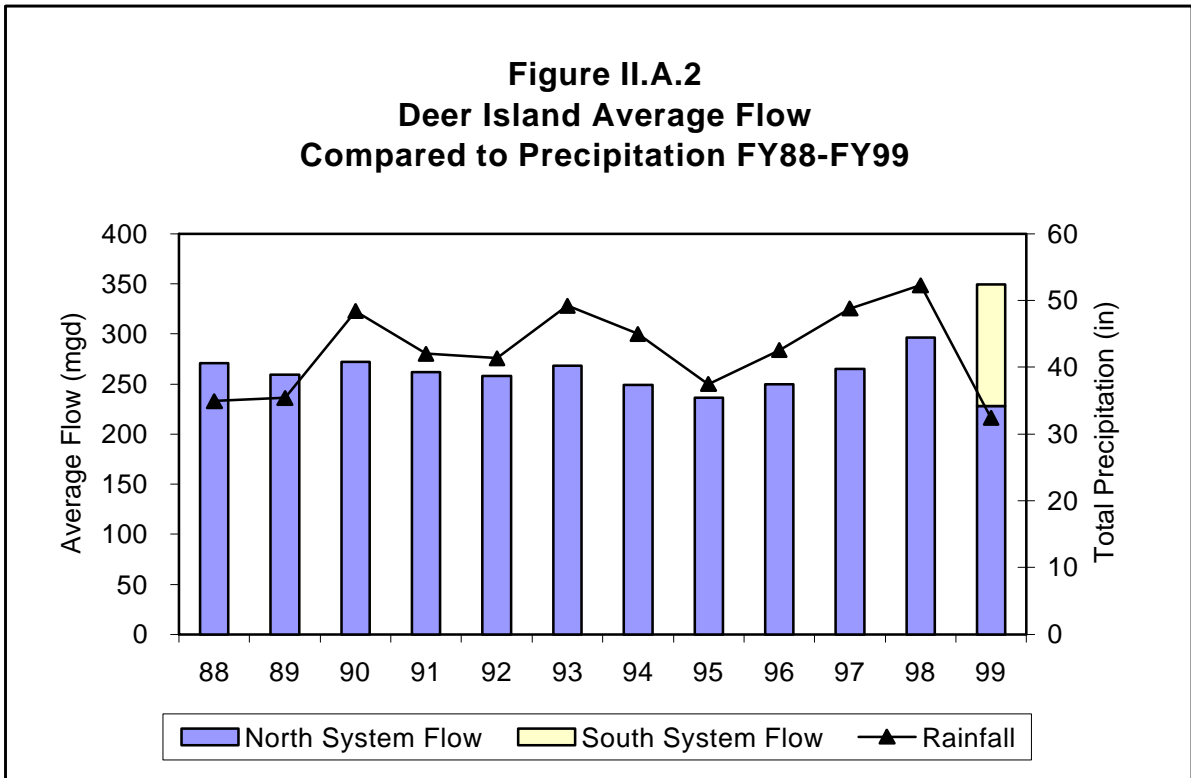
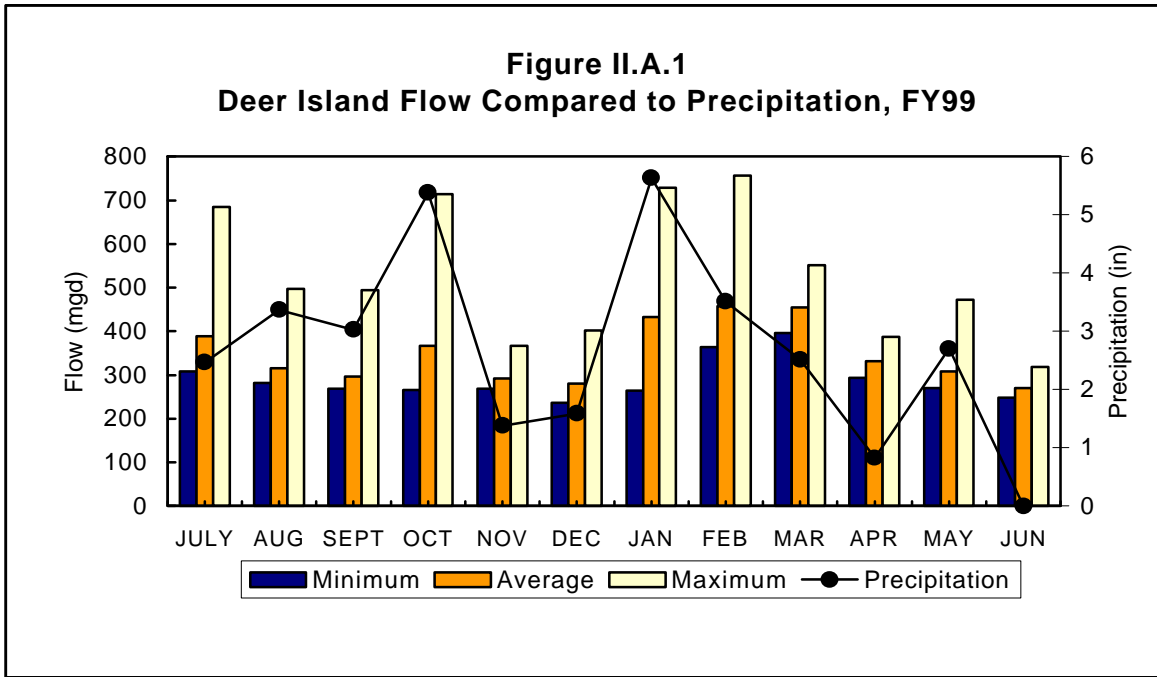
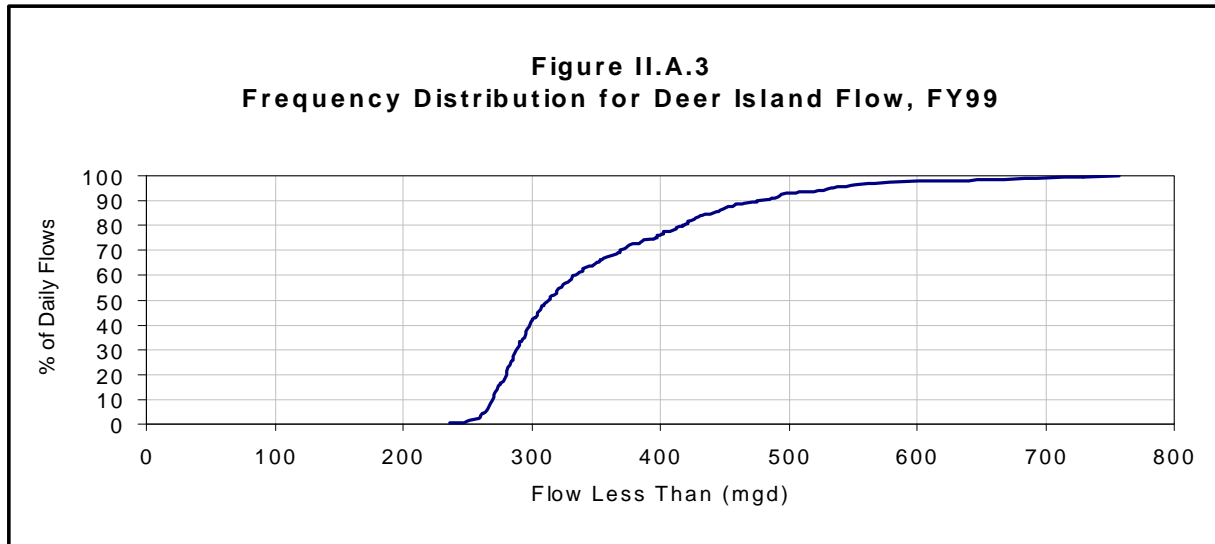

Figure II.A.3 provides a frequency distribution of DITP flow in FY99. Flow through the plant was less than 534 mgd 95% of the time.



II.A.1.b Conventional Parameters and Nutrients

As Table II.A.1 indicates, the FY99 Deer Island influent can be classified as weak/moderate.² A summary of conventional and nutrient concentrations and loadings in Deer Island influent from FY93-FY99 is provided in Table II.A.2. Since the South System flow was transferred from Nut Island to Deer Island in FY99, the influent strength appears to have increased slightly.

²Metcalf & Eddy, Inc. 1972. Wastewater Engineering: Collection, Treatment, Disposal. New York: McGraw-Hill Book Company, p. 231.

Table II.A.1 Classification of Deer Island Influent (mg/L), FY99

Parameter	Value	Weak	Medium	Strong
TSS	160	100	200	350
BOD	151	100	200	300
TKN	20	20	40	85
Ammonia	11	12	25	50
COD	373	250	500	1000

Table II.A.2 Deer Island Influent Characterization, FY93-FY99

PARAMETER	FY93	FY94	FY95	FY96	FY97	FY98	FY99 *
Flow (mgd)							
Minimum	174	171	167	147	167	159	233
Average	266	249	236	250	265	296	350
Maximum	628	528	565	526	649	917	824
Total Suspended Solids (TSS)							
Min Conc (mg/L)	121	93	102	56	50	32	43
Avg Conc (mg/L)	153	137	138	140	144	141	160
Max Conc (mg/L)	193	175	160	432	284	382	564
Average Loading (tons/d)	170	142	136	146	159	175	234
Biochemical Oxygen Demand (BOD)							
Min Conc (mg/L)	123	99	99	61	39	31	45
Avg Conc (mg/L)	159	149	140	143	136	145	151
Max Conc (mg/L)	190	175	173	246	311	302	506
Average Loading (tons/d)	176	155	138	149	151	179	220
Settleable Solids							
Min Conc (mL/L)	1.4	1.9	3.5	0.1	1.5	0.1	0.1
Avg Conc (mL/L)	3.7	3.9	5.6	7.0	6.9	6.3	5.9
Max Conc (mL/L)	5	5.6	7.3	18.0	17.0	20.0	34.2
Average Loading (tons/d)	4.1	4.0	5.5	7.3	7.7	7.8	8.6
Oil and Grease							
Min Conc (mg/L)	20	14	17	10	12	7	15
Avg Conc (mg/L)	43	36	31	34	29	30	37
Max Conc (mg/L)	84	64	37	67	136	108	107
Average Loading (tons/d)	48	37	31	35	33	36	54
Total Kjeldahl Nitrogen							
Min Conc (mg/L)	13.9	11.2	14.0	11.6	8.7	13.6	14.6
Avg Conc (mg/L)	26.9	21.9	21.9	26.3	24.2	26.4	29.2
Max Conc (mg/L)	44.7	29.3	29.1	56.3	48.1	37.7	45.6
Average Loading (tons/d)	29.8	22.7	21.5	27.4	26.8	32.6	42.7

Table II.A.2 Deer Island Influent Characterization, FY93-FY98 [cont.]

PARAMETER	FY93	FY94	FY95	FY96	FY97	FY98	FY99 *
Ammonia-Nitrogen							
Min Conc (mg/L)	6.8	5.6	7.3	6.8	2.5	4.8	6.0
Avg Conc (mg/L)	13.4	12.3	13.7	15.0	13.3	14.5	16.6
Max Conc (mg/L)	17.9	17.9	18.0	24.0	18.6	23.1	30.8
Average Loading (tons/d)	14.9	12.8	13.5	15.6	14.6	17.8	24.2
Nitrates							
Min Conc (mg/L)	0.13	0.10	0.02	0.01	0.01	0.01	0.01
Avg Conc (mg/L)	0.7	0.80	0.15	0.14	0.22	0.36	0.06
Max Conc (mg/L)	2.15	2.70	0.59	1.42	2.31	1.95	1.21
Average Loading (tons/d)	0.78	0.83	0.15	0.15	0.24	0.44	0.09
Nitrites							
Min Conc (mg/L)	0.02	0.00	0.02	0.01	0.01	0.01	0.01
Avg Conc (mg/L)	0.06	0.10	0.06	0.07	0.09	0.08	0.05
Max Conc (mg/L)	0.13	0.20	0.19	1.66	0.35	0.46	0.45
Average Loading (tons/d)	0.07	0.10	0.06	0.07	0.10	0.10	0.07
Orthophosphorus							
Min Conc (mg/L)	2.04	0.40	1.00	0.29	0.13	0.49	0.50
Avg Conc (mg/L)	2.04	2.30	2.20	1.53	1.49	1.76	2.02
Max Conc (mg/L)	2.04	5.10	5.66	3.19	2.62	3.13	3.25
Average Loading (tons/d)	2.26	2.39	2.17	1.60	1.64	2.17	2.95
Total Phosphorus							
Min Conc (mg/L)	2.63	0.60	2.11	1.54	1.21	1.80	2.25
Avg Conc (mg/L)	6.04	4.00	3.63	3.42	3.19	3.70	4.22
Max Conc (mg/L)	9.07	8.30	4.79	4.85	5.00	5.29	7.78
Average Loading (tons/d)	6.7	4.15	3.57	3.57	3.53	4.57	6.16

* Since South System flow was transferred from Nut Island to Deer Island at the start of FY99, the data for this year includes the flows from both the North and South systems.

II.A.1.c Priority Pollutants

The results of a complete priority pollutant scan of Deer Island influent can be found in Table A-2 (concentrations) and Table A-3 (loadings) of Appendix A. For levels below detection limits, one half of the method detection limit for inorganics, and one tenth of the quantitation limit for organics was substituted. A discussion of detection and quantitation limits can be found in Appendix K.

FY99 influent average loadings for several key metals are compared to historical values in Figure II.A.4. Before 1999, metals loadings had decreased over the past several years. Causes for the decrease include toxics control measures and in the last couple of years, corrosion control efforts. Since the South System flow was transferred from Nut Island to Deer Island at the start of FY99, the data for this fiscal year includes the South System flow and was obtained from Table A-3 of Appendix A. This combined flow explains the increase in metals loadings from previous years to FY99.

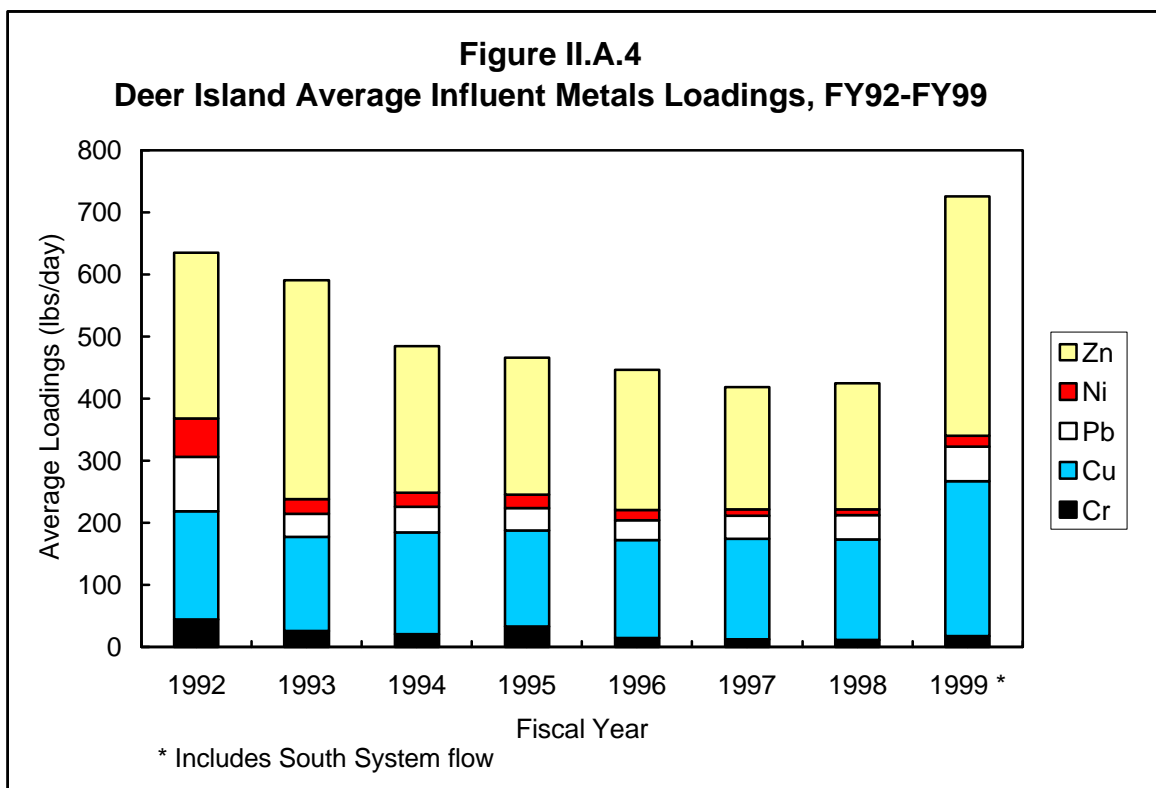
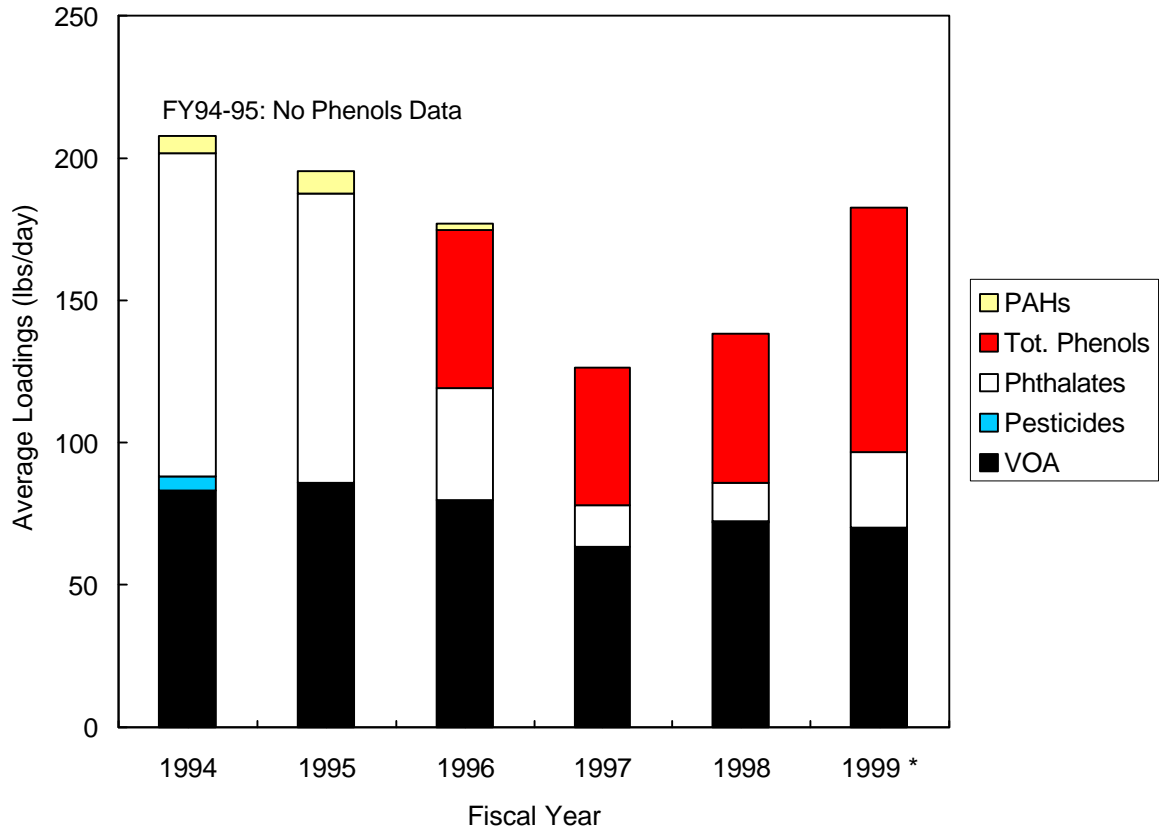

Figure II.A.5 compares influent loadings of certain representative organic priority pollutants to the loadings in previous years. (See Table A-3 in Appendix A for more details). Three discreet samples of these pollutants are taken a few times a month. The daily load can then be calculated from the measured concentration and the flow on the day during which the sample was taken. Since the South System flow was transferred from Nut Island to Deer Island at the start of FY99, the data for this fiscal year includes the South System flow. This combined flow explains the increase in organics loadings from FY98 to FY99.

Figure II.A.5 shows the annual average of the daily loads (lbs/day) for the past six fiscal years. The figure includes the average loads of those pollutants that were detected at least once. However, it does not reflect how often the pollutant was detected during the year. For example, if in FY99, a pollutant was detected twice out of 35 tests, the pollutant's average daily loading for the year would be included in the chart below. If in FY98, that same pollutant was detected 34 out of 35 times, the average loading would be included in the chart below, without differentiating it from FY99. Moreover, the average loading of a pollutant may be artificially high, since when the pollutant is not detected, one tenth of the reporting limit is listed (see Appendix K). Therefore, when this concentration is converted to a loading, it is recorded as a non-zero value, even though the constituent may not have been present in the sample.

Figure II.A.5
Deer Island Average Influent Organics Loadings, FY94-FY99



II.A.2 Effluent Characteristics

II.A.2.a Conventional Parameters

Table II.A.3 compares DITP's removal efficiencies for TSS and BOD with theoretical removal efficiencies.³

Parameter	DITP Removal Efficiency*	Theoretical Removal Efficiency	
		Primary Treatment	Secondary Treatment
TSS	87%	50-65%	85%
BOD	80%	25-40%	85%

*Removal efficiencies were determined using the average influent and effluent concentration values as reported in Table A-1, Appendix A. Note that only a portion of the total flow each month went through secondary treatment. See Table II.A.4 for more information.

Table II.A.4 shows how the TSS and BOD removal efficiencies may be affected by the degree of secondary treatment. The table lists the TSS and BOD removal efficiencies and the percentage of flow that received secondary treatment on a monthly basis. The removal efficiencies are determined from the average effluent and influent concentrations for TSS and BOD as reported in Table A-1 of Appendix A. The degree of secondary treatment is the average flow through secondary treatment (mgd) during the month divided by the average plant flow (mgd) for that month.

For most of the year, more than 85% of DITP flow went through secondary treatment and removal efficiencies were greater than 80%. In October and January, flows to Deer Island were unusually high due to increased precipitation. Therefore, a lower percentage of flow could be sent to secondary treatment, resulting in reduced removal efficiencies.

³Metcalf & Eddy, Inc. 1972. Wastewater Engineering Collection, Treatment, Disposal. New York. McGraw-Hill Book Company, p. 446.

	TSS Removal Efficiency	BOD Removal Efficiency	% of Flow Treated at Secondary Levels
July	93%	89%	98%
August	93%	90%	100%
September	89%	81%	86%
October	89%	85%	92%
November	91%	87%	100%
December	92%	83%	99%
January	92%	87%	96%
February	86%	83%	89%
March	78%	76%	84%
April			
May			
June			

Table II.A.5 summarizes the conventional parameters and nutrients in Deer Island effluent over the past seven years. The significant drop in several parameters that occurred between FY95 and FY96 is due to the improved removal efficiency of the primary treatment plant. The implementation of secondary treatment in FY98 can explain the drop in TSS and BOD concentrations since FY97. It can also explain the increase in TKNs, ammonia and nitrites.

Table II.A.5 Deer Island Effluent Characterization, FY93-FY99

PARAMETER	FY93	FY94	FY95	FY96	FY97	FY98	FY99 *
Flow (mgd)							
Minimum	174	171	167	147	167	159	237
Average	266	249	236	250	265	296	350
Maximum	628	528	565	526	649	917	757
Total Suspended Solids (TSS)							
Min Conc (mg/L)	58	65	52	17	16	4	3
Avg Conc (mg/L)	70	73	65	44	41	25	22
Max Conc (mg/L)	77	86	90	136	100	140	69
Average Loading (tons/d)	78	76	64	46	46	31	31
Biochemical Oxygen Demand (BOD)							
Min Conc (mg/L)	89	87	85	42	29	8	10
Avg Conc (mg/L)	128	123	116	98	93	39	30
Max Conc (mg/L)	152	142	138	147	191	216	99
Average Loading (tons/d)	142	128	114	102	103	48	44
Settleable Solids							
Min Conc (mL/L)	0.1	0.1	0.1	0.1	0.1	0.1	0.1
Avg Conc (mL/L)	0.3	0.5	0.4	0.2	0.2	0.2	0.2
Max Conc (mL/L)	0.5	0.9	0.7	2.0	1.6	7.0	3.0
Average Loading (tons/d)	3.3	0.5	0.4	0.2	0.2	0.2	0.3
Oil and Grease							
Min Conc (mg/L)	15	12	17	7	7	4	7
Avg Conc (mg/L)	27	25	25	24	23	11	10
Max Conc (mg/L)	37	36	30	42	47	30	28
Average Loading (tons/d)	30	26	25	25	26	13	15
Total Kjeldahl Nitrogen							
Min Conc (mg/L)	14.9	12.8	13.7	10.6	10.9	9.1	11.2
Avg Conc (mg/L)	22.2	21.7	23.0	22.5	21.9	20.4	23.4
Max Conc (mg/L)	26.2	32.8	28.6	32.5	27.6	32.4	34.3
Average Loading (tons/d)	24.6	22.5	22.6	23.4	24.3	25.2	34.2

Table II.A.5 Deer Island Effluent Characterization, FY93-FY99 [cont.]

PARAMETER	FY93	FY94	FY95	FY96	FY97	FY98	FY99 *
Ammonia-Nitrogen							
Min Conc (mg/L)	7.59	6.08	7.28	5.55	4.43	3.48	5.42
Avg Conc (mg/L)	12.35	12.58	14.43	14.48	13.07	15.08	17.99
Max Conc (mg/L)	15.70	18.51	19.60	21.90	18.00	22.70	26.40
Average Loading (tons/d)	13.70	13.06	14.20	15.10	14.45	18.63	26.23
Nitrates							
Min Conc (mg/L)	0.05	0.13	0.03	0.01	0.01	0.01	0.01
Avg Conc (mg/L)	0.66	1.04	0.08	0.30	0.34	0.42	0.22
Max Conc (mg/L)	1.63	5.98	0.28	1.95	2.58	1.49	1.93
Average Loading (tons/d)	0.73	1.08	0.08	0.31	0.37	0.52	0.32
Nitrites							
Min Conc (mg/L)	0.02	0.01	0.02	0.01	0.01	0.01	0.01
Avg Conc (mg/L)	0.16	0.10	0.08	0.63	0.11	0.20	0.30
Max Conc (mg/L)	0.48	0.26	0.22	1.90	0.62	1.15	1.99
Average Loading (tons/d)	0.18	0.10	0.08	0.66	0.12	0.25	0.44
Orthophosphorus							
Min Conc (mg/L)	0.98	0.48	0.90	0.37	0.48	0.48	0.71
Avg Conc (mg/L)	2.27	2.15	2.22	1.71	1.68	1.71	1.97
Max Conc (mg/L)	3.59	4.09	3.39	3.01	2.71	3.18	3.19
Average Loading (tons/d)	2.52	2.23	2.18	1.78	1.85	2.11	2.87
Total Phosphorus							
Min Conc (mg/L)	2.03	1.19	2.11	1.43	1.12	1.17	1.50
Avg Conc (mg/L)	3.64	2.92	3.35	2.92	2.94	2.77	2.93
Max Conc (mg/L)	4.71	5.18	4.35	4.13	3.98	7.74	4.30
Average Loading (tons/d)	4.04	3.03	3.30	3.04	3.24	3.42	4.27

* Since South System flow was transferred from Nut Island to Deer Island at the start of FY99, the data for this year includes the flows from both the North and South systems.

II.A.2.b Nutrients

A summary of nutrient concentrations in Deer Island effluent from FY93-FY99 is provided in Figure II.A.6. There have not been any major changes in nutrient concentrations over the past several years. The introduction of the new primary treatment plant in FY95 did not affect nutrient concentrations, because primary treatment does not remove nutrients. Since the introduction of secondary treatment in FY98, there has been a slight increase in the ammonia-nitrogen levels in the effluent.

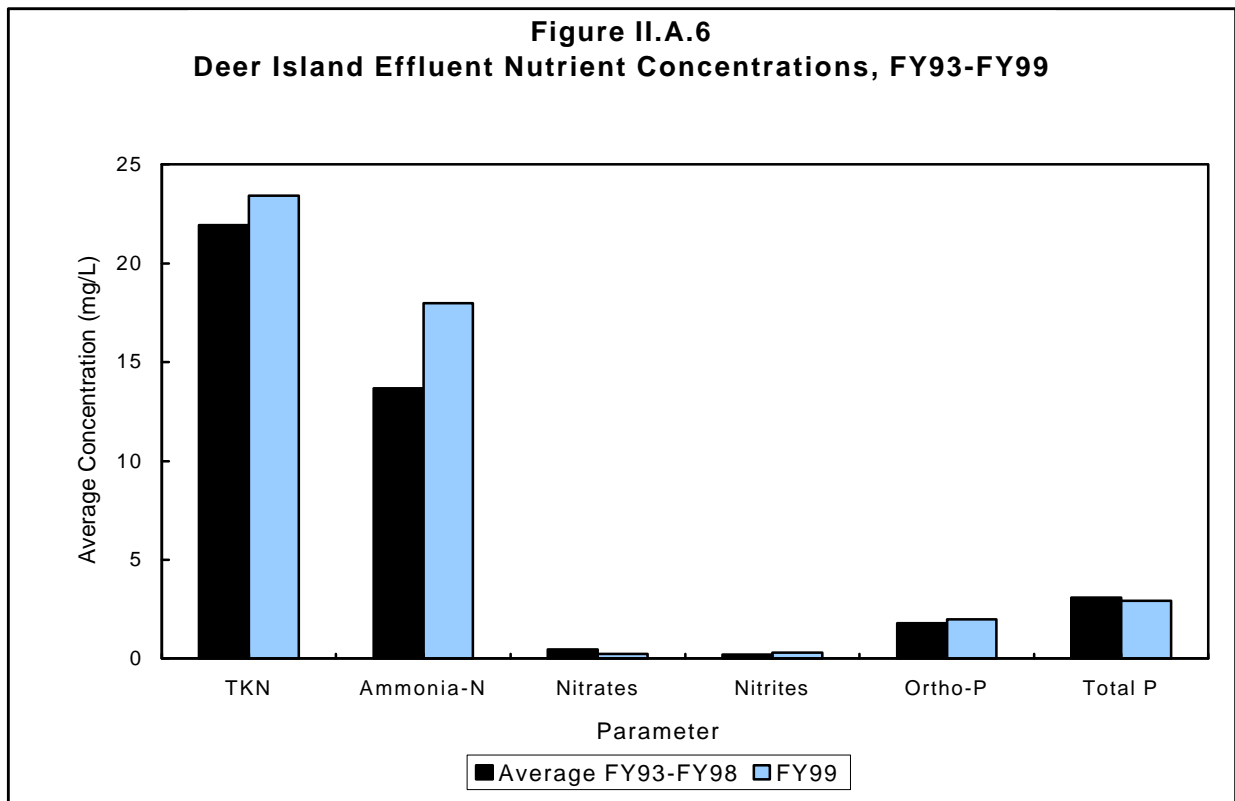

II.A.2.c Priority Pollutants

A summary of priority pollutant concentrations and loadings in DITP effluent for FY99 is provided in Appendix A, Tables A-8 and A-9. Metals loadings over the past eleven years are summarized in Figure II.A.7, while organic pollutants from FY94-FY99 are graphed in Figure II.A.8. (See Section II.A.1.c for a discussion of the organics loading data.) As can be expected with primary treatment, generally the same metals and other priority pollutants were detected in the effluent as were found in the influent. The gradual decrease in loadings over the past few years reflects the decrease in

loadings in the influent during the same time period. It may also be attributed to better capture of the metals at the plant.

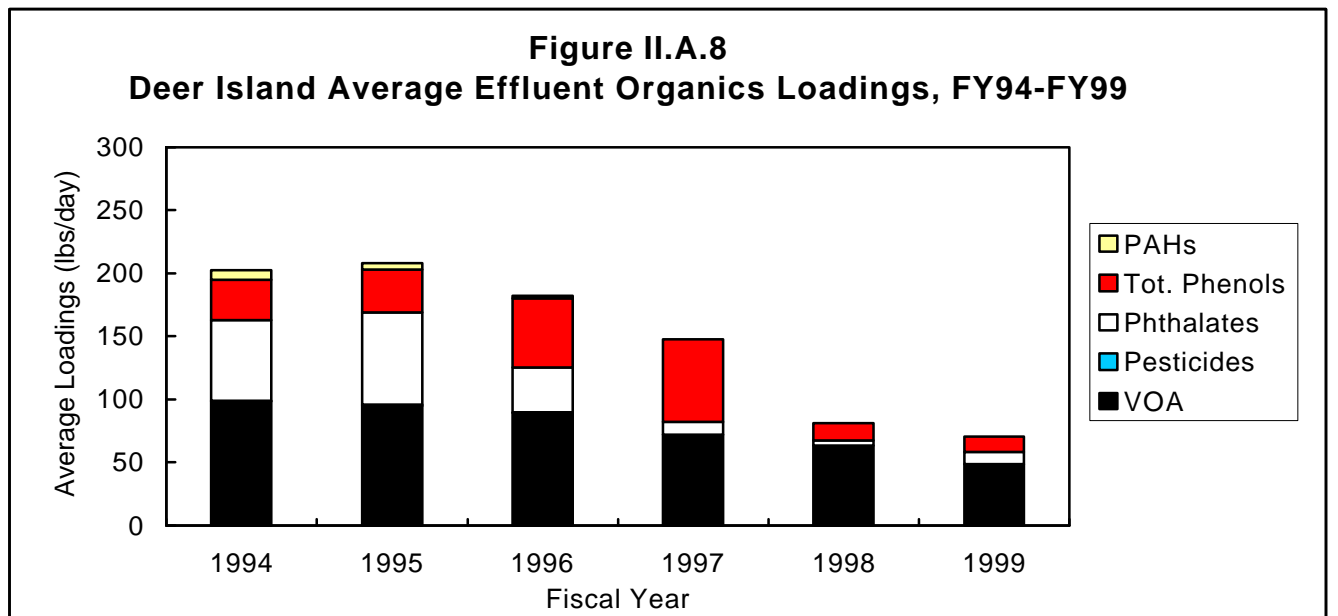
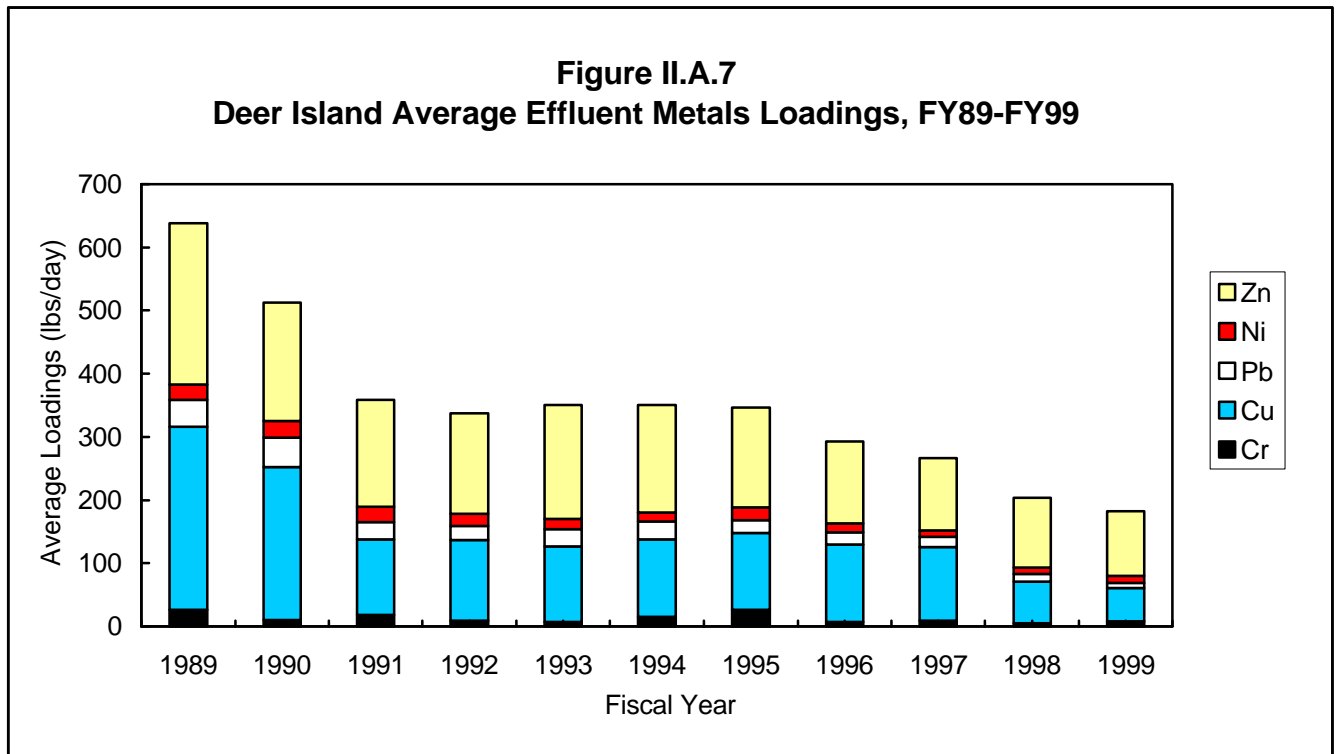

II.A.2.d Whole Effluent Toxicity

MWRA tests effluent toxicity every month at the Deer Island Plant. Effluent toxicity provides an overall view of the quality of the effluent, to ensure that the effluent does not adversely affect the environment. In 1989, the EPA found that the probable cause of most acute toxicity in DITP's wastestream was due to surfactants. Surfactants are most commonly used in household detergents to improve cleansing power. No acute toxicity could be attributed to metals or pesticides.

MWRA is required to use three tests for effluent toxicity. A 96-hr acute static toxicity test using mysid shrimp (*Mysidopsis bahia*) measures the short term lethal effects caused by the effluent. A chronic survival and growth test using the sheepshead minnow (*Cyprinodon variegatus*) and a chronic reproduction test using a red algae (*Champia parvula*) both measure subtle toxic impacts over a longer period of time. The results of these tests can be found in Table II.A.6.

The LC50 (Lethal Concentration 50%) is the concentration of effluent in a sample that causes mortality to 50% of the test population during the duration of the test. The NOEC (No Observed Effect Concentration) is the concentration of effluent in a sample to which organisms are exposed in a life cycle or partial life cycle test which has no adverse effects. An NOEC limit of 20% means that 20% of the sample contains effluent, and the remainder is dilution water. Any acute NOEC below 20% or chronic NOEC below 10% would violate the NPDES limits.

Reductions in toxicity at DITP in FY99 reflect the benefits of secondary treatment. The acute results were in compliance 100% of the time and the *Cyprinodon* chronic tests were in compliance 92% of the time. The results of the *Champia* chronic tests were never in compliance. Due to questions regarding *Champia*'s reliability, Region I EPA has withdrawn this species as a monitoring tool in all permit renewals.

Table II.A.6					
Deer Island Effluent, Results of Toxicity Testing, FY99					
	<u>Mysid Shrimp acute</u>		<u>Sheepshead Minnow chronic</u>		<u>Red Algae chronic</u>
	LC50	NOEC	Survival NOEC	Growth NOEC	NOEC
Limits (%)	None	20	10	10	10
July	>100	50	100	60	2.0
August	96	50	100	100	2.0
September	>100	50	20	20	0.7
October	78	50	60	60	2.0
November	>100	100	100	<5	0.2
December	>100	50	100	60	2.0
January	>100	100	100	60	0.2
February	>100	50	60	60	0.2
March	>100	50	100	100	<0.2
April	>100	100	40	40	<0.2
May	100	50	100	60	0.2
June	100	50	60	60	0.7
FY99 Average	98	63	78	57	0.9
# of Violations	0	0	0	1	12

Results in **bold** indicate a violation of the regulatory limits

II.A.2.e Bioaccumulation Study

Bioaccumulation studies measure the potential for long-term buildup of pollutants in aquatic species. In the summer of 1998, MWRA conducted a mussel bioaccumulation study for DITP effluent designed to be comparable to studies conducted in 1987 and from 1991 to 1997. The results of this study can be found in Table II.A.7 (lead and mercury) and Table II.A.8 (other contaminants).

In 1998, mussels were collected from relatively clean sites in Gloucester and Sandwich and deployed for 60 days. The caged mussels were deployed at the Deer Island effluent discharge, at the proposed

offshore discharge site in Massachusetts Bay (for pre-discharge baseline data), at the New England Aquarium in Boston's Inner Harbor (dirty control) and in Central Cape Cod Bay. In order to assess changes in water quality resulting from cessation of the Nut Island discharge, mussels were also deployed in Quincy Bay in the zone of initial dilution of Nut Island's old effluent discharge. Upon retrieval, mussels were analyzed for pesticides (chlordanes, DDT and dieldrin), PCBs, both petrogenic (Low Molecular Weight) and pyrogenic (High Molecular Weight) polyaromatic hydrocarbons (PAHs), mercury and lead. Results were statistically compared to pre-deployment mussels for organics (Gloucester) and pre-deployment levels for metals (Sandwich). Mussels deployed in Quincy were statistically compared to pre-deployment mussels for both organics and metals (Sandwich). Due to lost deployments at Deer Island and at the future outfall site, mussels collected at 40 days were analyzed and statistically compared. Previous studies indicate that in 40 days, mussels accumulate close to 90% of the body burden as those deployed for 60 days.

Sandwich pre-deployed mussels showed a pattern of statistically higher PCBs and pesticides than Gloucester mussels, while the reverse was true for PAHs. In general, mussels deployed at the future outfall site and at Cape Cod Bay were significantly lower than the pre-deployment mussels. Only total chlordanes at the future outfall site were inexplicably higher than the controls.

The mussels at Boston's Inner Harbor had numerically higher concentrations of all contaminants than other sites. With the exception of mercury, the mussels had significantly greater concentrations of all contaminants compared to the controls.

Deer Island mussels showed significantly greater body burdens of PCBs and pesticides than the Gloucester controls, but significantly lower concentrations of LMW PAHs. This continues a long-term decrease in the body burden of LMW PAHs at Deer Island. Effluent data have shown that most PAHs in the Deer Island discharge are petrogenic PAHs and that they represent a major continuing source into the harbor. Mussel data suggest that the Deer Island contribution is now at or below background.

Quincy Bay mussels significantly accumulated total PCBs, HMW PAHs and total chlordanes above the already high levels of the Sandwich mussels. For most contaminants, the body burdens at Quincy Bay were higher than those at Deer Island and were not greatly changed from levels reported in 1987. This suggests that there are major sources of these contaminants to the Quincy Bay area, other than Nut Island.

Table II.A.7 Concentrations of Metals Bioaccumulating in Boston Harbor Mussels

	Pre-Deployment*	Clean Control*	Dirty Control*	Deer Island	Nut Island	Cape Cod
Lead (ug/g)						
1987	2.8	3.1		6.7**	8.3**	
1991	6.5	5	6.4	5.9		
1993	5.1	3.7**		5.9		
1994	8.6	4.8**	6.7	9.1		
1995	6.1	DL	8.5**	8		
1996	2.9	1.6	9.4**	6.3**		
1997	2.4	2.1	9.9**	7.8**		
1998	2.9	2.1	4.1***	3.5	3.3	2
Mercury (ug/g)						
1993	0.39	0.10**		0.18**		
1994	0.26	0.13	0.16	0.21		
1995	0.064	DL	0.068	0.056		
1996	0.13	0.15	0.13	0.15		
1997	0.17	0.10	0.32	0.06**		
1998	0.1	0.09	0.11	0.01	0.01	0.07

* Mussels collected from Cape Cod in 1987 and 1995 to 1997, Gloucester in 1991 to 1994, and Sandwich in 1998.

Clean control at proposed offshore discharge in 1987, 1992 to 1998 and in Gloucester in 1991.

Dirty control at New England Aquarium.

All deployments were for 60 days except 1995, which was for 50 days.

** Statistically different (p<0.05) from pre-deployment.

*** Statistically greater than pre-deployment.

DL = Deployments lost due to entanglement with fishing gear.

Table II.A.8 Concentrations of Contaminants Bioaccumulating in Boston Harbor Mussels

	Pre- Deployment*	Clean Control*	Dirty Control*	Deer Island	Nut Island	Cape Cod Bay
Total PCBs (ng/g)						
1987	317	227		630**	604**	
1991	77	77	477**	199**		
1992	65	44**	652**	133**		
1993	AP	110	596**	321**		
1994	107	89	500**	161**		
1995	94	DL	441**	172**		
1996	160	102	538**	273**		
1997	136	101	785**	360**		
1998	63; 79	59	460***	149***	272***	49
Total DDTs (ng/g)						
1987	52	30		63	51	
1991	28	28	94**	48**		
1992	15	12	103**	25**		
1993	AP	30	130**	63**		
1994	27	19	86**	50**		
1995	29	DL	92**	45**		
1996	58	30	119**	85**		
1997	53	23**	136**	61		
1998	34; 56	20	82***	38***	51	16
Alpha - Chlordane (ng/g)						
1987	8.7	6.7		21.5**	19.5**	
1991	2.4	2.5	19.0**	10.3**		
1992	1.9	1.7	19.0**	6.9**		
1993	2.9	3.8	10.5**	8.2**		
1994	3.5	3.6	12.8**	13.8**		
1995	2.6	DL	11.7**	7.5**		
1996	4.8	3	15.8**	20.0**		
1997	4.4	2.9**	14.0**	10.4**		
1998	7; 14	11**	26***	25***	23***	8
Dieldrin (ng/g)						
1987	6.6	3.6		11.4	7.6	
1991	<1.4	2.3	9.0**	2.9		
1992	<1.0	1.2	6.7**	2.7		
1993	<2.9	2.2	4.5**	34		
1994	<1.2	2	15.6**	10.4**		
1995	1.5	DL	6.9**	3.2**		
1996	0.5	1.7	9.3**	5.6**		
1997	2.3	2.0	7.1**	3.4**		
1998	2.8; 5.7	2.3	7.6***	4.1***	5.6	2.8
Lindane (ng/g)						
1987	1.8	0.8		5.5	0.8	

Table II.A.8 Concentrations of Contaminants Bioaccumulating in Boston Harbor Mussels [cont.]

	Pre-Deployment*	Clean Control*	Dirty Control*	Deer Island	Nut Island	Cape Cod Bay
Trans-Nonachlor (ng/g)						
1987	7.7	6.2		18.0**		
1991	<1.4	<1.5	<2.5	8.9**		
1992	2.1	2.5	21.3**	8.3**		
1993	4.8	4	11.0**	10.7**		
1994	4	3.8	11.0**	11.2**		
1995	0.6	DL	9.0**	4.2**		
1996	5	4	13.8**	17.0**		
1997	4.4	3.2	14.6**	9.4**		
Total PAHs (ng/g)						
1987	581	465		2344**	683	
1991	217	228	2570**	1207**		
1992	216	129**	3545**	1934**		
1993	188	166	1321**	665**		
1994	264	122	2255**	848**		
1995	214	DL	1444**	761**		
1996	402	142**	2500**	1230**		
1997	157	86**	1493**	346**		
1998	243; 124	58	2047***	217	239***	40
LMW PAHs (ng/g)						
1987				1221		
1991	113	74	239**	516**		
1992	80	61	199**	427**		
1993	66	66	110	169**		
1994	106	61	79	217**		
1995	105	DL	206**	340**		
1996	195	70	268	431**		
1997	68	58	148**	85		
1998	104; 66	19	182***	63	48	19
HMW PAHs (ng/g)						
1987				1123		
1991	104	154	2330**	691**		
1992	136	69	3347**	1507**		
1993	122	101	1210**	496**		
1994	158	61	2174**	631**		
1995	109	DL	1238**	421**		
1996	207	70	2233**	799**		
1997	89	28**	1345**	261**		
1998	139; 58	39	1865***	154	191***	21

Hexachlorobenzene, heptachlor, aldrin, heptachlor epoxide, and mirex not detected or detected near detection limit at all stations.

* Mussels collected from Cape Cod in 1987, Gloucester in 1991 to 1998, and also Sandwich in 1998. For 1998, first value represents Gloucester concentrations and second value represents Sandwich concentrations.

Clean control at proposed offshore discharge in 1987, 1992 to 1998 and in Gloucester in 1991.

Dirty control at New England Aquarium.

In 1987 mussels deployed for 30 days; in 1992-94 and 1996-98 for 60 days; in 1995 for 50 days.

** Statistically different (p<0.05) from pre-deployment.

*** Statistically greater than pre-deployment. Values are compared to Gloucester concentrations except for Nut Island which is compared to Sandwich concentrations.

DL = Deployment lost due to entanglement with fishing gear

AP = Analytical Problems - No Data

II.B Discussion

II.B.1 Compliance with Regulatory Limits

MWRA currently operates under a court order which provides interim discharge limits for the existing Deer Island Treatment Plant. Plant performance at Deer Island is compared to regulatory (interim) limits in Table II.B.1 and Figures II.B.1 through II.B.6. The only violations of the regulatory limits in FY99 were for toxicity testing (see Table II.A.6).

Table II.B.1 Deer Island Effluent Quality Compared to Interim Limits			
Parameter	Interim Limits*	Range of Values Exceeding Limits	Number of Violations
Biochemical Oxygen Demand			
Monthly Avg (mg/L)	140	N/A	0
Daily Max (mg/L)	200	N/A	0
12-mo running removal rate (%)	27	N/A	0
Total Suspended Solids			
Monthly Avg (mg/L)	110	N/A	0
Daily Max (mg/L)	180	N/A	0
12-mo running removal rate (%)	38	N/A	0
Settleable Solids (mL/L)	2.8	N/A	0
Fecal Coliform (col/100 mL)	200	N/A	0
Total Coliform (col/100 mL)	1000	N/A	0
pH	6.5 - 8.5	N/A	0**
PHCs Effluent Dly. Max (mg/L)	15	N/A	0
Toxicity	@	<0.2 - <5	13
Total Number of Violations			13
* Except for removal rates, the effluent quality must be equal to or less than the limits. Removal rates must be equal to or greater than the limits.			
** The minimum limit of 6.5 for pH was violated 70 times during FY99 due to the secondary treatment systems. As expected with the operation of the pure oxygen system, pH of the effluent was lowered as excess CO ₂ (a result of biomass respiration) dissolved into the effluent. Since the violations were a direct result of the treatment process, they can be qualified. The new NPDES permit accounts for the expected lower pH by expanding the limits to 6.0-9.0. The lowered pH has no measurable impact on water quality because of the buffering capacity of the marine receiving waters.			
@ See Table II.A.6			

Table II.B.2 compares the number of NPDES violations in FY99 to previous years.

Table II.B.2 NPDES Violations at Deer Island, FY94-FY99						
	FY94	FY95	FY96	FY97	FY98	FY99
BOD	16	12	7	0	1	0
TSS	1	1	0	0	0	0
Settleable Solids	0	0	0	0	0	0
Fecal Coliform	0	0	0	0	0	0
Total Coliform	0	1	0	0	0	0
pH	1	1	0	0	0	0
PHCs	1	4	5	0	0	0
Toxicity	11	17	19	16	11	13
Non-Toxicity Violations	19	19	12	0	1	0
Total Violations	30	36	31	16	12	13

For biochemical oxygen demand (BOD) and total suspended solids (TSS), limits are placed on the daily maximum concentration, monthly average concentration and on the removal rate.⁴ The removal rate limit is for a 12-month running average of removal rates, rather than for the removal rate for an individual month. As can be seen from Figures II.B.1 and II.B.2, the monthly averages for BOD and TSS never exceeded the regulatory discharge limits (140 mg/L for BOD and 110 mg/L for TSS). Similarly, the 12-month running average removal rates for both TSS and BOD were always well above the regulatory minimum requirements.

⁴A removal rate for a constituent is defined as the influent concentration minus the effluent concentration, divided by the influent concentration.

Figure II.B.1
Deer Island Treatment Plant Effluent
BOD Trend Analysis, FY99

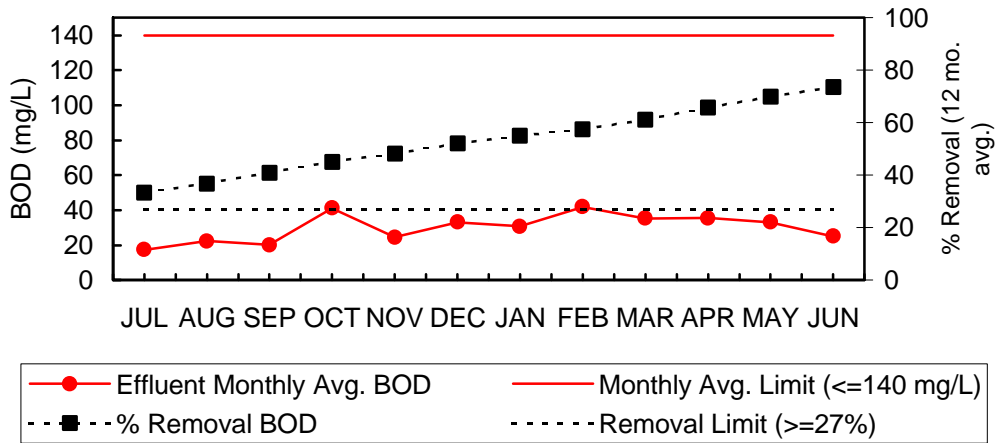
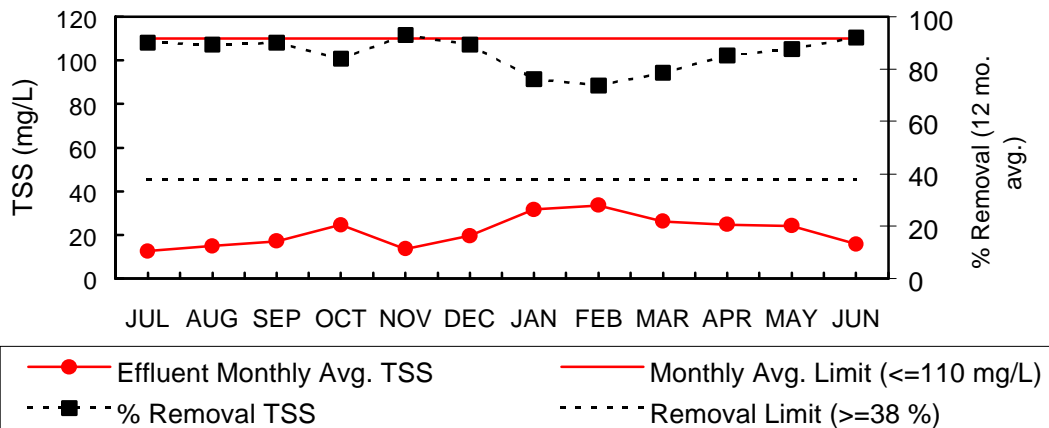
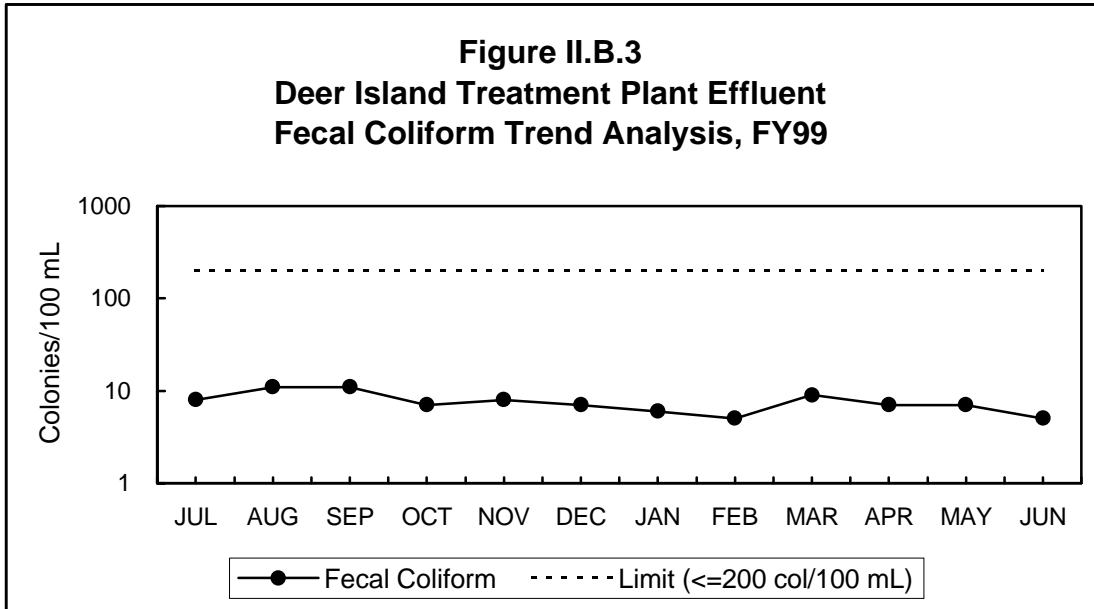

Figure II.B.2
Deer Island Treatment Plant Effluent
TSS Trend Analysis, FY99



For fecal coliform, the monthly geometric mean of the count has a discharge limit of 200 colonies/100 mL. The results for Deer Island were well below this limit, with the monthly geometric mean never exceeding 11 colonies/100 mL.



Likewise, total coliform counts were well below the limit of 1000 colonies/100 mL. The highest monthly geometric mean was 245 colonies/100 mL in March.

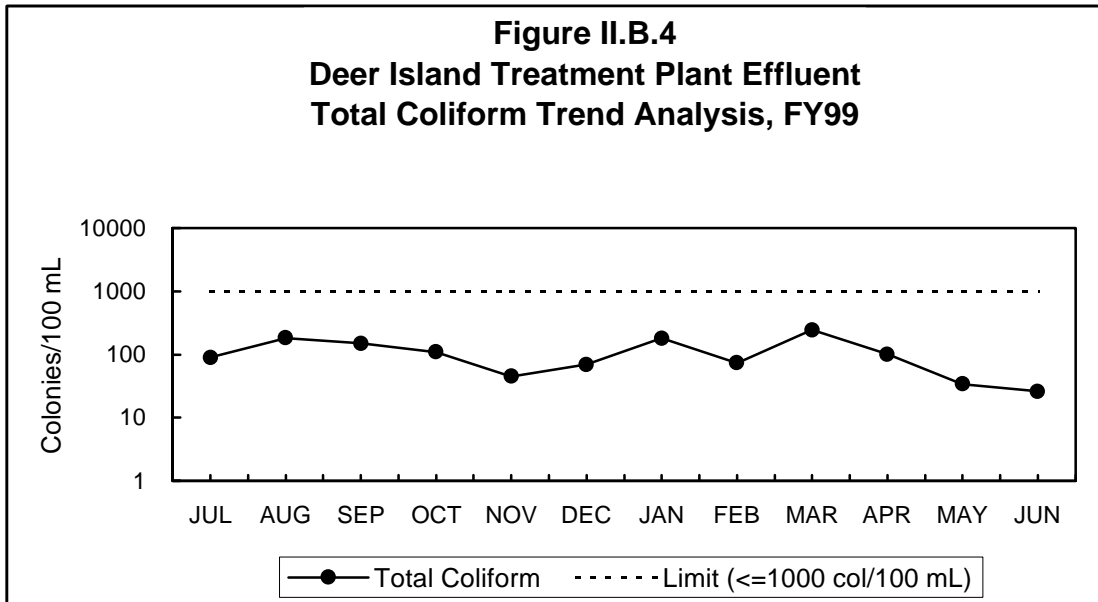

The limits for pH are based on the maximum and minimum values for each month, with pH required to fall between 6.5 and 8.5. In FY99, the pH of the effluent was always below the maximum of 8.5, but fell below the minimum value on 70 days. As explained in Table II.B.1, the pure oxygen secondary treatment system caused this drop in pH. Excess carbon dioxide dissolves into the effluent and lowers the pH. The new NPDES permit makes allowances for the expected lower pH by expanding the limits to 6.0-9.0. The artificially lowered pH has no measurable impact on the quality of the receiving waters because of the buffering capacity of the receiving water.

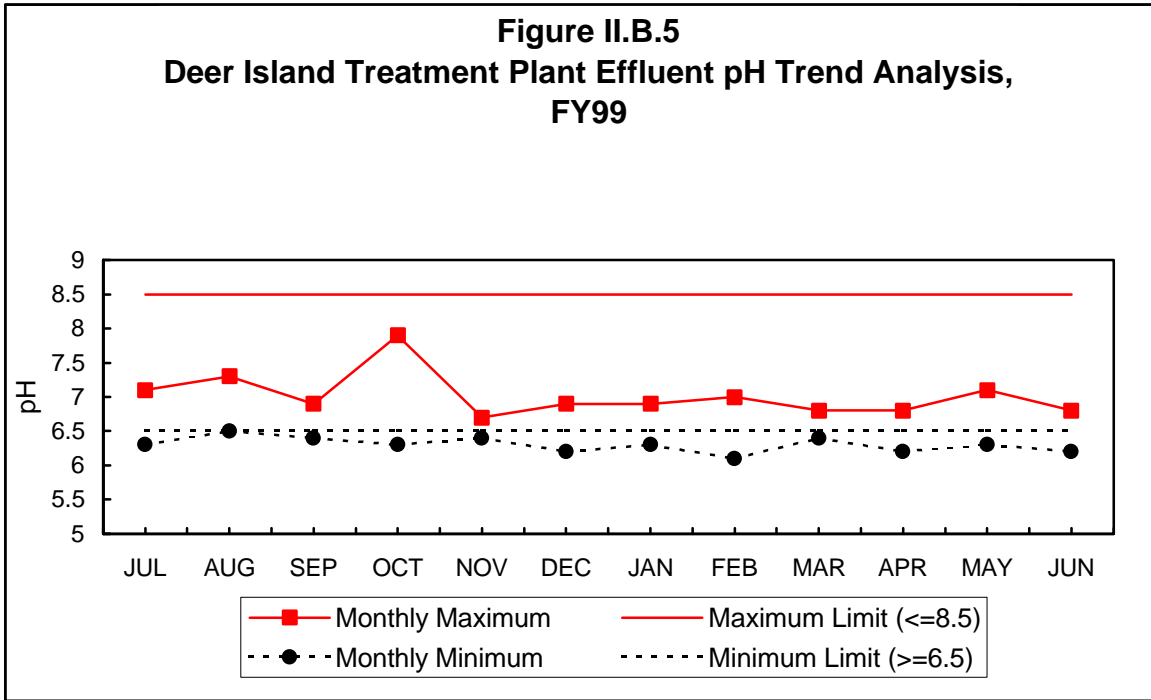

Deer Island Treatment Plant effluent concentrations were well below the maximum limit for settleable solids (2.8 mL/L), as Figure II.B.6 illustrates.

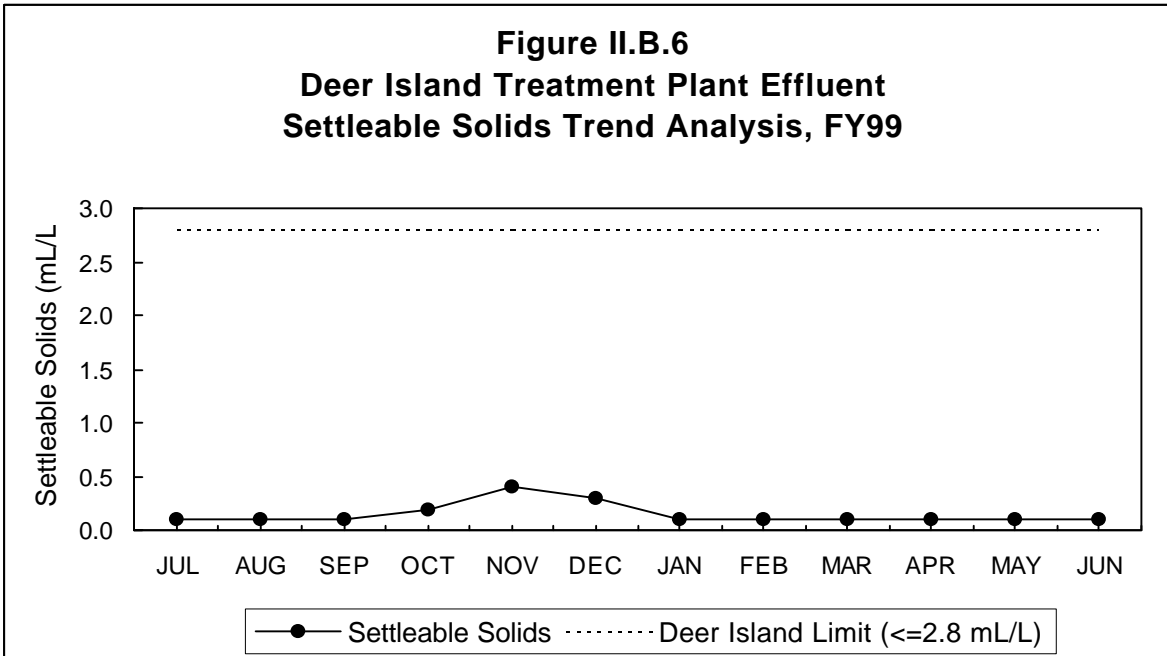

II.B.2 Effluent Quality Compared to Water Quality Standards

Concentrations of priority pollutants in Deer Island Treatment Plant effluent were compared to water quality criteria in Table II.B.3. The majority of priority pollutant parameters were below detection levels. Those that were detected had relatively low concentrations.

Given a theoretical minimum dilution of 10:1 (and an average dilution of 20:1 to 25:1), the priority pollutants that were detected would not violate EPA's water quality criteria, as Table II.B.3 shows.

Parameter	Total Recoverable	Total Dissolved	Total Recoverable	Total Dissolved	Times Detected	Acute	Total Dissolved	Chronic	Total Dissolved
	Max. Conc. (ug/L)	Max. Conc. * (ug/L)	Avg. Conc. (ug/L)	Avg. Conc. * (ug/L)		Criteria ** (ug/L)	Max. Conc.: Acute Criteria	Criteria ** (ug/L)	Avg. Conc.: Chronic Criteria
Arsenic	2.12	2.12	0.66	0.66	24 out of 78	69.0	A	36.0	A
Copper	33.30	27.64	18.29	15.18	66 out of 77	4.8	7:1	3.1	5:1
Lead	16.80	15.98	2.91	2.76	21 out of 77	210.0	A	8.1	A
Mercury	0.17	0.14	0.05	0.04	63 out of 77	1.8	A	0.94	A
Nickel	17.30	17.13	3.88	3.84	30 out of 77	74.0	A	8.2	A
Silver	3.74	3.18	1.33	C	27 out of 77	1.9	2:1	B	B
Zinc	96.00	90.82	35.15	33.25	72 out of 75	90.0	1:1	81.0	A

A - Ratio lower than 1:1
 B - No applicable criteria
 C - No applicable conversion factor
 * Calculated using the conversion factors in Appendix A of the Federal Register, December 10, 1998
 ** National Recommended Water Quality Criteria for Priority Toxic Pollutants, Federal Register, December 10, 1998

III Combined Sewer Overflow Facilities

MWRA monitors six Combined Sewer Overflow (CSO) facilities in the North System. The monitoring results vary significantly between facilities because of differences in the type and location of the facilities.

At each of the CSO facilities, the combined wastewater (sewage and storm water) is chlorinated prior to discharge. Of the six CSO facilities, only the Cottage Farm and Prison Point facilities have pumping and tank storage capacity. This allows for chlorinated wastewater to be held at these facilities up to their storage capacities, prior to discharge. Any wastewater exceeding the storage capacity will overflow and is discharged to the river. The four other CSO facilities – Somerville Marginal, Constitution Beach, Fox Point and Commercial Point – are gravity CSO facilities, which means that combined wastewater arrives and leaves the CSO facility by gravity instead of by pumping. The combined wastewater is disinfected and the chlorinated wastewater overflows to the receiving water as quickly as it arrives at the facility. A detailed description of the six CSO facilities can be found in Appendix I.

III.A Cottage Farm Combined Sewer Overflow Facility

III.A.1 Activations

Table III.A.1 and Figures III.A.1 and III.A.2 summarize activation data for the Cottage Farm CSO facility. There was a significant decrease in total volume treated from FY98 to FY99. The volume treated in FY99 was less than a third of that treated the previous year. The total rainfall and the number of activations also decreased measurably in FY99. The reduction in volume might also be attributed to increased pumping capacity at Deer Island, since the Cottage Farm CSO facility is hydraulically linked to Deer Island.

Almost 40% of the total treated volume was treated in the month of January and more than 60% of the total volume was treated in October and January.

Table III.A.1 Cottage Farm CSO Activations Summary

	FY92	FY93	FY94	FY95	FY96	FY97	FY98	FY99
Number of Activations	23	33	31	25	26	24	19	11
Number of Days Activated	23	33	31	25	33	29	22	13
Total Volume Treated (MG)	361	677	621	574	918	1092	792	259
Maximum Flow (mgd)	64	145	123	100	94	199	114	47
Minimum Flow (mgd)	0.01	0.69	0.08	0.09	1.88	0.63	0.76	1.35
Average Flow (mgd)	15.70	20.52	20.03	22.96	27.83	37.66	36.01	19.92
Total Rainfall (in/year)	41.18	48.82	45.00	37.40	42.55	48.79	50.87	32.41

Average flow is calculated by dividing the total volume treated by the number of days activated

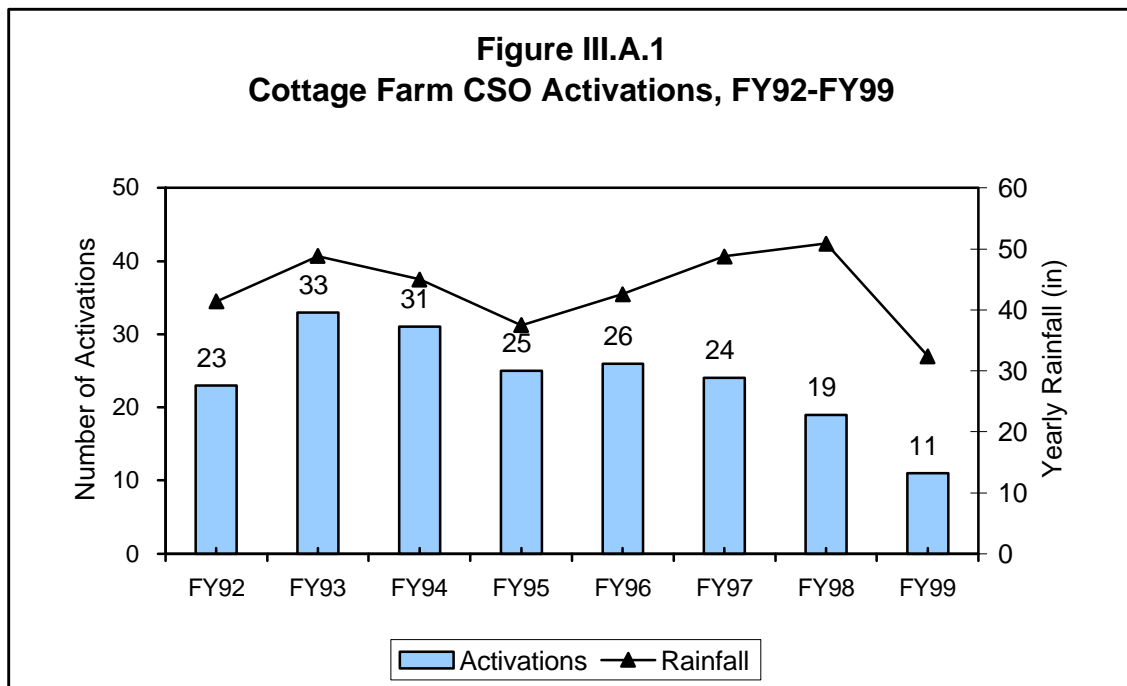

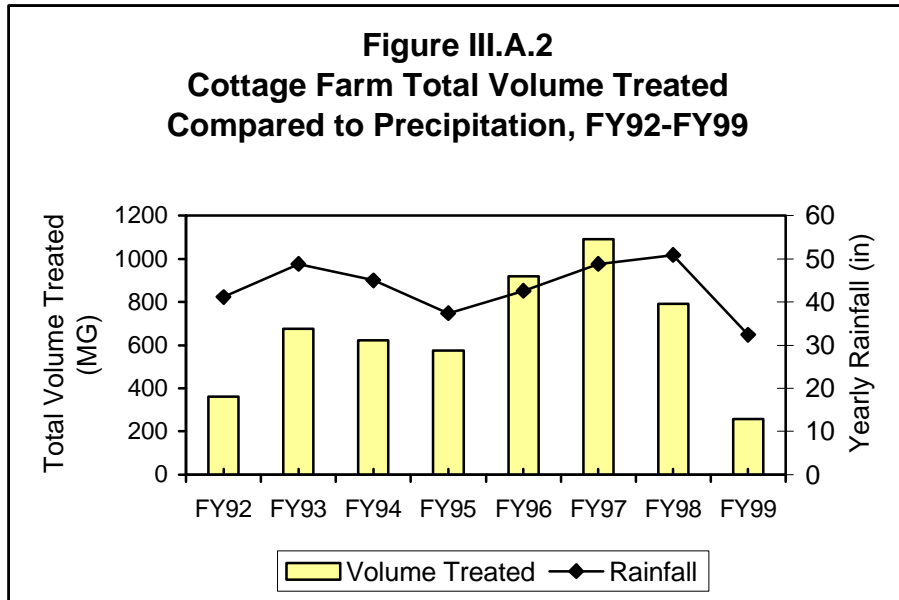
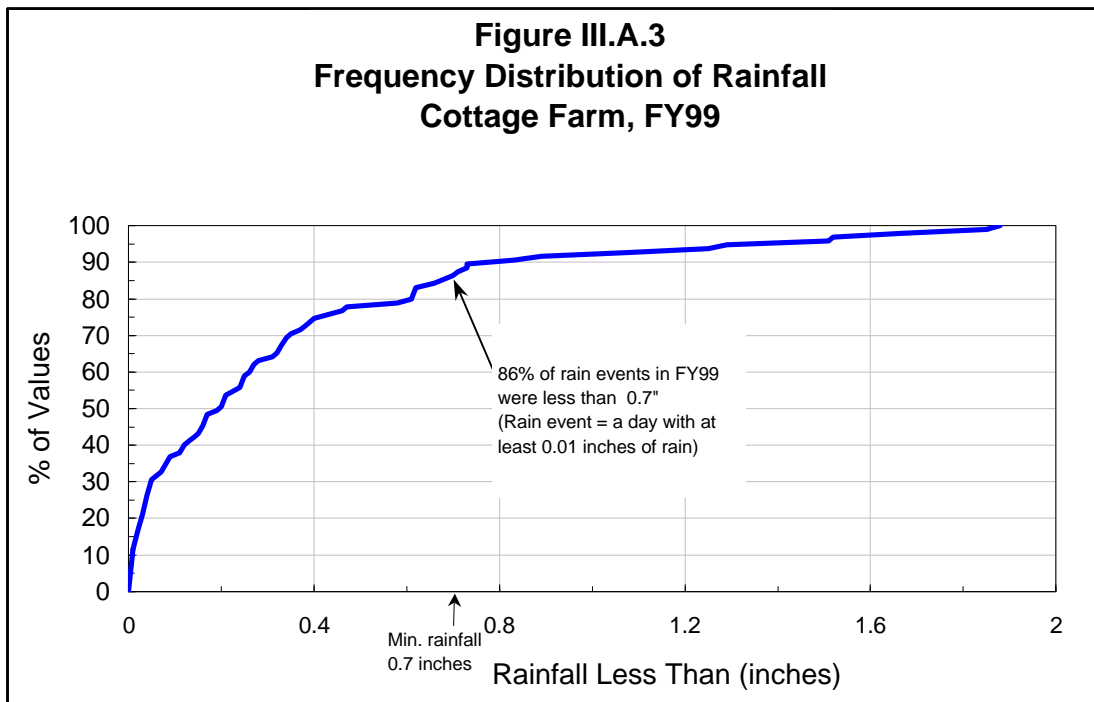

Figure III.A.3 shows the frequency distribution of rainfall in FY99, and highlights the minimum amount of rainfall (0.7 inches of rain) at which the Cottage Farm facility activated in FY99. The frequency distribution considers all rain events, which are defined as days with at least 0.01 inches of rainfall. According to the frequency distribution, activation of the Cottage Farm facility occurred during 14% of FY99 rain events.



III.A.2 Conventional Parameters

Tables B-1 and B-2 of Appendix B contain data on conventional parameters in Cottage Farm influent and effluent. Table III.A.2 summarizes this data. There were times when the BOD and TSS loadings of the effluent measured higher than those of the influent. This is because the Cottage Farm facility is not designed to remove such contaminants, and also because of the variable characteristics of combined sewage.

**Table III.A.2
Cottage Farm CSO Influent and Effluent Characteristics, FY99**

Parameter	Concentration (1)					
	Influent			Effluent		
	Min	Avg	Max	Min	Avg	Max
TSS	42	146	278	44	88	159
BOD	55	108	222	26	74	121
Fecal Coliform (col/100 mL)				<10	11	40
pH (units)				6.9		7.0

(1) Concentration expressed in mg/L except for pH and fecal coliform.

III.A.3 Priority Pollutants

Cottage Farm effluent was tested for priority pollutants for at least one activation per month. The results of these tests are presented in Appendix B Tables B-3 and B-4. Metals were the most commonly detected priority pollutant, with copper, mercury, lead and zinc detected in all samples. Several other priority pollutants were detected in some samples.

Table III.A.3 summarizes average metals concentrations in Cottage Farm effluent in FY99.

Table III.A.3 Cottage Farm Metals, FY99

	Average Concentration (ug/L)	Times Detected
Cadmium	1.28	1 of 4
Copper	51.85	4 of 4
Mercury	0.18	4 of 4
Nickel	4.87	2 of 4
Lead	48.98	4 of 4
Zinc	104.93	4 of 4

III.B Prison Point Combined Sewer Overflow Facility

III.B.1 Activations

Activation data for the Prison Point CSO facility are summarized in Table III.B.1 and Figures III.B.1 and III.B.2.

Unlike the Cottage Farm CSO facility, the Prison Point facility is not hydraulically connected to the Deer Island Treatment Plant, so increased pumping at Deer Island will not affect Prison Point activation. In addition, the Prison Point facility will activate during smaller rain events than the Cottage Farm facility (compare Figure III.A.3 with Figure III.B.3).

The volume treated at Prison Point in FY99 was about 39% of the volume treated in FY98. There was also a significant decrease in the total rainfall from FY98 to FY99 and a fewer number of activations. The volume treated during FY98 and FY97 was significantly higher than in any of the previous years, even during years of comparable rainfall. This increase can be attributed to the high-intensity storms that occurred during those years.

Table III.B.1 Prison Point CSO Activations Summary

	FY92	FY93	FY94	FY95	FY96	FY97	FY98	FY99
Number of Activations	29	26	26	26	24	26	32	23
Number of Days Activated	29	26	26	26	29	30	34	23
Total Volume Treated (MG)	429	269	449	460	445	926	958	396
Maximum Flow (mgd)	63	28	80	127	63	228	143	51
Minimum Flow (mgd)	1.08	1.63	3.01	1.63	1.24	1.50	2.00	1.4
Average Flow (mgd)	14.79	10.34	17.27	17.69	15.34	30.86	28.18	17.22
Total Rainfall (in/year)	41.18	48.82	45.00	37.40	42.55	48.79	50.87	32.41

Average flow is calculated by dividing the total volume treated by the number of days activated.

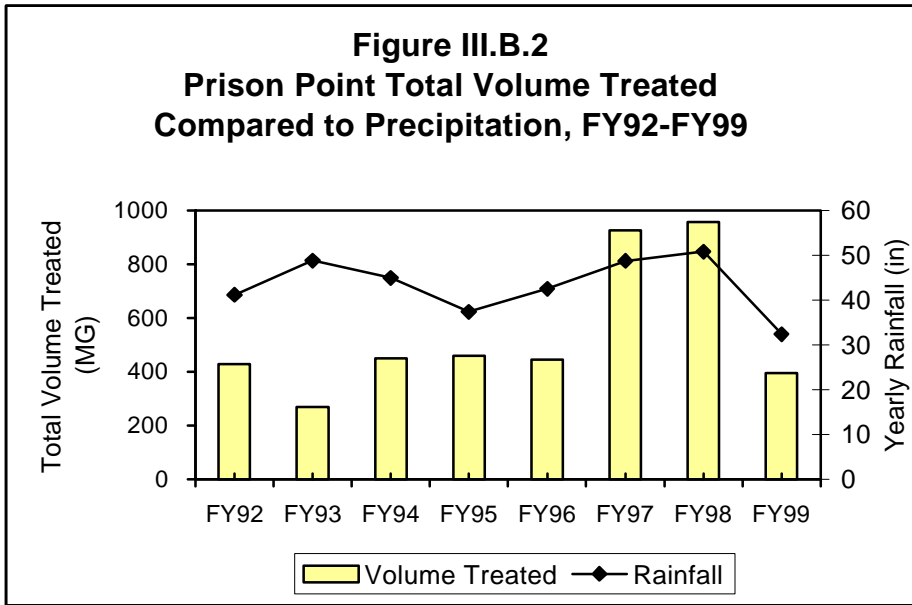
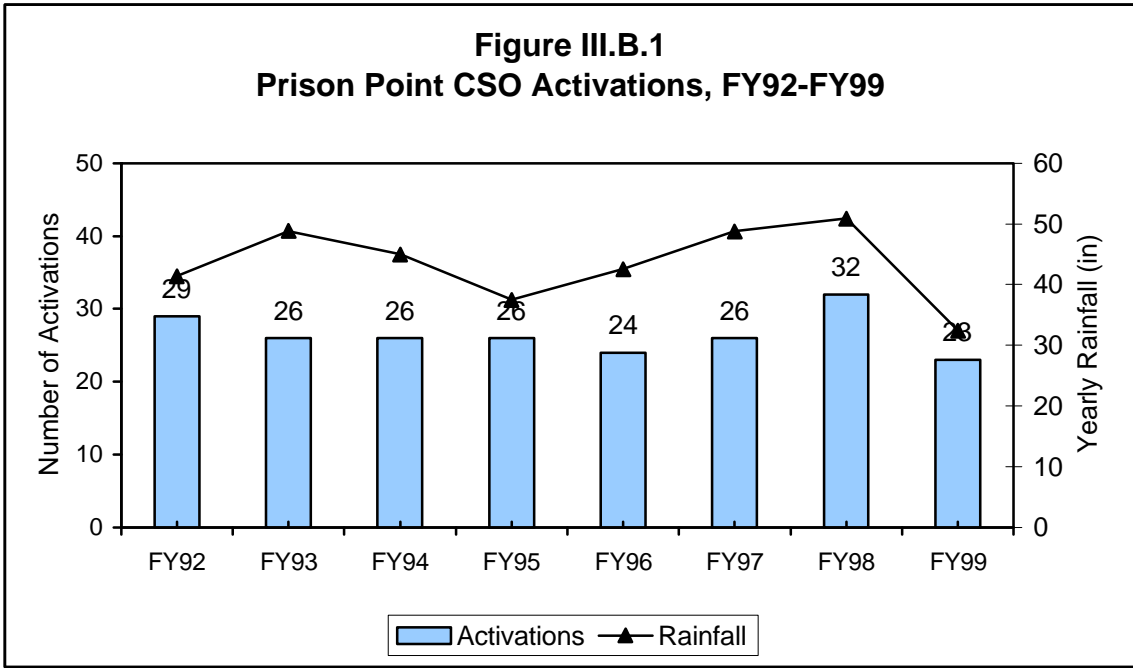
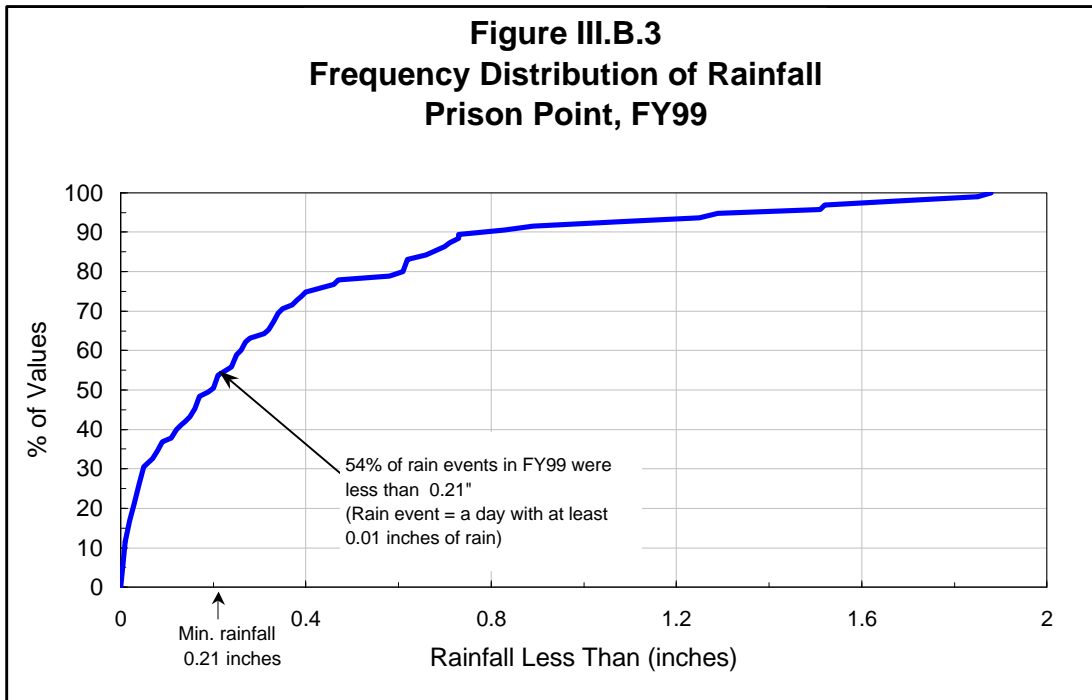

Figure III.B.3 shows the frequency distribution of rainfall in FY99, and highlights the minimum amount of rainfall (0.21 inches of rain) at which the Prison Point facility activated. According to the frequency distribution, activation of the Prison Point facility occurred during 46% of FY99 rain events.



III.B.2 Conventional Parameters

Conventional parameter data for Prison Point influent and effluent are provided in Appendix C Tables C-1 and C-2. Like the Cottage Farm facility, Prison Point is not designed to remove some contaminants.

There were no NPDES permit violations at Prison Point in FY99.

**Table III.B.2
Prison Point CSO Influent and Effluent Characteristics, FY99**

Parameter	Concentration (1)					
	Influent			Effluent		
	Min	Avg	Max	Min	Avg	Max
TSS	17	310	1080	44	146.2	360
BOD	13	98	299	21	62.23	184
Fecal Coliform (col/100 mL)				<10	18.86	170
pH (units)				6.8		7.4

(1) Concentration expressed in mg/L except for pH and fecal coliform.

III.B.3 Priority Pollutants

The results of priority pollutant testing for Prison Point can be found in Tables C-3 and C-4 of Appendix C. As with Cottage Farm, metals were the most commonly detected priority pollutants, with copper, mercury, lead and zinc detected in all samples. Other priority pollutants were detected in some but not all samples.

Table III.B.3 summarizes average metals concentrations in Prison Point effluent in FY99.

	Average Concentration (ug/L)	Times Detected
Cadmium	1.16	1 of 9
Copper	87.26	9 of 9
Mercury	0.42	9 of 9
Nickel	9.35	7 of 9
Lead	136.16	9 of 9
Zinc	224.69	9 of 9

III.C Somerville Marginal Combined Sewer Overflow Facility

III.C.1 Activations

Table III.C.1 and Figures III.C.1 and III.C.2 summarize activation information for the Somerville Marginal facility.

Recently, there has been increased attention to SSOs (sanitary sewer overflows). MWRA intensified its monitoring efforts at areas known to overflow when there is a measurable rainfall event. (See Section IV for more information about SSOs.) As a result, MWRA has inspected its CSO facilities more frequently, even during lower intensity rainfall. In particular, the gravity CSO facilities, Somerville Marginal, Constitution Beach, Fox Point and Commercial Point, have been monitored more frequently. This improved monitoring of CSO facilities has captured short activations during low intensity rainfall. In previous years, these activations may not have been recorded.

Table III.C.1 Somerville Marginal CSO Activations Summary

	FY92	FY93	FY94	FY95	FY96	FY97	FY98	FY99
Number of Activations	48	45	34	28	28	28	30	19
Number of Days Activated	48	45	34	28	30	29	31	19
Total Volume Treated (MG)	89	90	72	49	80	142	128	57.32
Maximum Flow (mgd)	9	8	11	14	9	64	22	10.29
Minimum Flow (mgd)	0.003	0.10	0.01	0.16	0.25	0.13	0.09	0.04
Average Flow (mgd)	1.85	2.00	2.12	1.75	2.67	4.90	4.12	3.02
Total Rainfall (in/year)	41.18	48.82	45.00	37.40	42.55	48.79	50.87	32.41

Average flow is calculated by dividing the total volume treated by the number of days activated.

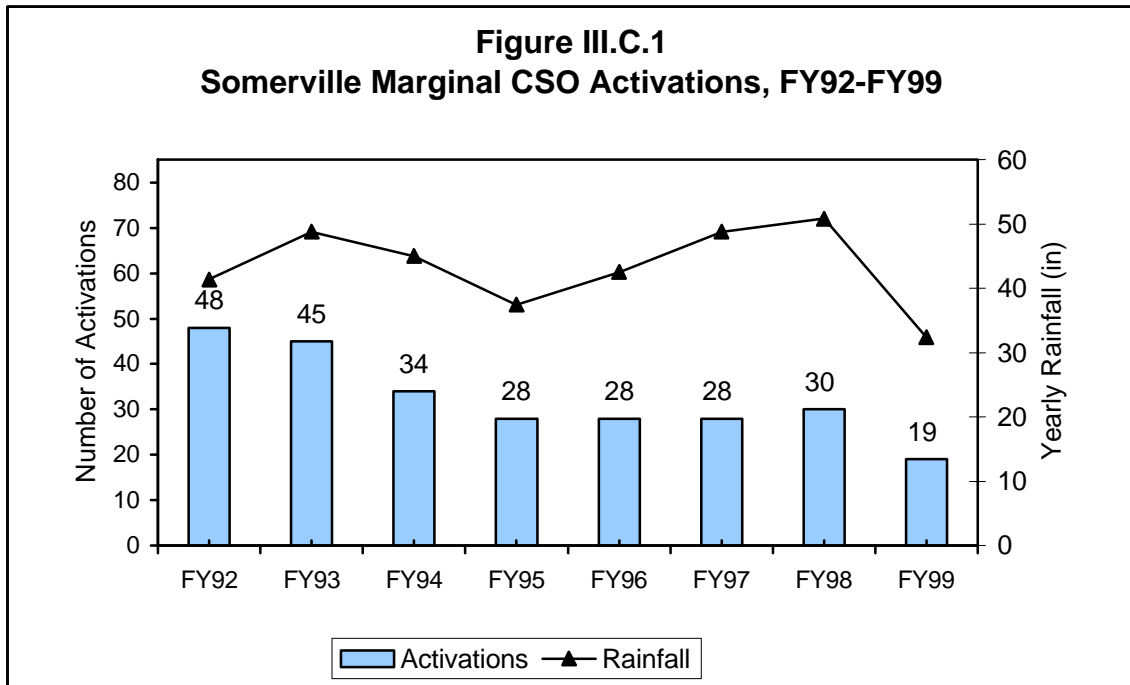

Figure III.C.2 shows the volume treated at the Somerville Marginal gravity CSO facility over the past eleven years. Somerville Marginal flow measurements in previous years were estimated low because the measurements did not include flows when the flow meters were malfunctioning. The Somerville Marginal facility responds to rainfall almost immediately, so that increased rainfall intensity will always result in an activation and consequently in increased volume treated.

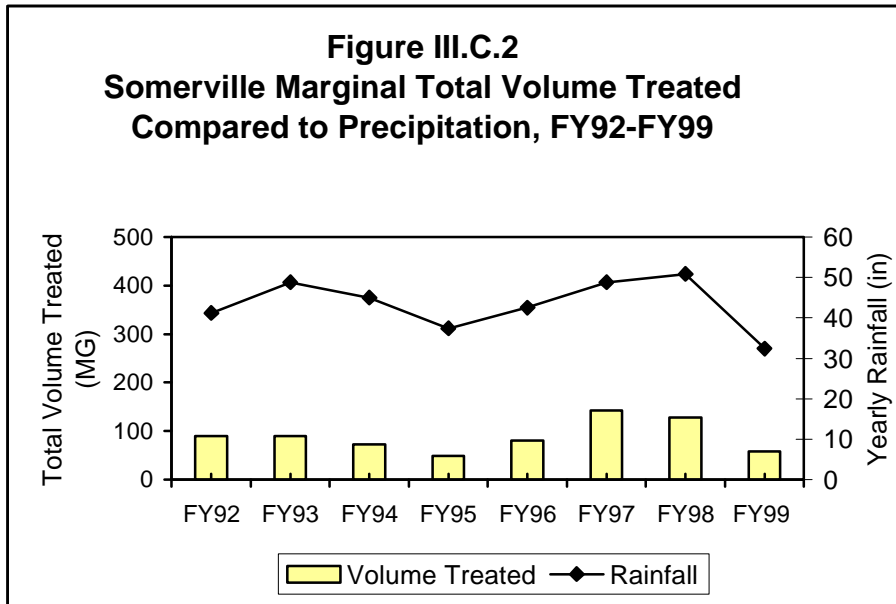
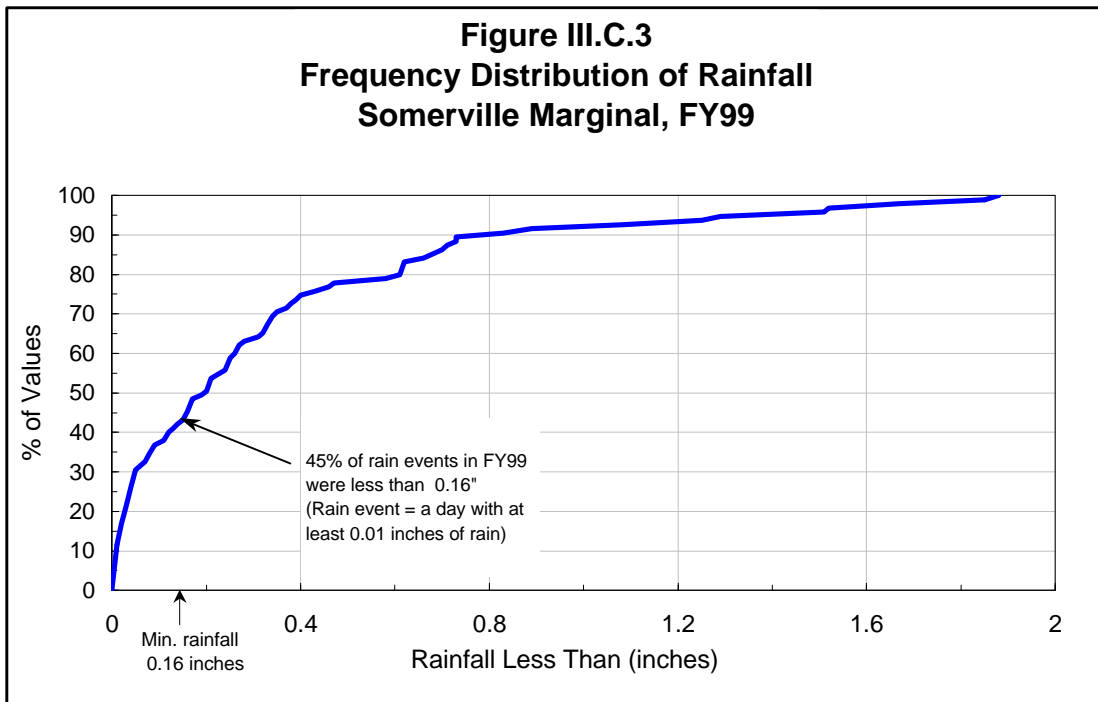

Figure III.C.3 shows the frequency distribution of rainfall in FY99 and highlights the minimum rainfall event (0.16 inches of rain) at which the Somerville Marginal facility activated. According to the frequency distribution, activation of the Somerville Marginal facility occurred during 55% of FY99 rain events.



III.C.2 Conventional Parameters

Somerville Marginal conventional parameter data are provided in Tables D-1 and D-2 of Appendix D, and are summarized in Table III.C.2. The Somerville Marginal treatment facility, like Cottage Farm and Prison Point, is not designed to remove some contaminants.

There were no violations of the NPDES permit at Somerville Marginal in FY99.

Parameter	Concentration (1)					
	Influent			Effluent		
	Min	Avg	Max	Min	Avg	Max
TSS	32	112	267	52	150.9	318
BOD	10	38	121	7	33.45	62
Fecal Coliform (col/100 mL)				< 10	16.34	60
pH (units)				6.6		7.3

(1) Concentration expressed in mg/L except for pH and fecal coliform.

III.C.3 Priority Pollutants

The results of Somerville Marginal priority pollutant testing can be found in Appendix D Tables D-3 and D-4. Copper, mercury, lead, zinc and surfactants were detected in all samples, while several other priority pollutants were detected in some but not all samples.

Table III.C.3 summarizes average metals concentrations in Somerville Marginal effluent in FY99.

Table III.C.3 Somerville Marginal Metals, FY99

	Average Concentration (ug/L)	Times Detected
Copper	87.26	9 of 9
Mercury	0.42	9 of 9
Nickel	9.35	7 of 9
Lead	136.16	9 of 9
Zinc	224.69	9 of 9

III.D Constitution Beach Combined Sewer Overflow Facility

III.D.1 Activations

Activation data for the Constitution Beach facility are summarized in Table III.D.1 and Figures III.D.1 and III.D.2.

The particularly low flows passing through the Constitution Beach facility in FY93-FY94 resulted from meter malfunctions. The amount of flow and the number of activations increased from FY94 to FY97. This increase was caused by increasing rainfall intensity and by changes to in-line storage practices. In FY98, there was a slight decrease in the flow, but the number of activations continued to increase. For FY99, there was a considerable decrease in rainfall and in the number of activations, corresponding to a major reduction in the flow.

Some flow data for Constitution Beach may be inaccurate because the flow meters are affected by tidal flow. However, since FY95, trends show that the volume treated corresponds with rainfall intensity.

As mentioned above, improved monitoring at the CSO facilities meant that shorter activations were recorded. In FY99, of the 15 activations reported for the Constitution Beach facility, eleven of them contributed less than 0.15 MG to the total volume treated.

Table III.D.1 Constitution Beach CSO Activations Summary

	FY92	FY93	FY94	FY95	FY96	FY97	FY98	FY99
Number of Activations	12	4	8	12	13	16	20	15
Number of Days Activated	12	4	8	12	13	17	21	15
Total Volume Treated (MG)	10.94	1.57	0.69	6.80	7.94	11.32	10.52	1.76
Maximum Flow (mgd)	1.94	1.22	0.20	1.30	1.20	2.35	3.24	0.36
Minimum Flow (mgd)	0.23	0.10	0.01	0.20	0.21	0.14	0.06	0.02
Average Flow (mgd)	0.91	0.39	0.09	0.57	0.61	0.67	0.50	0.12
Total Rainfall (in/year)	41.18	48.82	45.00	37.40	42.55	48.79	50.87	32.41

Average flow is calculated by dividing the total volume treated by the number of days activated.

**Figure III.D.1
Constitution Beach CSO Activations, FY92-FY99**

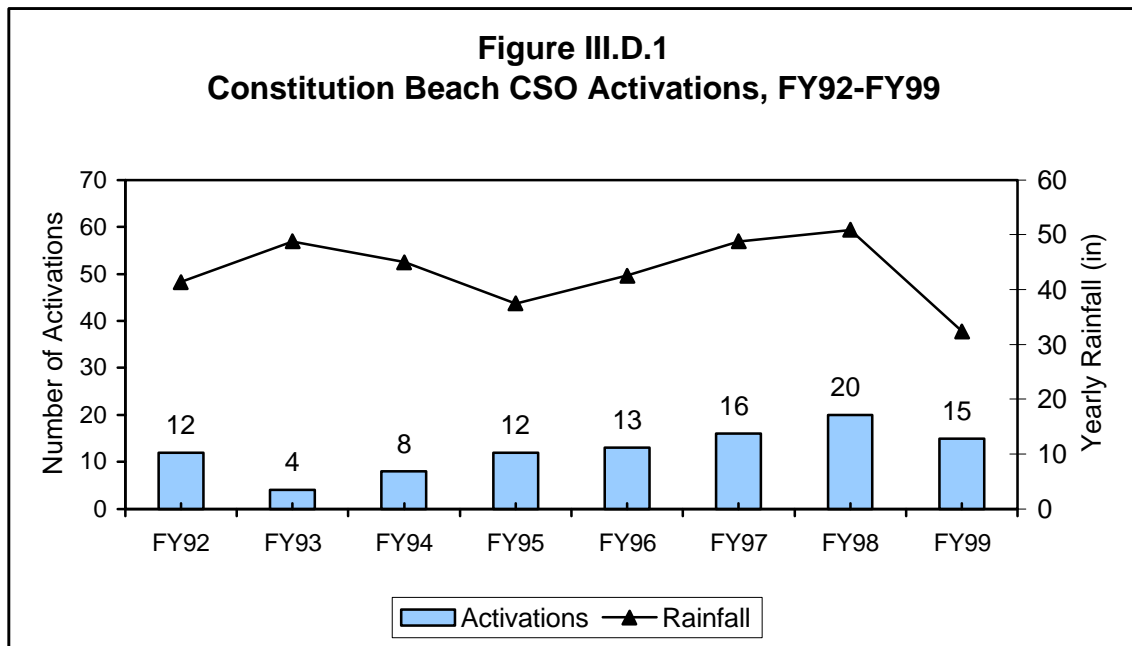

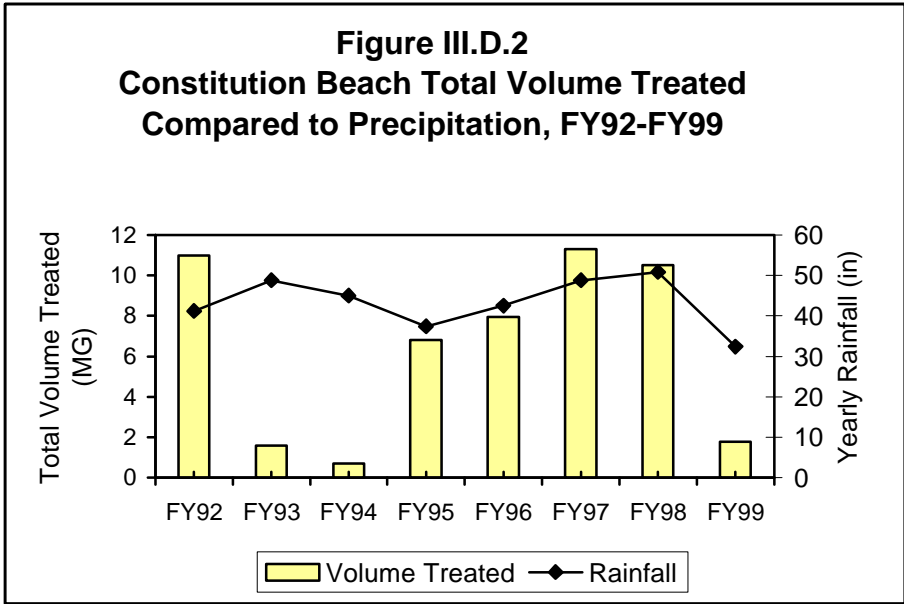
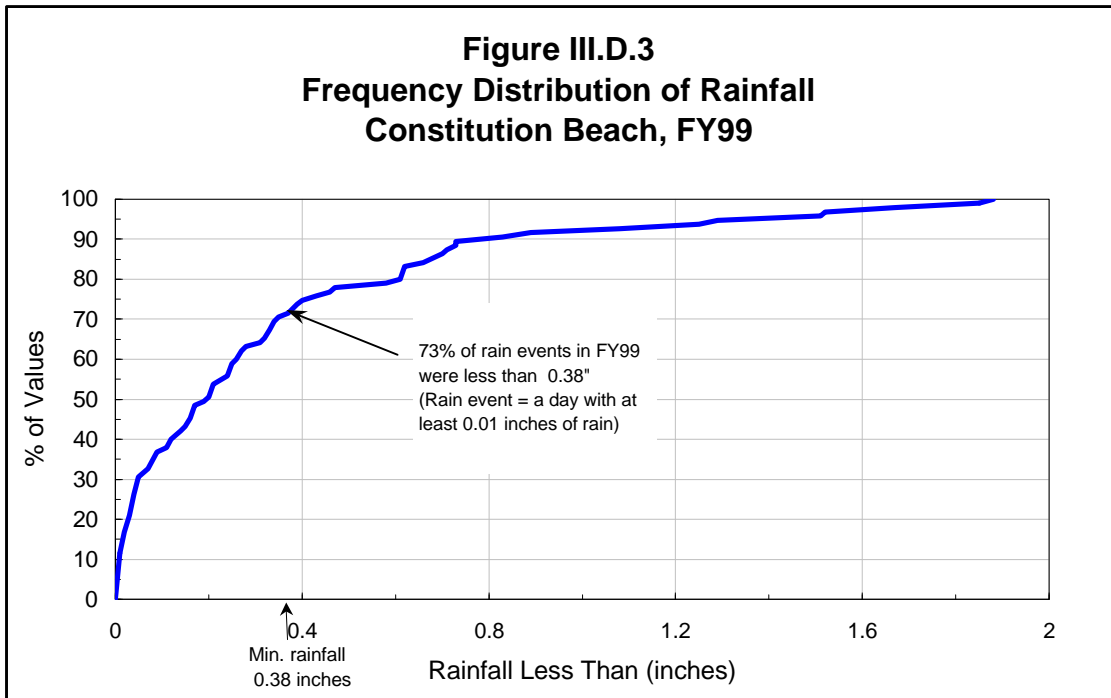

Figure III.D.3 shows the frequency distribution of rainfall in FY99, and highlights the minimum point (0.38 inches of rain) at which the Constitution Beach facility activated. According to the frequency distribution, activation of the Constitution Beach facility occurred during 27% of FY99 rain events.



III.D.2 Conventional Parameters

Conventional parameter data for the Constitution Beach facility are provided in Appendix E Tables E-1 and E-2 and summarized in Table III.D.2. As with the other CSO facilities, concentrations fluctuated a good deal in both influent and effluent.

Table III.D.2
Constitution Beach CSO Influent and Effluent Characteristics, FY99

Parameter	Concentration (1)					
	Influent			Effluent		
	Min	Avg	Max	Min	Avg	Max
TSS	34	56.5	79	52	67	82
BOD	<16.4	38	59	8	43	79
Fecal Coliform (col/100 mL)				<10	10	<10
pH (units)				7.5		7.6

(1) Concentration expressed in mg/L except for pH and fecal coliform.

III.E Fox Point Combined Sewer Overflow Facility

III.E.1 Activations

Activation data for Fox Point are summarized in Table III.E.1 and Figures III.E.1 and III.E.2.

The volume treated at Fox Point has been increasing from FY93 to FY98, with the exception of FY95, when use of the facility was decreased due to repair work that required rerouting of flows. In FY99, the flow was approximately 36% of that in FY98. This reduction was due to a major decrease in the number of activations as well as a drop in the total rainfall.

Table III.E.1 Fox Point CSO Activations Summary

	FY92	FY93	FY94	FY95	FY96	FY97	FY98	FY99
Number of Activations	22	21	20	4	12	16	21	12
Number of Days Activated	22	21	20	4	14	18	24	12
Total Volume Treated (MG)	38	37	76	24	97	154	166	59.3
Maximum Flow (mgd)	5	8	12	10	17	45	39	14.8
Minimum Flow (mgd)	0.40	0.36	0.40	1.50	1.09	0.26	0.17	0.31
Average Flow (mgd)	1.73	1.76	3.80	6.00	6.90	8.55	6.92	4.94
Total Rainfall (in/year)	41.18	48.82	45.00	37.40	42.55	48.79	50.87	32.41

Average flow is calculated by dividing the total volume treated by the number of days activated.

**Figure III.E.1
Fox Point CSO Activations, FY92-FY99**

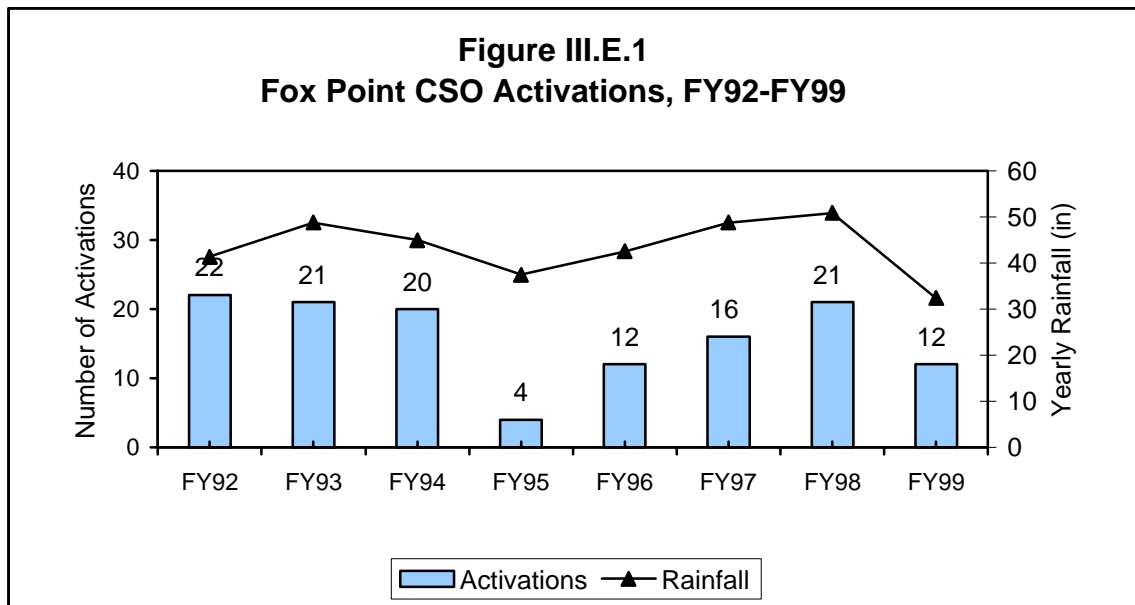

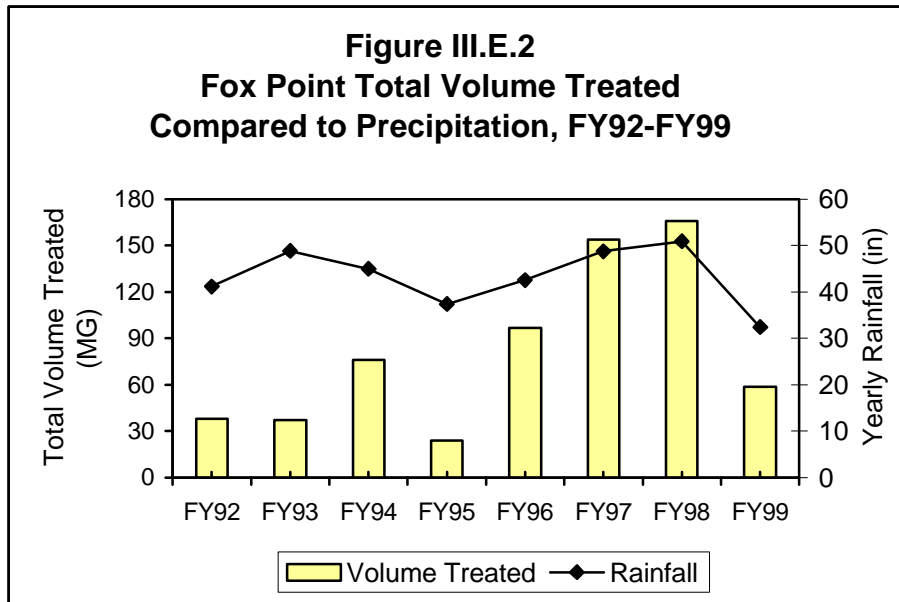
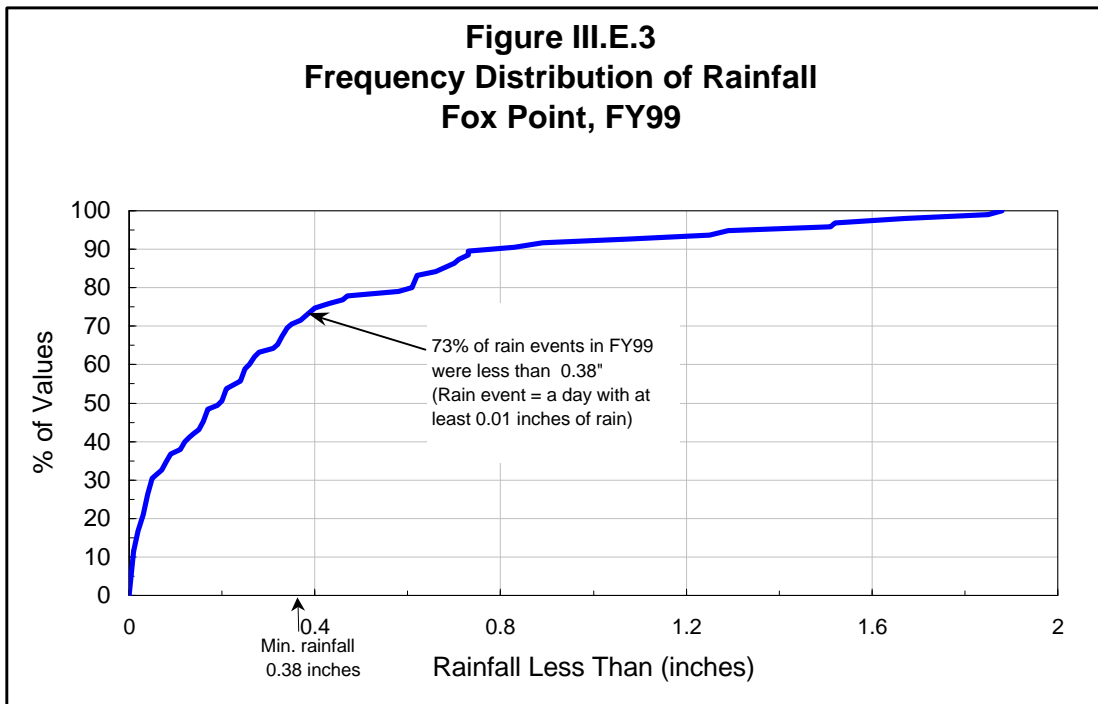

Figure III.E.3 shows the frequency distribution of rainfall in FY99 and highlights the minimum rainfall event (0.38 inches of rain) at which the Fox Point facility activated. According to the frequency distribution, activation of the Fox Point facility occurred during 27% of FY99 rain events.



III.E.2 Conventional Parameters

Conventional parameter data for the Fox Point CSO facility are provided in Appendix F Tables F-1 and F-2 and are summarized in Table III.E.2. Again, a wide range of values was reported for both influent and effluent.

Parameter	Concentration (1)					
	Influent			Effluent		
	Min	Avg	Max	Min	Avg	Max
TSS	42	561	2900	66	102.7	142
BOD	21	62	188	15	46.68	80.1
Fecal Coliform (col/100 mL)				<10	13.48	60
pH (units)				6.8		7.8

(1) Concentration expressed in mg/L except for pH and fecal coliform.

III.F Commercial Point Combined Sewer Overflow Facility

III.F.1 Activations

Commercial Point activation data are summarized in Table III.F.1 and Figures III.F.1 and III.F.2.

A decrease in total rainfall and number of activations resulted in the FY99 flow being half of the FY98 flow.

Table III.F.1 Commercial Point CSO Activations Summary

	FY92	FY93	FY94	FY95	FY96	FY97	FY98	FY99
Number of Activations	33	28	25	19	13	23	25	20
Number of Days Activated	33	28	25	19	14	24	28	20
Total Volume Treated (MG)	80	77	93	56	70	158	125	62.78
Maximum Flow (mgd)	11	10	17	17	18	54	25	12.39
Minimum Flow (mgd)	1.00	0.10	0.21	0.15	0.06	0.19	0.14	0.1
Average Flow (mgd)	2.42	2.76	3.72	2.94	5.01	6.59	4.46	3.14
Total Rainfall (in/year)	41.18	48.82	45.00	37.47	42.55	48.79	50.87	32.41

Average flow is calculated by dividing the total volume treated by the number of days activated.

**Figure III.F.1
Commercial Point CSO Activations, FY92-FY99**

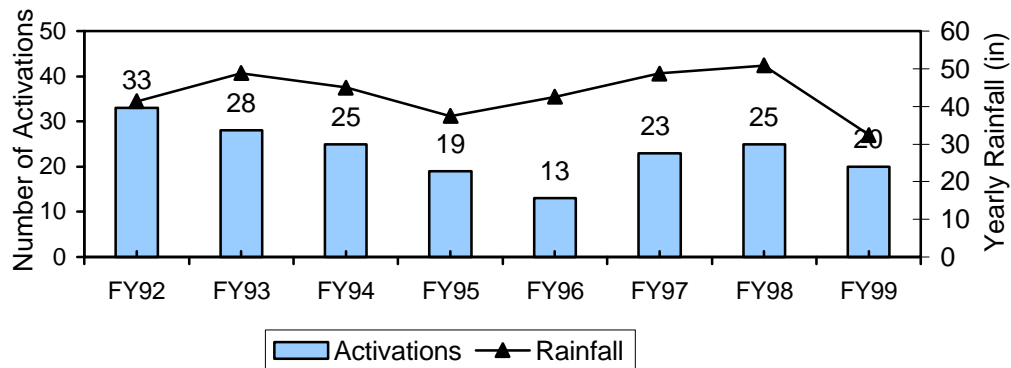

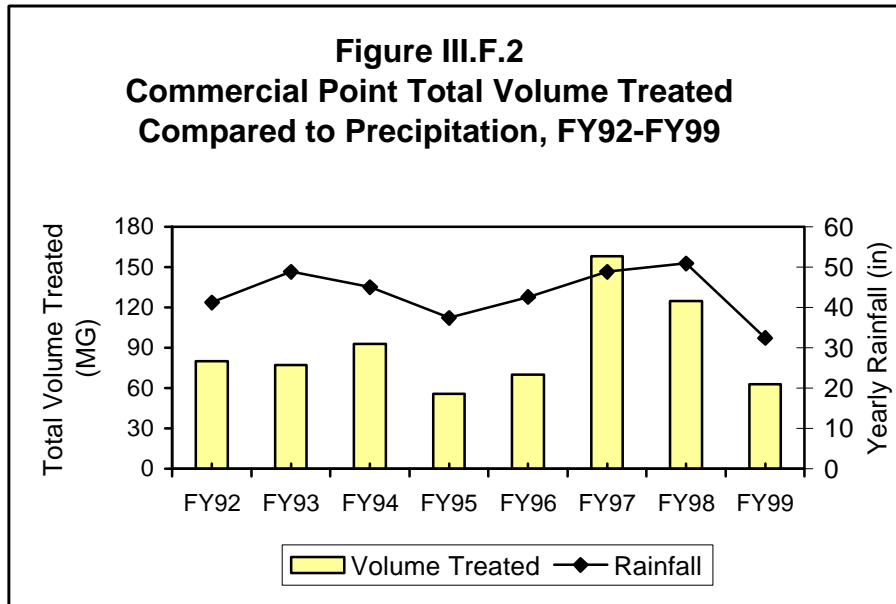
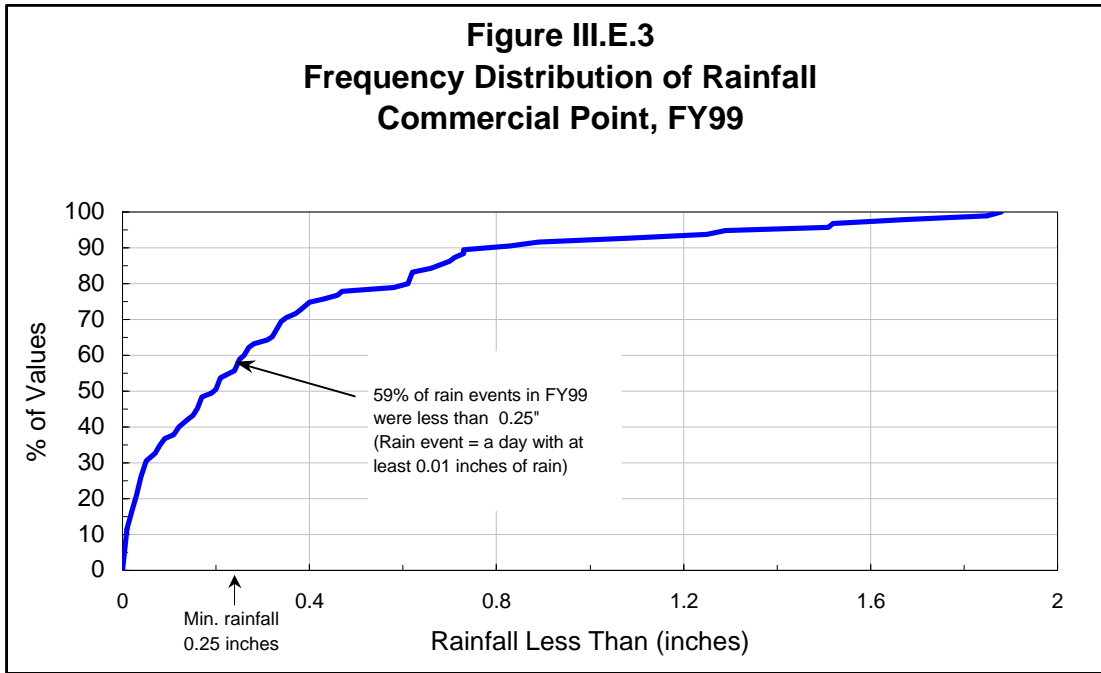

Figure III.F.3 shows the frequency distribution of rainfall in FY99 and highlights the minimum rainfall event (0.25 inches of rain) at which the Commercial Point facility activated. According to the frequency distribution, activation of the Commercial Point facility occurred during 41% of FY99 rain events.



III.F.2 Conventional Parameters

Commercial Point conventional parameter data are provided in Appendix G Tables G-1 and G-2. Again, a wide range of values was reported for both influent and effluent.

Table III.F.2
Commercial Point CSO Influent and Effluent Characteristics, FY99

Parameter	Concentration (1)					
	Influent			Effluent		
	Min	Avg	Max	Min	Avg	Max
TSS	21	485	2290	18	120.7	354
BOD	11	28	46	7	41.21	97.2
Fecal Coliform (col/100 mL)				<10	30	120
pH (units)				7.0		8.4

(1) Concentration expressed in mg/L except for pH and fecal coliform.

IV Transport Systems

IV.A North System

IV.A.1 Headworks Choking

Figure IV.A.1 shows the number of hours of maintenance-related choking and rain-related choking at the remote headworks over the last eight years.

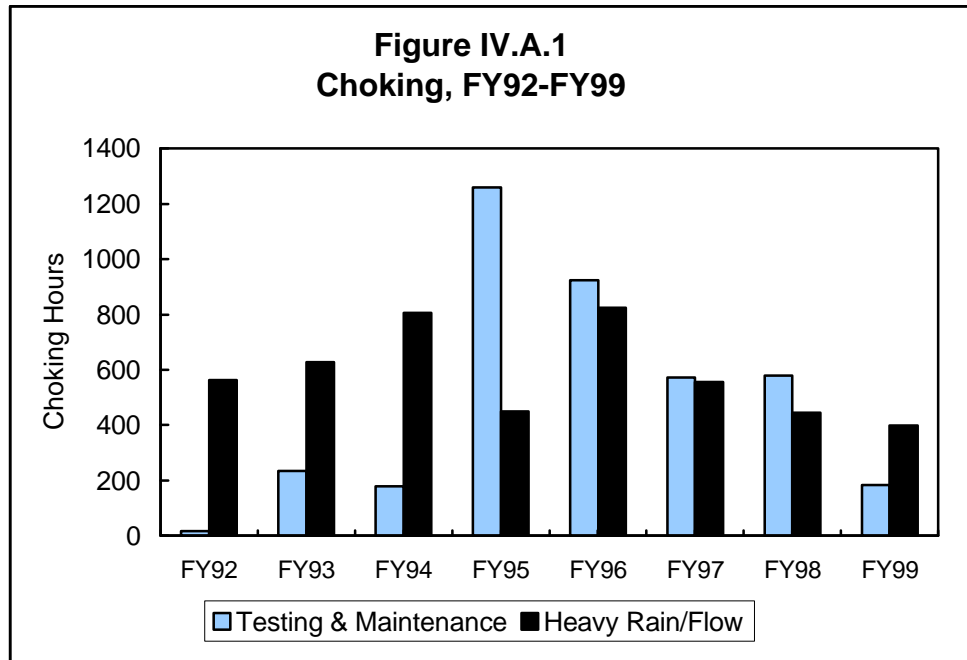
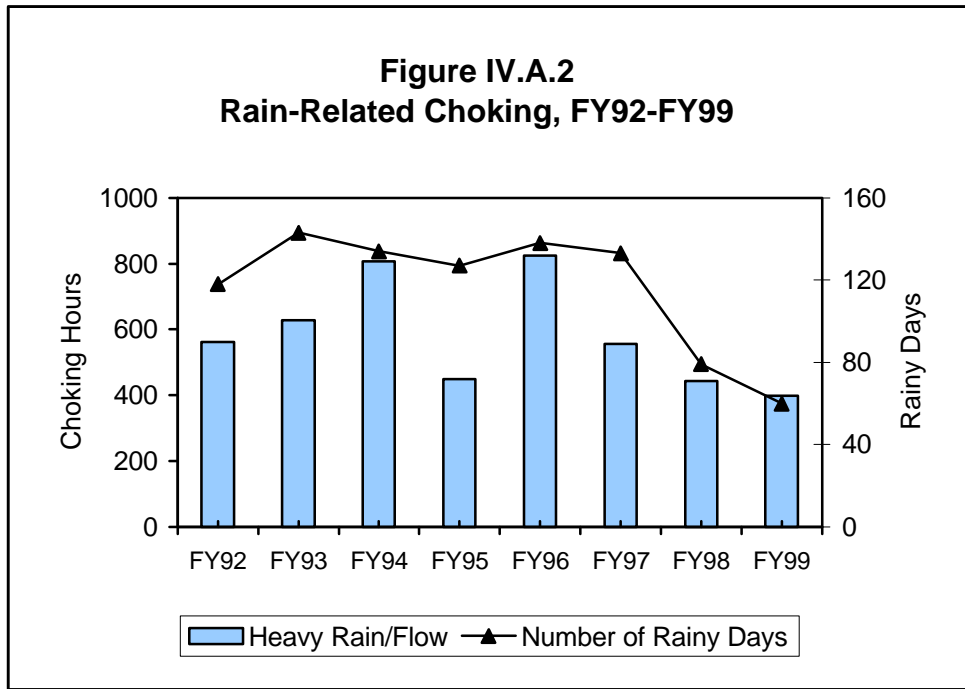

Figure IV.A.2 shows the influence of the number of rainy days in a year on the hours of rain-related choking in that year. A rainy day is defined as a day with at least 0.1 inches of rainfall. As this figure shows, FY99 had fewer rainy days than previous years as well as less choking hours due to heavy rain.



Choking for maintenance purposes is plotted in Figure IV.A.3. Maintenance choking peaked in FY95 due to the maintenance and testing involved in bringing the new primary treatment plant on-line. The number of hours of maintenance-related choking has continued to be fairly high from FY96 to FY98 because of maintenance and testing related to the startup of the new primary and secondary treatment plants. In FY98, of the approximately 580 choking hours related to testing and maintenance, 442 hours were due to testing. Since there were no new systems to test in FY99, there was a significant decrease in the testing/maintenance choking hours from FY98 to FY99.

Although testing-related choking hours can be expected to decrease considerably in the future, we expect that FY00 will a significant number of choking hours due to testing of systems associated with the third battery of secondary treatment and the new 9.5-mile outfall tunnel.

**Figure IV.A.3
Testing/Maintenance Choking, FY92-FY99**

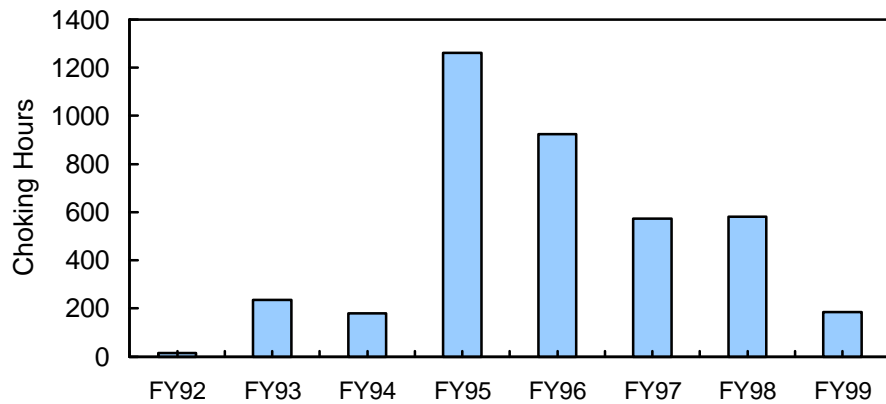

IV.A.2 Sanitary Sewer Overflows

Sanitary sewer overflows, which occur when the transport system is overwhelmed during extreme rainfall events, are monitored by MWRA visually and with meters in both the North System and the South System. Table IV.A.1 lists the number of recorded overflows at several locations in the North System, comparing FY99 with the previous fiscal year. Note that the number of overflows refers to the number of events, rather than the number of days; one overflow can last a number of days. There were no overflows in FY99 for the North System. This list includes only overflows at MWRA-owned overflow areas. There are also overflows for which the local municipalities are responsible for and which MWRA monitors less frequently, unless requested to do so by municipalities or notified of a problem by concerned citizens. A list of all the known overflow locations monitored by MWRA, including both MWRA and municipal overflows, is provided in Appendix J Table J-5.

Note that SSOs (sanitary sewer overflows) differ from CSOs (combined sewer overflows) in that CSO relief points are pipes that were specifically designed to relieve the sewer system. When the

system becomes overloaded, these pipes discharge combined sewage and storm water into a receiving body of water, such as the Charles River. SSOs, on the other hand, are weak points in the system, such as manholes, which will overflow during heavy rain events.

Location	Number of Overflows	
	FY98	FY99
Section C Medford	2	0
Section 107 Medford	3	0
Section 91B Medford (Siphon)	0	0
Section 43.5 Medford	0	0
Section B Cambridge	1	0
Section 113 Winchester	1	0
Section 80 Arlington	1	0

IV.B South System

IV.B.1 Sanitary Sewer Overflows

Table IV.B.1 lists the observed overflows in the South System. Note that the only overflows in FY99 for both the North and South Systems occurred at Section 126 Weymouth Smelt Brook.

Location	Number of Overflows	
	FY98	FY99
Section 126 Weymouth Smelt Brook	8	3
Section 126 Weymouth (Manhole)	0	0
Section 128 Braintree (Siphon)	0	0

Appendix A

- Table A-1 Deer Island Treatment Plant Operations Summary, Fiscal Year 1999
- Table A-2 Deer Island Influent Characterization (North & South Systems), Fiscal Year 1999
- Table A-3 Deer Island Influent Loadings (North & South Systems), Fiscal Year 1999
- Table A-4 Deer Island Influent Characterization (North System), Fiscal Year 1999
- Table A-5 Deer Island Influent Loadings (North System), Fiscal Year 1999
- Table A-6 Deer Island Influent Characterization (South System), Fiscal Year 1999
- Table A-7 Deer Island Influent Loadings (South System), Fiscal Year 1999
- Table A-8 Deer Island Effluent Characterization, Fiscal Year 1999
- Table A-9 Deer Island Effluent Loadings, Fiscal Year 1999
- Table A-10 Deer Island Influent Characterization (DEC), Fiscal Year 1999
- Table A-11 Deer Island Influent Loadings (DEC), Fiscal Year 1999
- Table A-12 Deer Island Effluent Characterization (DEC), Fiscal Year 1999
- Table A-13 Deer Island Effluent Loadings (DEC), Fiscal Year 1999

Table A-1 Deer Island Treatment Plant Operations Summary, Fiscal Year 1999

	JULY	AUG	SEPT	OCT	NOV	DEC	JAN	FEB	MAR	APR	MAY	JUNE	MIN	AVG	MAX
NORTH SYSTEM															
INFLUENT															
FLOW (mgd)															
AVERAGE	248.9	213.8	202.1	240.5	195.9	187.7	272.2	289.5	282.5	212.4	204.4	183.2		227.8	
MINIMUM	206.1	191.1	180.1	177.5	174.5	154.8	172.9	228.5	241.7	189.7	173.6	169.6	154.8		
MAXIMUM	406.1	360.6	374.4	507.2	274.8	304.7	510.5	541.6	356.1	251.9	347.3	236			541.6
TEMP (deg F)															
AVERAGE	67.6	69.9	68.5	66.9	62.6	60.6	58.9	60.1	59.7	58.2	63.3	68.3		63.7	
MINIMUM	60.1	59.4	59.4	63.7	59.9	57.4	53.9	53.8	50.7	54	59	64.8	50.7		
MAXIMUM	72.9	73	73.2	70.9	66.6	66.7	66.7	66.7	67.3	64	68.5	73			73.2
pH (units)															
AVERAGE	6.9	6.8	6.9	6.9	6.8	6.7	6.8	6.8	6.7	6.8	6.6	6.6		6.8	
MINIMUM	6.4	6.6	6.6	6.5	6.5	6.3	6.3	6.3	6.3	6.6	6.2	6.1	6.1		
MAXIMUM	7.5	7.7	7.2	7.2	7.1	7.3	7.1	7.1	7.1	7.3	7.1	6.9			7.7
CONVENTIONAL PARAMETERS (mg/L)															
TOTAL SOLIDS															
AVERAGE	1194	1393	1486	1409	1457	1353	1353	1258	1309	1413	1490	1359		1373	
MINIMUM	692	836	892.0	1020	1030	960	960	764	984	928	1080	1020	692		
MAXIMUM	2270	2130	2370	2820	2650	2030	2780	2510	2340	1940	2260	1850			2820
VOLATILE SOLIDS															
AVERAGE	312	379	412	366	390	388	315	307	301	373	448	502		374	
MINIMUM	76	212	180	200	208	232	216	172	196	204	292	316	76		
MAXIMUM	712	636	664	904	552	608	468	560	548	520	628	748			904
SETTLABLE SOLIDS (mL/L)															
AVERAGE	5.6	5.6	6.2	5.3	7.4	7.0	5.2	4.0	5.8	6.6	7.5	8.0		6.2	
MINIMUM	0.1	3.5	3.0	0.5	4.0	2.5	1.5	0.8	1.0	0.4	2.5	3.5	0.1		
MAXIMUM	16.0	10.0	9.0	13.0	23.0	18.0	11.0	6.0	22.0	25.0	40.0	21.0			40.0
TVSS															
AVERAGE	124	121	153	142	182	165	131	129	119	169	184	191		151	
MINIMUM	68	73	56	68	55	106	81	78	60	46	134	132	46		
MAXIMUM	200	247	237	218	470	236	268	224	196	284	242	308			470

Table A-1 Deer Island Treatment Plant Operations Summary, Fiscal Year 1999, cont.

	JULY	AUG	SEPT	OCT	NOV	DEC	JAN	FEB	MAR	APR	MAY	JUNE	MIN	AVG	MAX
NORTH SYSTEM															
INFLUENT															
TSS															
AVERAGE	144	142	175	164	209	185	156	150	137	191	209	216		173	
MINIMUM	90	83	70	82	65	112	102	86	73	54	152	148	54		
MAXIMUM	245	270	273	258	564	268	288	256	235	312	276	350			564
BOD															
AVERAGE	112	135	175	170	223	199	136	141	129	183	186	194		165	
MINIMUM	58	87	117	77	123	153	70	79	69	120	145	128	58		
MAXIMUM	172	203	255	295	506	304	198	257	270	283	269	282			506
CBOD															
AVERAGE	83	105	150	125	157	155	108	106	89	125	149	160		126	
MINIMUM	45	65	88	77	114	126	50	52	65	87	106	108	45		
MAXIMUM	130	140	249	218	227	267	173	158	170	184	188	247			267
COD															
AVERAGE	311	340	437	380	466	463	343	335	294	404	470	476		393	
MINIMUM	160	261	286	189	268	345	182	192	215	244	364	382	160		
MAXIMUM	631	581	596	553	955	746	683	838	423	574	954	662			955
FOG															
AVERAGE	25.5	33.0	34.7	43.9	41.8	39.9	28.6	29.2	31.3	50.5	47.0	46.2		37.6	
MINIMUM	15.2	19.0	26.4	24.1	29.2	26.9	18.0	19.0	15.0	39.0	27.0	24.0	15.0		
MAXIMUM	33.8	42.9	45.6	108.0	56.2	52.6	39.8	40.0	58.0	70.0	70.0	69.0			108.0
CHLORIDE															
AVERAGE	451	544	554	550	567	539	556	501	556	526	552	453		529	
MINIMUM	199	298	316	358	349	322	337	246	329	327	347	343	199		
MAXIMUM	895	876	911	1180	1130	892	1360	1230	1240	842	925	699			1360

Table A-1 Deer Island Treatment Plant Operations Summary, Fiscal Year 1999, cont.

	JULY	AUG	SEPT	OCT	NOV	DEC	JAN	FEB	MAR	APR	MAY	JUNE	MIN	AVG	MAX
NORTH SYSTEM															
INFLUENT															
NUTRIENTS (mg/L)															
AMMONIA															
AVERAGE	12.54	14.50	19.26	16.90	17.90	21.86	14.40	11.86	12.36	16.67	17.73	19.98		16.33	
MINIMUM	7.08	12.80	17.70	13.60	13.30	16.10	11.80	7.32	10.70	14.70	16.40	18.20	7.08		
MAXIMUM	16.20	16.20	22.60	19.50	20.30	31.50	17.20	14.80	13.20	18.40	21.30	21.20			31.50
NITRITES															
AVERAGE	0.03	0.06	0.01	0.08	0.07	0.02	0.09	0.18	0.12	0.06	0.01	0.03		0.06	
MINIMUM	0.01	0.01	0.01	0.01	0.01	0.01	0.01	0.01	0.01	0.01	0.01	0.01	0.01		
MAXIMUM	0.12	0.11	0.01	0.25	0.27	0.07	0.32	0.42	0.53	0.17	0.02	0.01			0.53
NITRATES															
AVERAGE	0.02	0.01	0.02	0.04	0.01	0.03	0.02	0.37	0.13	0.01	0.01	0.01		0.06	
MINIMUM	0.01	0.01	0.01	0.01	0.01	0.01	0.01	0.01	0.01	0.01	0.01	0.01	0.01		
MAXIMUM	0.06	0.01	0.07	0.08	0.03	0.12	0.05	1.42	0.62	0.01	0.01	0.01			1.42
ORTHOPHOSPHATE															
AVERAGE	1.18	1.88	2.32	2.23	2.47	2.41	1.61	1.32	1.40	2.03	1.96	2.41		1.93	
MINIMUM	0.71	1.65	1.79	1.55	2.14	1.53	1.12	0.63	1.28	1.47	1.80	1.95	0.63		
MAXIMUM	1.58	2.11	2.93	2.67	2.64	2.92	2.16	1.72	1.52	2.49	2.04	2.74			2.93
TKN															
AVERAGE	24.52	27.20	31.44	26.48	31.83	31.94	24.23	22.43	23.76	29.47	34.18	37.53		28.75	
MINIMUM	16.60	25.80	28.20	20.40	25.50	28.20	19.50	16.90	20.80	25.60	28.10	35.70	16.60		
MAXIMUM	35.90	28.60	38.00	30.70	38.20	37.80	31.00	25.70	28.70	32.40	45.00	41.60			45.00
TOTAL PHOSPHORUS															
AVERAGE	3.32	3.82	4.45	4.51	4.38	4.44	3.72	3.08	3.68	4.47	5.54	5.27		4.22	
MINIMUM	2.25	3.62	3.82	3.86	4.12	3.63	3.27	2.29	2.99	3.46	4.76	4.94	2.25		
MAXIMUM	3.84	4.01	5.25	5.26	4.66	5.04	4.22	3.52	4.42	5.17	7.78	5.79			7.78
TPH (IR)															
AVERAGE	2.18	1.43	2.23	2.07	2.67	3.07	7.20	5.63	3.10	5.83	2.40	6.50		3.69	
MINIMUM	1.70	1.00	1.80	2.00	2.30	2.00	1.90	2.30	1.40	2.70	1.90	4.70	1.00		
MAXIMUM	2.64	1.70	2.70	2.10	3.00	4.00	12.00	8.00	5.30	8.80	2.80	8.30			12.00

Table A-1 Deer Island Treatment Plant Operations Summary, Fiscal Year 1999, cont.

	JULY	AUG	SEPT	OCT	NOV	DEC	JAN	FEB	MAR	APR	MAY	JUNE	MIN	AVG	MAX
SOUTH SYSTEM															
INFLUENT															
FLOW (mgd)															
AVERAGE	140.2	101.7	93.8	125.9	97.3	92.1	159.0	168.0	172.5	118.4	104	87.9		121.7	
MINIMUM	100.9	90.1	87.7	86.7	92.9	83.0	91.6	134.1	148.7	102.3	96.1	78.1	78.1		
MAXIMUM	278.3	136.6	119.9	223.5	109.7	103.3	240.4	282.4	219.2	147.8	125.7	99.3			282.4
TEMP (deg F)															
AVERAGE	67.4	69.1	68.6	66	62.2	59.3	54.5	53.6	55.5	58	60.6	66.3		61.8	
MINIMUM	62.4	61.5	64.2	63.3	59.9	56.3	50	52.2	50.3	55	58.5	63	50		
MAXIMUM	72.7	72.7	71.2	69.8	65.6	62.4	66.2	57.5	65.1	62.4	63.5	74.7			74.7
pH (units)															
AVERAGE	6.7	6.8	6.9	6.9	6.8	6.7	6.7	6.5	6.7	6.6	6.4	6.5		6.7	
MINIMUM	6.3	6.4	6.7	6.3	6.5	6.2	6.2	6.1	6.3	6.2	6.2	6.2	6.1		
MAXIMUM	7.5	7.6	7.5	7.2	7.1	7.1	7.2	7.1	7	6.9	6.7	6.9			7.6
CONVENTIONAL PARAMETERS (mg/L)															
TOTAL SOLIDS															
AVERAGE	877	1065	1237	981	1190	1156	763	763	777	862	1146	1231		1004	
MINIMUM	424	756	912	692	836	916	544	476	648	780	984	964	424		
MAXIMUM	1210	1400	1850	1620	1900	1690	1200	1080	948	1100	1520	1670			1900
VOLATILE SOLIDS															
AVERAGE	222	270	335	267	317	342	201	190	202	246	345	376		276	
MINIMUM	56	160	168	140	208	228	116	96	136	192	276	252	56		
MAXIMUM	380	396	484	904	540	460	516	292	320	324	472	536			904
SETTLABLE SOLIDS (mL/L)															
AVERAGE	3.7	5.4	6.9	5.0	5.3	9.0	4.3	4.5	4.6	6.5	7.5	5.0		5.6	
MINIMUM	0.1	2.0	3.5	1.0	0.2	0.8	0.1	0.1	1.5	0.5	2.5	0.5	0.1		
MAXIMUM	10.0	11.0	12.0	21.0	23.0	18.0	11.0	7.5	6.0	11.0	10.0	9.0			23.0
TVSS															
AVERAGE	ND	107	139	109	141	168	77	77	82	104	149	144		118	
MINIMUM	ND	40	92	44	55	118	40	37	61	76	102	40	37		
MAXIMUM	ND	183	220	180	470	204	170	123	108	170	213	228			470

Table A-1 Deer Island Treatment Plant Operations Summary, Fiscal Year 1999, cont.

	JULY	AUG	SEPT	OCT	NOV	DEC	JAN	FEB	MAR	APR	MAY	JUNE	MIN	AVG	MAX
SOUTH SYSTEM															
INFLUENT															
TSS															
AVERAGE	98	132	170	132	167	195	93	90	97	123	174	166		136	
MINIMUM	22	48	106	50	65	134	47	45	71	90	122	42	22		
MAXIMUM	220	246	283	220	564	236	170	149	128	196	257	260			564
BOD															
AVERAGE	89	129	145	120	168	175	81	91	80	116	154	154		125	
MINIMUM	19	82	119	63	82	122	51	42	47	72	93	95	19		
MAXIMUM	199	315	246	223	506	238	245	179	130	186	197	216			506
CBOD															
AVERAGE	ND	88	119	98	127	139	64	69	58	91	131	136		102	
MINIMUM	ND	29	91	47	75	76	40	32	36	61	75	85	29		
MAXIMUM	ND	159	150	218	227	188	148	161	118	174	174	184			227
COD															
AVERAGE	241	333	434	311	398	474	236	225	208	318	437	428		337	
MINIMUM	84	229	311	162	229	298	151	105	167	181	294	284	84		
MAXIMUM	490	741	1112	481	955	746	457	345	278	486	635	522			1112
FOG															
AVERAGE	41.9	34.0	37.5	35.7	36.1	39.9	25.4	24.7	27.5	40.0	43.5	34.6		35.1	
MINIMUM	16.8	23.2	29.1	20.2	21.7	26.9	16.0	16.0	16.0	22.0	36.0	25.0	16.0		
MAXIMUM	104.0	40.8	46.0	48.5	56.2	58.2	31.8	33.0	41.0	51.0	58.0	42.0			104.0
CHLORIDE															
AVERAGE	327	412	469	351	440	435	287	306	303	304	401	450		374	
MINIMUM	157	301	316	256	290	305	218	205	238	269	327	338	157		
MAXIMUM	463	766	803	599	747	754	415	658	467	394	546	746			803

Table A-1 Deer Island Treatment Plant Operations Summary, Fiscal Year 1999, cont.

	JULY	AUG	SEPT	OCT	NOV	DEC	JAN	FEB	MAR	APR	MAY	JUNE	MIN	AVG	MAX
SOUTH SYSTEM															
INFLUENT															
NUTRIENTS (mg/L)															
AMMONIA															
AVERAGE	18.90	16.67	24.82	20.55	19.97	23.43	12.11	8.19	9.56	13.45	17.13	21.67		17.20	
MINIMUM	18.00	14.30	19.40	12.30	16.70	19.30	8.72	3.88	7.37	11.30	15.10	17.30	3.88		
MAXIMUM	19.80	18.50	28.20	28.80	23.20	29.40	16.50	11.20	12.30	15.60	19.90	25.70			29.40
NITRITES															
AVERAGE	0.01	0.01	0.01	0.01	0.01	0.01	0.15	0.09	0.09	0.01	0.02	0.01		0.04	
MINIMUM	0.01	0.01	0.01	0.01	0.01	0.01	0.01	0.01	0.01	0.01	0.01	0.01	0.01		
MAXIMUM	0.01	0.02	0.01	0.01	0.01	0.02	0.24	0.25	0.29	0.01	0.03	0.01			0.29
NITRATES															
AVERAGE	0.01	0.01	0.01	0.01	0.01	0.01	0.22	0.27	0.07	0.01	0.01	0.01		0.05	
MINIMUM	0.01	0.01	0.01	0.01	0.01	0.01	0.01	0.01	0.01	0.01	0.01	0.01	0.01		
MAXIMUM	0.01	0.01	0.01	0.01	0.01	0.01	0.63	0.80	0.30	0.01	0.01	0.01			0.80
ORTHOPHOSPHATE															
AVERAGE	3.03	2.38	3.32	2.63	2.70	2.42	1.42	0.82	0.87	1.77	2.26	2.90		2.21	
MINIMUM	3.03	2.19	2.78	1.41	2.69	1.76	0.95	0.24	0.59	1.46	1.92	2.55	0.24		
MAXIMUM	3.03	2.73	3.86	3.85	2.71	3.00	2.18	1.27	1.26	2.07	2.52	3.47			3.86
TKN															
AVERAGE	38.60	30.90	39.40	34.85	31.17	36.63	20.23	17.40	19.06	25.95	33.58	35.43		30.27	
MINIMUM	38.40	26.90	34.70	22.90	26.70	33.90	15.10	10.60	15.80	22.50	30.20	31.20	10.60		
MAXIMUM	38.80	34.60	43.70	46.80	34.20	41.90	27.40	21.80	23.50	29.40	35.90	39.60			46.80
TOTAL PHOSPHORUS															
AVERAGE	3.32	3.82	4.45	4.51	4.38	4.44	3.72	3.08	3.68	4.47	5.54	5.27		4.22	
MINIMUM	2.25	3.62	3.82	3.86	4.12	3.63	3.27	2.29	2.99	3.46	4.76	4.94	2.25		
MAXIMUM	3.84	4.01	5.25	5.26	4.66	5.04	4.22	3.52	4.42	5.17	7.78	5.79			7.78
TPH (IR)															
AVERAGE	3.21	3.07	3.00	3.60	3.13	3.07	6.60	2.27	1.75	4.87	2.80	6.07		3.62	
MINIMUM	2.90	2.40	2.40	3.30	2.30	2.00	3.30	1.30	1.50	2.80	1.80	3.00	1.30		
MAXIMUM	3.51	3.40	4.10	3.90	3.60	4.00	9.30	3.40	2.00	8.40	3.60	10.00			10.00

Table A-1 Deer Island Treatment Plant Operations Summary, Fiscal Year 1999, cont.

	JULY	AUG	SEPT	OCT	NOV	DEC	JAN	FEB	MAR	APR	MAY	JUNE	AVG
WEIGHTED INFLUENT													
CONVENTIONAL PARAMETERS (mg/L)													
TOTAL SOLIDS													
AVERAGE	1080	1287	1407	1262	1368	1288	1135	1076	1107	1216	1374	1317	1243
VOLATILE SOLIDS													
AVERAGE	194	183	187	201	183	181	200	203	205	185	195	182	192
SETTLEABLE SOLIDS (mL/L)													
AVERAGE	5.5	6.0	5.8	5.3	7.9	6.1	4.9	4.2	6.1	6.9	6.7	5.4	5.9
TVSS													
AVERAGE	~	116.5	148.6	130.7	168.4	166.0	111.1	109.9	105.0	145.7	172.2	175.8	140.9
TSS													
AVERAGE	127	139	173	153	195	188	133	128	122	167	197	200	160
BOD													
AVERAGE	104	133	165	153	205	191	116	123	110	159	175	181	151
CBOD													
AVERAGE	~	100	140	116	147	150	92	92	77	113	143	152	120
COD													
AVERAGE	286	338	436	356	443	467	304	295	261	373	459	460	373
FOG													
AVERAGE	31.4	33.3	35.6	41.1	39.9	39.9	27.4	27.5	29.9	46.7	45.8	42.4	36.8
CHLORIDE													
AVERAGE	406	501	527	482	525	505	457	429	460	447	501	452	474
AMMONIA													
AVERAGE	14.83	15.20	21.02	18.15	18.59	22.38	13.55	10.51	11.30	15.52	17.52	20.52	16.59
NITRITES													
AVERAGE	0.02	0.04	0.01	0.05	0.05	0.02	0.11	0.14	0.11	0.04	0.01	0.02	0.05
NITRATES													
AVERAGE	0.01	0.01	0.02	0.03	0.01	0.02	0.09	0.33	0.11	0.01	0.01	0.01	0.06
ORTHOPHOSPHATE													
AVERAGE	1.85	2.04	2.64	2.37	2.54	2.41	1.54	1.14	1.20	1.94	2.06	2.57	2.02
TKN													
AVERAGE	29.59	28.39	33.96	29.35	31.61	33.48	22.75	20.58	21.98	28.21	33.97	36.85	29.23
TOTAL PHOSPHORUS													
AVERAGE	3.32	3.82	4.45	4.51	4.38	4.44	3.72	3.08	3.68	4.47	5.54	5.27	4.22
TPH (IR)													
AVERAGE	2.55	1.96	2.47	2.60	2.82	3.07	6.98	4.40	2.59	5.49	2.53	6.36	3.65

Table A-1 Deer Island Treatment Plant Operations Summary, Fiscal Year 1999, cont.

	JULY	AUG	SEPT	OCT	NOV	DEC	JAN	FEB	MAR	APR	MAY	JUNE	MIN	AVG	MAX
EFFLUENT															
FLOW (mgd)															
AVERAGE	389.2	315.6	296.1	366.6	292.2	279.9	433.2	457.6	455	331.1	308.4	271.1		349.7	
MINIMUM	307.7	281.4	268.3	265.1	267.8	237.3	264.6	363.7	396.3	292.6	269.8	248.4	237.3		
MAXIMUM	684.4	497.8	494.3	713.6	366.7	402.8	729.4	756.9	551.6	387.3	472.3	317.6			756.9
TEMP (deg F)															
AVERAGE	68	70.9	70.6	67.1	63.9	61.2	55.4	55	55.2	59.1	63	68.2		63.1	
MINIMUM	62.1	69.4	61.2	60.8	61	56.1	49.5	50.7	53.4	56.8	61.2	64.8	49.5		
MAXIMUM	71.2	72.5	72.6	71.2	65.8	64	58.4	56.8	59.6	61.3	64.8	70.9			72.6
pH (units)															
AVERAGE	6.7	6.7	6.6	6.7	6.5	6.6	6.6	6.5	6.6	6.5	6.5	6.5		6.6	
MINIMUM	6.3	6.5	6.4	6.3	6.4	6.2	6.3	6.1	6.4	6.2	6.3	6.2	6.1		
MAXIMUM	7.1	7.3	6.9	7.9	6.7	6.9	6.9	7	6.8	6.8	7.1	6.8			7.9
CONVENTIONAL PARAMETERS (mg/L)															
TOTAL SOLIDS															
AVERAGE	1034	1105	1220	1005	1306	1162	1007	1015	999	1086	1109	1205		1104	
MINIMUM	564	828	872	820	1010	824	688	772	776	836	832	904	564		
MAXIMUM	1610	1400	2000	1700	2180	1750	1520	1920	1580	1480	1600	1770			2180
VOLATILE SOLIDS															
AVERAGE	197	202	198	173	194	197	177	171	179	180	195	258		193	
MINIMUM	48	104	100	64	136	72	100	116	88	124	136	132	48		
MAXIMUM	312	340	388	292	312	516	452	244	364	256	312	904			904
SETTLABLE SOLIDS (mL/L)															
AVERAGE	0.1	0.1	0.1	0.2	0.4	0.3	0.1	0.1	0.1	0.1	0.1	0.1		0.2	
MINIMUM	0.1	0.1	0.1	0.1	0.1	0.1	0.1	0.1	0.1	0.1	0.1	0.1	0.1		
MAXIMUM	0.2	0.2	0.5	2.4	3	1.5	0.4	1	0.3	0.2	0.5	0.2			3
TVSS															
AVERAGE	10.5	12.5	14.2	20.9	11.6	16.5	24.6	27.9	21.8	21.1	19.5	13.9		17.9	
MINIMUM	3.0	4.0	5.0	8.0	6.0	8.5	14.0	19.0	11.0	10.0	7.0	7.0	3.0		
MAXIMUM	24.0	32.0	38.0	42.0	21.0	42.0	50.0	40.0	30.0	32.0	30.0	26.0			50.0
TSS															
AVERAGE	12.5	14.9	17.1	24.5	13.6	19.6	31.6	33.5	26.2	24.7	24.1	15.8		21.5	
MINIMUM	3.0	4.0	7.0	10.0	8.0	10.0	18.0	23.0	11.0	10.0	8.0	8.0	3.0		
MAXIMUM	29.0	42.0	46.0	50.0	25.0	51.0	63.3	48.0	40.0	40.0	69.0	32.0			69.0

Table A-1 Deer Island Treatment Plant Operations Summary, Fiscal Year 1999, cont.

	JULY	AUG	SEPT	OCT	NOV	DEC	JAN	FEB	MAR	APR	MAY	JUNE	MIN	AVG	MAX
EFFLUENT															
BOD															
AVERAGE	17.4	22.4	20.1	41.2	24.6	33.2	30.8	41.8	35.3	35.5	33.2	25.0		30.0	
MINIMUM	9.5	10.7	10.7	19.0	14.2	23.4	20.4	24.0	21.2	26.6	15.2	11.5	9.5		
MAXIMUM	64.0	53.8	42.9	64.4	57.5	77.5	57.6	98.8	62.4	55.6	71.2	56.5			98.8
CBOD															
AVERAGE	14.9	13.1	13.7	30.3	18.2	24.3	26.2	34.9	30.2	28.8	21.9	14.7		22.6	
MINIMUM	8.1	7.6	8.0	7.6	10.3	9.8	17.6	21.8	21.2	21.1	8.1	5.4	5.4		
MAXIMUM	65.8	49.8	22.4	48.5	47.9	76.9	48.4	83.8	53.0	46.9	42.5	38.6			83.8
COD															
AVERAGE	84	87	91	120	93	116	114	130	119	128	110	95		107	
MINIMUM	55	70	65	80	78	88	75	93	100	101	71	69	55		
MAXIMUM	194	140	125	157	124	244	163	207	227	164	160	155			244
TOC															
AVERAGE	22.1	23.0	27.9	36.7	27.1	43.4	31.7	36.8	43.8	34.4	29.3	23.5		31.6	
MINIMUM	20.3	21.0	24.0	24.6	25.0	34.4	29.7	25.7	30.2	26.8	18.3	20.4	18.3		
MAXIMUM	24.1	25.5	32.8	48.1	28.9	68.0	34.8	49.5	66.3	43.1	36.1	26.9			68.0
FOG															
AVERAGE	7.1	7.1	9.6	10.5	9.9	10.6	8.7	9.5	11.6	15.7	11.1	8.1		10.0	
MINIMUM	7.0	7.0	8.4	7.0	7.0	7.7	7.2	8.1	7.0	13.0	7.0	7.0	7.0		
MAXIMUM	7.7	7.5	11.2	20.8	12.6	12.2	11.0	11.0	23.0	19.0	28.0	12.0			28.0
CHLORIDE															
AVERAGE	433	471	542	436	594	517	457	451	453	457	474	550		486	
MINIMUM	214	307	404	347	305	367	309	312	311	362	119	398	119		
MAXIMUM	595	589	939	779	978	798	783	941	830	634	714	797			978
TCOLIFORM (col/100ml)															
GEO MEAN	89	182	150	109	45	69	180	73	245	101	34	26		109	
MINIMUM	10	16	6	5	5	6	9	14	14	9	5	6	5		
MAXIMUM	8390	200033	186793	78501	2676	8920	16149	378	391878	56083	5100	96			391878
FCOLIFORM (col/100ml)															
GEO MEAN	8	11	11	7	8	7	6	5	9	7	7	5		8	
MINIMUM	5	5	5	5	5	5	5	5	5	5	5	5	5		
MAXIMUM	404	462	14812	75	74	222	39	7	4353	4958	215	8			14812

Table A-1 Deer Island Treatment Plant Operations Summary, Fiscal Year 1999, cont.

	JULY	AUG	SEPT	OCT	NOV	DEC	JAN	FEB	MAR	APR	MAY	JUNE	MIN	AVG	MAX
EFFLUENT															
NUTRIENTS (mg/L)															
AMMONIA															
AVERAGE	11.19	17.18	21.70	19.60	20.85	21.96	16.33	13.72	13.78	20.08	18.53	20.93		17.99	
MINIMUM	5.42	15.00	18.80	13.70	17.60	16.80	13.60	7.46	11.10	18.20	15.70	15.10	5.42		
MAXIMUM	19.50	20.00	25.50	25.20	24.40	26.40	18.80	17.70	16.00	22.20	20.60	24.00			26.40
NITRITES															
AVERAGE	0.06	0.27	0.18	0.25	0.18	0.19	0.10	0.06	0.11	0.11	1.28	0.83		0.30	
MINIMUM	0.01	0.01	0.05	0.02	0.05	0.06	0.02	0.03	0.07	0.05	0.40	0.48	0.01		
MAXIMUM	0.31	0.85	0.42	0.81	0.38	0.57	0.22	0.10	0.17	0.19	1.99	0.99			1.99
NITRATES															
AVERAGE	0.35	0.03	0.05	0.06	0.02	0.04	0.34	0.38	0.13	0.06	0.37	0.77		0.22	
MINIMUM	0.01	0.01	0.04	0.04	0.01	0.01	0.03	0.01	0.01	0.03	0.09	0.60	0.01		
MAXIMUM	1.93	0.09	0.07	0.08	0.04	0.14	0.98	1.35	0.38	0.13	0.67	1.04			1.93
ORTHOPHOSPHATE															
AVERAGE	1.27	1.86	2.47	2.36	2.49	2.36	1.66	1.23	1.30	2.18	1.90	2.60		1.97	
MINIMUM	0.71	1.65	1.87	1.64	2.33	2.24	1.30	0.73	1.04	1.84	1.80	2.26	0.71		
MAXIMUM	1.79	2.13	2.95	3.19	2.61	2.92	2.08	1.56	1.68	2.43	1.99	2.82			3.19
TKN															
AVERAGE	21.19	21.13	24.60	21.83	25.23	25.85	22.80	19.15	18.76	25.30	26.40	28.98		23.43	
MINIMUM	11.20	19.90	21.80	18.70	23.50	22.70	16.60	13.60	16.40	23.30	23.20	23.80	11.20		
MAXIMUM	29.00	23.20	25.60	26.20	26.30	29.00	28.30	25.00	22.20	27.60	32.10	34.30			34.30
TOTAL PHOSPHORUS															
AVERAGE	2.78	2.63	3.21	3.22	2.94	2.98	2.63	2.24	2.40	3.24	3.35	3.50		2.93	
MINIMUM	1.50	2.29	2.48	2.73	2.38	2.47	2.22	1.50	1.50	2.96	2.90	3.02	1.50		
MAXIMUM	4.08	2.97	3.72	3.73	3.48	3.39	3.02	2.85	3.47	3.38	4.30	3.88			4.30
TPH (IR)															
AVERAGE	1.38	1.13	1.07	1.23	1.97	1.07	1.93	1.98	1.24	1.08	1.00	1.00		1.34	
MINIMUM	1.00	1.00	1.00	1.00	1.00	1.00	1.30	1.00	1.00	1.00	1.00	1.00	1.00		
MAXIMUM	2.00	1.50	1.40	1.50	6.80	1.20	2.50	3.70	2.30	1.20	1.00	1.00			6.80

Notes:

ND = No Data

~ = Data Point Missing

Concentration expressed in mg/L unless otherwise noted.

Data are reduced from Deer Island Treatment Plant Monthly Operation Logs. All chemical analyses were conducted by Deer Island Central Laboratory.

Yearly averages in this table are computed from the monthly averages.

The coliform number for a given day is the geometric mean of the three grab samples taken on that day.

Table A-2 Deer Island Influent Characterization (North & South Systems), Fiscal Year 1999

Metals (ug/L)															Times Detected
	Jul	Aug	Sep	Oct	Nov	Dec	Jan	Feb	Mar	Apr	May	Jun	Average	Maximum	
ANTIMONY	20.00	20.00	20.00	20.00	12.27	8.92	8.38	12.42	11.19	7.50	7.37	7.50	13.08	20.00	0 of 134
ARSENIC	<i>1.17</i>	<i>1.43</i>	<i>0.85</i>	<i>1.08</i>	<i>0.84</i>	<i>1.72</i>	<i>1.40</i>	<i>0.55</i>	<i>0.91</i>	<i>0.61</i>	<i>1.41</i>	<i>1.25</i>	1.09	3.46	73 of 134
BERYLLIUM	0.50	0.50	0.50	0.50	0.36	0.25	0.25	0.33	0.25	0.25	0.25	<i>0.30</i>	0.35	0.50	1 of 134
BORON	<i>209.44</i>	<i>196.47</i>	<i>267.31</i>	<i>257.25</i>	<i>308.85</i>	<i>227.18</i>	<i>185.13</i>	<i>144.70</i>	<i>137.74</i>	<i>167.73</i>	<i>225.33</i>	<i>281.43</i>	213.01	390.97	75 of 134
CADMIUM	<i>1.46</i>	1.00	1.00	<i>1.18</i>	<i>1.67</i>	1.00	<i>1.05</i>	1.00	1.00	1.00	1.00	1.00	1.12	2.95	13 of 159
CHROMIUM	<i>5.25</i>	<i>3.26</i>	<i>4.44</i>	<i>3.47</i>	<i>4.08</i>	<i>5.86</i>	<i>4.84</i>	<i>4.74</i>	<i>8.71</i>	<i>4.78</i>	<i>8.05</i>	<i>4.19</i>	5.36	21.08	105 of 159
COPPER	<i>95.68</i>	<i>78.42</i>	<i>101.78</i>	<i>72.52</i>	<i>65.16</i>	<i>87.13</i>	<i>77.42</i>	<i>46.61</i>	<i>50.15</i>	<i>59.39</i>	<i>79.31</i>	<i>76.46</i>	73.27	152.88	159 of 159
HEXAVALENT CHROMIUM	5.50	5.50	5.50	5.50	5.50	5.50	5.50	5.50	5.50	5.50	5.50	5.50	5.50	5.50	0 of 64
IRON	<i>2316.00</i>	<i>2100.32</i>	<i>2209.77</i>	<i>1800.52</i>	<i>1471.34</i>	<i>1793.46</i>	<i>2316.29</i>	<i>1223.32</i>	<i>1624.67</i>	<i>1498.42</i>	<i>2300.08</i>	<i>1996.63</i>	1887.21	4232.10	134 of 134
LEAD	<i>23.28</i>	<i>20.63</i>	<i>26.95</i>	<i>18.44</i>	<i>10.13</i>	<i>11.15</i>	<i>15.50</i>	<i>6.11</i>	<i>10.93</i>	<i>9.58</i>	<i>30.04</i>	<i>11.87</i>	16.45	65.51	157 of 159
MERCURY	<i>0.34</i>	<i>0.26</i>	<i>0.44</i>	<i>0.24</i>	<i>0.22</i>	<i>0.39</i>	<i>0.31</i>	<i>0.17</i>	<i>0.19</i>	<i>0.21</i>	<i>0.32</i>	<i>0.29</i>	0.28	0.92	159 of 160
MOLYBDENUM	<i>6.43</i>	<i>10.95</i>	<i>9.20</i>	<i>12.53</i>	<i>7.27</i>	<i>6.09</i>	<i>6.05</i>	<i>2.83</i>	<i>3.91</i>	<i>4.66</i>	<i>9.97</i>	<i>9.02</i>	7.43	20.47	133 of 167
NICKEL	<i>7.05</i>	<i>5.01</i>	<i>4.24</i>	<i>5.65</i>	<i>4.82</i>	<i>4.94</i>	<i>4.88</i>	<i>3.27</i>	<i>4.68</i>	<i>4.48</i>	<i>7.52</i>	<i>6.85</i>	5.26	14.30	92 of 159
SELENIUM	<i>0.63</i>	0.50	0.87	0.57	<i>0.76</i>	0.45	0.45	0.45	0.44	0.52	0.45	<i>0.68</i>	0.56	3.31	7 of 134
SILVER	<i>3.37</i>	<i>2.62</i>	<i>4.29</i>	<i>4.87</i>	<i>3.65</i>	<i>4.66</i>	<i>3.43</i>	<i>2.63</i>	<i>3.37</i>	<i>4.67</i>	<i>4.02</i>	<i>4.81</i>	3.82	7.97	135 of 159
THALLIUM	0.50	<i>0.54</i>	0.94	<i>0.74</i>	0.50	0.50	<i>0.53</i>	0.50	0.50	0.50	0.50	0.50	0.56	3.52	4 of 134
ZINC	<i>128.75</i>	<i>111.77</i>	<i>134.74</i>	<i>98.78</i>	<i>87.15</i>	<i>118.50</i>	<i>120.60</i>	<i>76.05</i>	<i>100.07</i>	<i>113.47</i>	<i>150.47</i>	<i>122.51</i>	113.30	207.00	159 of 159
Cyanide and Phenols (ug/L)															
	Jul	Aug	Sep	Oct	Nov	Dec	Jan	Feb	Mar	Apr	May	Jun	Average	Maximum	Times Detected
CYANIDE	5.00	5.00	5.00	5.00	5.00	5.00	<i>6.73</i>	5.00	5.00	5.00	5.00	5.00	5.16	10.37	1 of 64
TOTAL PHENOLS	<i>14.31</i>	<i>36.71</i>	<i>28.75</i>	<i>41.47</i>	<i>41.86</i>	<i>40.38</i>	<i>36.98</i>	<i>18.30</i>	<i>6.02</i>	<i>23.57</i>	<i>31.31</i>	<i>43.10</i>	29.53	62.80	61 of 66
Oil and Grease, Petroleum Hydrocarbons, and Surfactants (mg/L)															
	Jul	Aug	Sep	Oct	Nov	Dec	Jan	Feb	Mar	Apr	May	Jun	Average	Maximum	Times Detected
PETROLEUM HYDROCARBON	<i>0.74</i>	<i>0.66</i>	<i>0.87</i>	<i>1.05</i>	<i>0.79</i>	<i>0.71</i>	<i>1.09</i>	<i>0.60</i>	<i>0.67</i>	<i>1.11</i>	<i>0.72</i>	<i>1.13</i>	0.85	1.53	64 of 64
TOTAL PETROLEUM HYDROCARBON	<i>2.52</i>	<i>2.25</i>	<i>2.36</i>	<i>2.49</i>	<i>2.82</i>	<i>3.08</i>	<i>6.85</i>	<i>4.42</i>	<i>2.72</i>	<i>5.44</i>	<i>2.32</i>	<i>6.34</i>	3.79	10.37	64 of 64
FATS OIL AND GREASE	<i>36.80</i>	<i>33.57</i>	<i>35.73</i>	<i>39.18</i>	<i>39.61</i>	<i>38.39</i>	<i>26.68</i>	<i>27.33</i>	<i>26.27</i>	<i>44.04</i>	<i>42.39</i>	<i>40.57</i>	34.98	82.00	131 of 131
MBAS	<i>3.70</i>	<i>4.33</i>	<i>4.31</i>	<i>3.22</i>	<i>4.12</i>	<i>52.34</i>	<i>4.15</i>	<i>3.11</i>	<i>2.39</i>	<i>4.11</i>	<i>4.21</i>	<i>5.01</i>	3.96	7.16	66 of 66

Table A-2 Deer Island Influent Characterization (North & South Systems), Fiscal Year 1999, cont.

Organochlorine Pesticides and PCBs (ug/L)													Average	Maximum	Times Detected
	Jul	Aug	Sep	Oct	Nov	Dec	Jan	Feb	Mar	Apr	May	Jun			
4,4'-DDD	0.002	0.002	0.002	0.002	0.002	0.003	0.002	0.002	0.002	0.002	0.002	0.002	0.002	0.004	0 of 66
4,4'-DDE	0.002	0.002	0.002	0.002	0.002	0.003	0.002	0.002	0.002	0.002	0.002	0.002	0.002	0.004	0 of 66
4,4'-DDT	0.002	0.002	0.002	0.002	0.002	0.003	0.002	0.002	0.002	0.002	0.002	0.002	0.002	0.004	0 of 66
ALDRIN	0.002	0.002	0.002	0.002	0.002	0.003	0.002	0.002	0.002	0.002	0.002	0.002	0.002	0.004	0 of 66
ALPHA-BHC	0.002	0.002	0.002	0.002	0.002	0.003	0.002	0.002	0.002	0.002	0.002	0.002	0.002	0.004	0 of 66
ALPHA-CHLORDANE	0.002	0.002	0.004	0.002	0.002	0.003	0.002	0.002	0.002	0.002	0.002	0.002	0.002	0.008	1 of 66
AROCLOR-1016	0.053	0.051	0.055	0.054	0.055	0.067	0.054	0.052	0.058	0.054	0.055	0.055	0.055	0.098	0 of 66
AROCLOR-1221	0.107	0.102	0.109	0.098	0.110	0.133	0.108	0.103	0.123	0.108	0.110	0.109	0.110	0.196	0 of 66
AROCLOR-1232	0.053	0.051	0.055	0.054	0.055	0.067	0.054	0.052	0.058	0.054	0.055	0.055	0.055	0.098	0 of 66
AROCLOR-1242	0.053	0.051	0.055	0.054	0.055	0.067	0.054	0.052	0.058	0.054	0.055	0.055	0.055	0.098	0 of 66
AROCLOR-1248	0.053	0.051	0.055	0.054	0.055	0.067	0.054	0.052	0.058	0.054	0.055	0.055	0.055	0.098	0 of 66
AROCLOR-1254	0.053	0.051	0.055	0.054	0.055	0.067	0.054	0.052	0.058	0.054	0.055	0.055	0.055	0.098	0 of 66
AROCLOR-1260	0.053	0.051	0.055	0.054	0.055	0.067	0.054	0.052	0.058	0.054	0.055	0.055	0.055	0.098	0 of 66
BETA-BHC	0.002	0.002	0.002	0.002	0.002	0.003	0.002	0.002	0.002	0.002	0.002	0.002	0.002	0.004	0 of 66
CHLORDANE (TECHNICAL)	0.053	0.051	0.055	0.054	0.055	0.067	0.054	0.052	0.058	0.054	0.055	0.055	0.055	0.098	0 of 66
DELTA-BHC	0.002	0.002	0.002	0.002	0.002	0.009	0.002	0.002	0.002	0.002	0.002	0.002	0.003	0.022	2 of 66
DIELDRIN	0.002	0.002	0.002	0.002	0.002	0.003	0.002	0.002	0.002	0.002	0.002	0.002	0.002	0.004	0 of 66
ENDOSULFAN I	0.002	0.002	0.002	0.002	0.002	0.003	0.002	0.002	0.002	0.002	0.002	0.002	0.002	0.004	0 of 66
ENDOSULFAN II	0.002	0.002	0.002	0.002	0.002	0.003	0.002	0.002	0.002	0.002	0.002	0.002	0.002	0.004	0 of 66
ENDOSULFAN SULFATE	0.002	0.002	0.002	0.002	0.002	0.003	0.002	0.002	0.002	0.002	0.002	0.002	0.002	0.004	0 of 66
ENDRIN	0.002	0.002	0.002	0.002	0.002	0.003	0.002	0.002	0.002	0.002	0.002	0.002	0.002	0.004	0 of 66
ENDRIN ALDEHYDE	0.002	0.002	0.002	0.002	0.002	0.003	0.002	0.002	0.002	0.002	0.002	0.002	0.002	0.004	0 of 66
ENDRIN KETONE	0.002	0.002	0.002	0.002	0.002	0.003	0.002	0.002	0.002	0.002	0.002	0.002	0.002	0.004	0 of 66
GAMMA-BHC (LINDANE)	0.002	0.002	0.002	0.002	0.002	0.023	0.002	0.002	0.002	0.002	0.002	0.008	0.004	0.040	6 of 66
GAMMA-CHLORDANE	0.002	0.002	0.003	0.002	0.002	0.003	0.002	0.002	0.002	0.002	0.002	0.002	0.002	0.006	1 of 66
HEPTACHLOR	0.002	0.002	0.002	0.002	0.002	0.003	0.002	0.002	0.002	0.002	0.002	0.002	0.002	0.004	0 of 66
HEPTACHLOR EPOXIDE	0.002	0.002	0.002	0.002	0.002	0.003	0.002	0.002	0.002	0.002	0.002	0.002	0.002	0.004	0 of 66
METHOXYCHLOR	0.021	0.020	0.022	0.022	0.022	0.027	0.022	0.021	0.023	0.022	0.022	0.022	0.022	0.039	0 of 66
TOXAPHENE	0.053	0.051	0.055	0.054	0.055	0.067	0.054	0.052	0.058	0.054	0.055	0.055	0.055	0.098	0 of 66

Table A-2 Deer Island Influent Characterization (North & South Systems), Fiscal Year 1999, cont.

Semivolatile Organics (ug/L)	Jul	Aug	Sep	Oct	Nov	Dec	Jan	Feb	Mar	Apr	May	Jun	Average	Maximum	Times Detected
1,2,4-TRICHLOROBENZENE	1.08	1.02	1.50	1.08	1.04	1.59	1.13	1.05	1.16	1.27	1.12	1.06	1.17	2.44	0 of 66
1,2-DICHLOROBENZENE	1.08	1.02	1.50	1.08	1.04	1.59	1.13	1.05	1.16	1.27	1.12	1.06	1.17	2.44	0 of 66
1,2-DIPHENYLHYDRAZINE (AS AZOB)	1.08	1.02	1.50	1.08	1.04	1.59	1.13	1.05	1.16	1.27	1.12	1.06	1.17	2.44	0 of 66
1,3-DICHLOROBENZENE	1.08	1.02	1.50	1.08	1.04	1.59	1.13	1.05	1.16	1.27	1.12	1.06	1.17	2.44	0 of 66
1,4-DICHLOROBENZENE	1.08	1.02	1.50	1.08	1.04	1.59	1.13	1.05	1.16	1.27	1.12	1.06	1.17	2.44	0 of 66
2,2'-OXYBIS(1-CHLOROPROPANE)	1.08	1.02	1.50	1.08	1.04	1.59	1.13	1.05	1.16	1.27	1.12	1.06	1.17	2.44	0 of 66
2,4,5-TRICHLOROPHENOL	1.08	1.02	1.50	1.08	1.04	1.59	1.13	1.05	1.16	1.27	1.12	1.06	1.17	2.44	0 of 66
2,4,6-TRICHLOROPHENOL	1.08	1.02	1.50	1.08	1.04	1.59	1.13	1.05	1.16	1.27	1.12	1.06	1.17	2.44	0 of 66
2,4-DICHLOROPHENOL	1.08	1.02	1.50	1.08	1.04	1.59	1.13	1.05	1.16	1.27	1.12	1.06	1.17	2.44	0 of 66
2,4-DIMETHYLPHENOL	1.08	1.02	1.50	1.08	1.04	1.59	1.13	1.05	1.16	1.27	1.12	1.06	1.17	2.44	0 of 66
2,4-DINITROPHENOL	2.16	2.03	3.01	2.16	2.07	3.18	2.25	2.11	2.33	2.54	2.25	2.11	2.35	4.88	0 of 66
2,4-DINITROTOLUENE	1.08	1.02	1.50	1.08	1.04	1.59	1.13	1.05	1.16	1.27	1.12	1.06	1.17	2.44	0 of 66
2,6-DINITROTOLUENE	1.08	1.02	1.50	1.08	1.04	1.59	1.13	1.05	1.16	1.27	1.12	1.06	1.17	2.44	0 of 66
2-CHLORONAPHTHALENE	1.08	1.02	1.50	1.08	1.04	1.59	1.13	1.05	1.16	1.27	1.12	1.06	1.17	2.44	0 of 66
2-CHLOROPHENOL	1.08	1.02	1.50	1.08	1.04	1.59	1.13	1.05	1.16	1.27	1.12	1.06	1.17	2.44	0 of 66
2-METHYL-4,6-DINITROPHENOL	10.82	10.16	15.05	10.79	10.35	15.92	11.26	10.53	11.63	12.71	11.25	10.57	11.74	24.40	0 of 66
2-METHYLNAPHTHALENE	1.08	1.02	1.50	1.08	1.04	1.59	1.13	1.05	1.16	1.27	1.12	1.06	1.17	2.44	0 of 66
2-METHYLPHENOL	1.08	1.02	1.50	1.08	1.04	1.59	1.13	1.05	1.16	1.27	1.12	1.06	1.17	2.44	0 of 66
2-NITROANILINE	1.08	1.02	1.50	1.08	1.04	1.59	1.13	1.05	1.16	1.27	1.12	1.06	1.17	2.44	0 of 66
2-NITROPHENOL	1.08	1.02	1.50	1.08	1.04	1.59	1.13	1.05	1.16	1.27	1.12	1.06	1.17	2.44	0 of 66
3,3'-DICHLOROBENZIDINE	2.16	2.03	3.01	2.16	2.07	3.18	2.25	2.11	2.33	2.54	2.25	2.11	2.35	4.88	0 of 66
3-NITROANILINE	1.08	1.02	1.50	1.08	1.04	1.59	1.13	1.05	1.16	1.27	1.12	1.06	1.17	2.44	0 of 66
4-BROMOPHENYL PHENYL ETHER	1.08	1.02	1.50	1.08	1.04	1.59	1.13	1.05	1.16	1.27	1.12	1.06	1.17	2.44	0 of 66
4-CHLORO-3-METHYLPHENOL	1.08	1.02	1.50	1.08	1.04	1.59	1.13	1.05	1.16	1.27	1.12	1.06	1.17	2.44	0 of 66
4-CHLOROANILINE	1.08	1.02	1.50	1.08	1.04	1.59	1.13	1.05	1.16	1.27	1.12	1.06	1.17	2.44	0 of 66
4-CHLOROPHENYL PHENYL ETHER	1.08	1.02	1.50	1.08	1.04	1.59	1.13	1.05	1.16	1.27	1.12	1.06	1.17	2.44	0 of 66
4-METHYLPHENOL (INCLUDES 3-MET)	4.03	16.08	18.60	11.76	23.37	30.52	20.09	13.21	6.57	14.90	14.07	25.10	16.27	34.69	58 of 66
4-NITROANILINE	1.08	1.02	1.50	1.08	1.04	1.59	1.13	1.05	1.16	1.27	1.12	1.06	1.17	2.44	0 of 66
4-NITROPHENOL	2.16	2.03	3.01	2.16	2.07	3.18	2.25	2.11	2.33	2.54	2.25	2.11	2.35	4.88	0 of 66
ACENAPHTHENE	1.08	1.02	1.50	1.08	1.04	1.59	1.13	1.05	1.16	1.27	1.12	1.06	1.17	2.44	0 of 66
ACENAPHTHYLENE	1.08	1.02	1.50	1.08	1.04	1.59	1.13	1.05	1.16	1.27	1.12	1.06	1.17	2.44	0 of 66
ANILINE	1.08	1.02	1.50	1.08	1.04	1.59	1.13	1.05	1.16	1.27	1.12	1.06	1.17	2.44	0 of 66
ANTHRACENE	1.08	1.02	1.50	1.08	1.04	1.59	1.13	1.05	1.16	1.27	1.12	1.06	1.17	2.44	0 of 66
BENZIDINE	5.41	5.08	7.52	5.39	5.18	7.96	5.63	5.27	5.81	6.36	5.62	5.28	5.87	12.20	0 of 66
BENZO(A)ANTHRACENE	1.08	1.02	1.50	1.08	1.04	1.59	1.13	1.05	1.16	1.27	1.12	1.06	1.17	2.44	0 of 66

Table A-2 Deer Island Influent Characterization (North & South Systems), Fiscal Year 1999, cont.

Semivolatile Organics (ug/L)	Jul	Aug	Sep	Oct	Nov	Dec	Jan	Feb	Mar	Apr	May	Jun	Average	Maximum	Times Detected
BENZO(A)PYRENE	1.08	1.02	1.50	1.08	1.04	1.59	1.13	1.05	1.16	1.27	1.12	1.06	1.17	2.44	0 of 66
BENZO(B)FLUORANTHENE	1.08	1.02	1.50	1.08	1.04	1.59	1.13	1.05	1.16	1.27	1.12	1.06	1.17	2.44	0 of 66
BENZO(GHI)PERYLENE	1.08	1.02	1.50	1.08	1.04	1.59	1.13	1.05	1.16	1.27	1.12	1.06	1.17	2.44	0 of 66
BENZO(K)FLUORANTHENE	1.08	1.02	1.50	1.08	1.04	1.59	1.13	1.05	1.16	1.27	1.12	1.06	1.17	2.44	0 of 66
BENZOIC ACID	2.16	7.22	15.31	3.41	5.41	36.00	9.89	2.11	5.95	2.54	14.06	2.11	8.90	63.76	26 of 66
BENZYL ALCOHOL	5.29	8.05	5.72	9.56	6.15	10.50	8.13	2.28	27.79	6.31	7.76	9.12	8.69	31.20	47 of 66
BIS(2-CHLOROETHOXY)METHANE	1.08	1.02	1.50	1.08	1.04	1.59	1.13	1.05	1.16	1.27	1.12	1.06	1.17	2.44	0 of 66
BIS(2-CHLOROETHYL)ETHER	1.08	1.02	1.50	1.08	1.04	1.59	1.13	1.05	1.16	1.27	1.12	1.06	1.17	2.44	0 of 66
BIS(2-ETHYLHEXYL)PHTHALATE	1.08	1.77	11.27	7.13	7.21	11.47	10.21	7.87	3.28	9.04	4.31	8.46	7.03	19.11	48 of 66
BUTYL BENZYL PHTHALATE	1.08	1.02	1.50	1.08	1.04	1.59	1.13	1.05	1.16	2.44	1.12	1.06	1.28	4.94	1 of 66
CHRYSENE	1.08	1.02	1.50	1.08	1.04	1.59	1.13	1.05	1.16	1.27	1.12	1.06	1.17	2.44	0 of 66
DIBENZO(A,H)ANTHRACENE	1.08	1.02	1.50	1.08	1.04	1.59	1.13	1.05	1.16	1.27	1.12	1.06	1.17	2.44	0 of 66
DIBENZOFURAN	1.08	1.02	1.50	1.08	1.04	1.59	1.13	1.05	1.16	1.27	1.12	1.06	1.17	2.44	0 of 66
DIETHYL PHTHALATE	1.08	1.02	1.50	1.08	1.04	1.59	1.13	1.05	1.16	1.27	1.12	1.06	1.17	2.44	0 of 66
DIMETHYL PHTHALATE	1.08	1.02	1.50	1.08	1.04	1.59	1.13	1.05	1.16	1.27	1.12	1.06	1.17	2.44	0 of 66
DI-N-BUTYLPHTHALATE	1.08	1.48	5.21	1.52	1.04	1.59	2.78	1.05	1.16	2.21	1.50	4.08	2.04	6.90	14 of 66
DI-N-OCTYLPHTHALATE	1.08	1.02	1.50	1.08	1.04	1.59	1.13	1.05	1.16	1.27	1.12	1.06	1.17	2.44	0 of 66
FLUORANTHENE	1.08	1.02	1.50	1.08	1.04	1.59	1.13	1.05	1.16	1.27	1.12	1.06	1.17	2.44	0 of 66
FLUORENE	1.08	1.02	1.50	1.08	1.04	1.59	1.13	1.05	1.16	1.27	1.12	1.06	1.17	2.44	0 of 66
HEXACHLOROBENZENE	1.08	1.02	1.50	1.08	1.04	1.59	1.13	1.05	1.16	1.27	1.12	1.06	1.17	2.44	0 of 66
HEXACHLOROBUTADIENE	1.08	1.02	1.50	1.08	1.04	1.59	1.13	1.05	1.16	1.27	1.12	1.06	1.17	2.44	0 of 66
HEXACHLOROCYCLOPENTADIENE	5.41	5.08	7.52	5.39	5.18	7.96	5.63	1.05	5.81	6.36	5.62	5.28	5.87	12.20	0 of 66
HEXACHLOROETHANE	1.08	1.02	1.50	1.08	1.04	1.59	1.13	1.05	1.16	1.27	1.12	1.06	1.17	2.44	0 of 66
INDENO(1,2,3-CD)PYRENE	1.08	1.02	1.50	1.08	1.04	1.59	1.13	1.05	1.16	1.27	1.12	1.06	1.17	2.44	0 of 66
ISOPHORONE	1.08	1.02	1.50	1.08	1.04	1.59	1.13	1.05	1.16	1.27	1.12	1.06	1.17	2.44	0 of 66
NAPHTHALENE	1.08	1.02	1.50	1.08	1.04	1.59	1.13	1.05	1.16	1.27	1.12	1.06	1.17	2.44	0 of 66
NITROBENZENE	1.08	1.02	1.50	1.08	1.04	1.59	1.13	1.05	1.16	1.27	1.12	1.06	1.17	2.44	0 of 66
N-NITROSODIMETHYLAMINE	1.08	1.02	1.50	1.08	1.04	1.59	1.13	1.05	1.16	1.27	1.12	1.06	1.17	2.44	0 of 66
N-NITROSODI-N-PROPYLAMINE	1.08	1.02	1.50	1.08	1.04	1.59	1.13	1.05	1.16	1.27	1.12	1.06	1.17	2.44	0 of 66
N-NITROSODIPHENYLAMINE	1.08	1.02	1.50	1.08	1.04	1.59	1.13	1.05	1.16	1.27	1.12	1.06	1.17	2.44	0 of 66
PENTACHLOROPHENOL	5.41	5.08	7.52	3.24	3.11	4.77	3.38	1.05	3.49	3.81	3.37	3.17	4.06	11.28	0 of 66
PHENANTHRENE	0.40	0.10	0.15	0.11	0.10	0.16	0.11	1.05	0.12	0.13	0.11	0.11	0.14	0.74	0 of 66
PHENOL	2.16	3.81	3.01	2.48	2.96	6.88	3.19	1.05	2.33	2.54	2.97	4.04	3.16	8.12	13 of 66
PYRENE	1.08	1.02	1.50	1.08	1.04	1.59	1.13	1.05	1.16	1.27	1.12	1.06	1.17	2.44	0 of 66

Table A-2 Deer Island Influent Characterization (North & South Systems), Fiscal Year 1999, cont.

Volatile Organics (ug/L)													Average	Maximum	Times	
	Jul	Aug	Sep	Oct	Nov	Dec	Jan	Feb	Mar	Apr	May	Jun			Detected	
1,1,1-TRICHLOROETHANE	0.50	0.50	0.50	0.50	0.50	0.50	0.50	0.50	0.50	0.50	0.50	0.50	0.50	0.50	0.50	0 of 64
1,1,2,2-TETRACHLOROETHANE	0.50	0.50	0.50	0.50	0.50	0.50	0.50	0.50	0.50	0.50	0.50	0.50	0.50	0.50	0.50	0 of 64
1,1,2-TRICHLOROETHANE	0.50	0.50	0.50	0.50	0.50	0.50	0.50	0.50	0.50	0.50	0.50	0.50	0.50	0.50	0.50	0 of 64
1,1-DICHLOROETHANE	0.50	0.50	0.50	0.50	0.50	0.50	0.50	0.50	0.50	0.50	0.50	0.50	0.50	0.50	0.50	0 of 64
1,1-DICHLOROETHENE	0.50	0.50	0.50	0.50	0.50	0.50	0.50	0.50	0.50	0.98	0.50	0.50	0.55	1.94	1 of 64	
1,2-DICHLOROBENZENE	0.50	0.50	0.50	0.50	0.50	0.50	0.50	0.50	0.50	0.50	0.50	0.50	0.50	0.50	0.50	0 of 64
1,2-DICHLOROETHANE	0.50	0.50	0.50	0.50	0.50	0.50	0.50	0.50	0.50	0.50	0.50	0.50	0.50	0.50	0.50	0 of 64
1,2-DICHLOROPROPANE	0.50	0.50	0.50	0.50	0.50	0.50	0.50	0.50	0.50	0.50	0.50	0.50	0.50	0.50	0.50	0 of 64
1,3-DICHLOROBENZENE	0.50	0.50	0.50	0.50	0.50	0.50	0.50	0.50	0.50	0.50	0.50	0.50	0.50	0.50	0.50	0 of 64
1,4-DICHLOROBENZENE	1.38	0.50	0.79	0.50	0.50	0.50	0.50	0.50	1.11	0.50	0.50	1.28	0.69	1.93	6 of 64	
2-BUTANONE	0.50	3.43	7.31	4.34	5.22	3.89	2.64	3.66	0.50	6.23	4.59	4.68	4.01	9.33	36 of 64	
2-CHLOROETHYL VINYL ETHER	0.50	0.50	0.50	0.50	0.50	0.50	0.50	0.50	0.50	0.50	0.50	0.50	0.50	0.50	0.50	0 of 64
2-HEXANONE	0.50	0.50	0.50	0.50	0.50	0.50	0.50	0.50	0.50	0.50	0.50	0.50	0.50	0.50	0.50	0 of 64
4-METHYL-2-PENTANONE	0.50	0.50	0.50	0.50	0.50	0.50	0.50	0.50	0.50	0.50	0.50	0.50	0.50	0.50	0.50	0 of 64
ACETONE	178.51	190.83	194.61	192.89	133.89	102.73	135.09	100.91	141.51	134.54	120.57	119.94	139.28	298.86	64 of 64	
ACROLEIN	0.50	0.50	0.50	0.50	0.50	0.50	0.50	0.50	0.50	0.50	0.50	0.50	0.50	0.50	0.50	0 of 64
ACRYLONITRILE	0.50	0.50	0.50	0.50	0.50	0.50	0.50	0.50	0.50	0.50	0.50	0.50	0.50	0.50	0.50	0 of 64
BENZENE	0.50	0.50	0.50	0.50	0.50	0.50	0.50	0.50	0.50	0.50	0.50	0.50	0.50	0.50	0.50	0 of 64
BROMODICHLOROMETHANE	0.50	0.50	0.50	0.50	0.50	0.50	1.19	0.50	0.50	0.50	0.50	0.50	0.57	2.65	1 of 64	
BROMOFORM	0.50	0.50	0.50	0.50	0.50	0.50	0.50	0.50	0.50	0.50	0.50	0.50	0.50	0.50	0.50	0 of 64
BROMOMETHANE	0.50	0.50	0.50	0.50	0.50	0.50	0.50	0.50	0.50	0.50	0.50	0.50	0.50	0.50	0.50	0 of 64
CARBON DISULFIDE	3.34	0.50	3.25	0.50	5.28	1.72	1.47	0.97	0.50	3.14	0.50	3.86	2.06	11.11	21 of 64	
CARBON TETRACHLORIDE	0.50	0.50	0.50	0.50	0.50	0.50	0.50	0.50	0.50	0.50	0.50	0.50	0.50	0.50	0.50	0 of 64
CHLOROBENZENE	0.50	0.50	0.50	0.50	0.50	0.50	0.50	0.50	0.50	0.50	0.50	0.50	0.50	0.50	0.50	0 of 64
CHLOROETHANE	0.50	0.50	0.50	0.50	0.50	0.50	0.50	0.50	0.50	0.50	0.50	0.50	0.50	0.50	0.50	0 of 64
CHLOROFORM	7.49	6.18	7.35	6.13	6.85	7.47	6.32	4.27	4.77	7.24	9.55	8.95	6.88	10.87	64 of 64	
CHLOROMETHANE	0.50	0.50	0.50	0.50	0.50	0.50	0.50	0.50	0.50	0.50	1.28	0.50	0.59	3.75	1 of 64	
CIS-1,2-DICHLOROETHENE	0.50	0.50	0.50	0.50	0.50	0.50	0.92	0.50	0.50	0.50	0.50	0.50	0.54	1.81	1 of 64	
CIS-1,3-DICHLOROPROPENE	0.50	0.50	0.50	0.50	0.50	0.50	0.50	0.50	0.50	0.50	0.50	0.50	0.50	0.50	0.50	0 of 64
DIBROMOCHLOROMETHANE	0.50	0.50	0.50	0.50	0.50	0.50	0.50	0.50	0.50	0.50	0.50	0.50	0.50	0.50	0.50	0 of 64
ETHYLBENZENE	0.50	0.50	0.50	0.50	0.50	0.50	0.50	0.50	0.50	0.50	0.50	0.50	0.50	0.50	0.50	0 of 64
M,P-XYLENE	0.50	0.50	0.50	0.50	0.50	0.50	0.50	0.50	1.13	0.50	0.50	0.92	0.58	1.78	2 of 64	
METHYLENE CHLORIDE	3.58	8.66	5.69	2.53	13.52	3.66	1.40	3.11	2.60	10.99	8.71	7.44	5.91	20.29	42 of 64	
O-XYLENE	0.50	0.50	0.50	0.50	0.50	0.50	0.50	0.50	0.50	0.50	0.50	0.50	0.50	0.50	0.50	0 of 64

Table A-2 Deer Island Influent Characterization (North & South Systems), Fiscal Year 1999, cont.

Volatile Organics (ug/L)															Times	
	Jul	Aug	Sep	Oct	Nov	Dec	Jan	Feb	Mar	Apr	May	Jun	Average	Maximum	Detected	
STYRENE	0.50	0.50	0.50	0.50	0.50	0.50	0.50	0.50	0.50	0.50	0.50	0.50	0.50	0.50	0.50	0 of 64
TETRACHLOROETHENE	<i>4.51</i>	<i>4.81</i>	<i>2.72</i>	<i>3.67</i>	<i>2.11</i>	<i>1.20</i>	<i>2.38</i>	<i>1.77</i>	<i>2.71</i>	<i>2.96</i>	<i>2.73</i>	<i>7.42</i>	3.04	19.12	38 of 64	
TOLUENE	<i>5.81</i>	<i>4.56</i>	<i>4.71</i>	<i>4.20</i>	<i>4.49</i>	<i>6.49</i>	<i>3.53</i>	<i>1.50</i>	<i>1.12</i>	<i>3.19</i>	<i>5.81</i>	<i>5.94</i>	4.13	7.71	54 of 64	
TRANS-1,2-DICHLOROETHENE	0.50	0.50	0.50	0.50	0.50	0.50	0.50	0.50	0.50	0.50	0.50	0.50	0.50	0.50	0.50	0 of 64
TRANS-1,3-DICHLOROPROPENE	0.50	0.50	0.50	0.50	0.50	0.50	0.50	0.50	0.50	0.50	0.50	0.50	0.50	0.50	0.50	0 of 64
TRICHLOROETHENE	0.50	0.50	<i>1.29</i>	0.50	0.50	<i>1.18</i>	0.50	0.50	<i>1.15</i>	<i>0.94</i>	0.50	<i>1.10</i>	0.76	2.85	6 of 64	
TRICHLOROFLUOROMETHANE	0.50	0.50	0.50	<i>3.30</i>	0.50	0.50	0.50	0.50	0.50	0.50	0.50	0.50	0.71	4.75	1 of 64	
VINYL ACETATE	0.50	0.50	0.50	0.50	0.50	0.50	0.50	0.50	0.50	0.50	0.50	0.50	0.50	0.50	0.50	0 of 64
VINYL CHLORIDE	0.50	0.50	0.50	0.50	0.50	0.50	0.50	0.50	0.50	0.50	0.50	0.50	0.50	0.50	0.50	0 of 64

Notes:

Results in *bold italics* indicate one or more detects in the month.

Yearly averages are calculated from individual results collected in the fiscal year.

Non-detected compounds are assumed to equal one half of the detection limit for metals and inorganics and one tenth of the reporting limit for organic compounds.

Table A-3 Deer Island Influent Loadings (North & South Systems), Fiscal Year 1999

Metals (lbs/day)													Times		
	Jul	Aug	Sep	Oct	Nov	Dec	Jan	Feb	Mar	Apr	May	Jun	Average	Maximum	Detected
ANTIMONY	60.70	50.21	48.34	65.39	29.53	21.25	28.42	44.03	44.91	21.48	20.60	17.13	37.89	94.68	0 of 134
ARSENIC	<i>3.54</i>	<i>3.58</i>	<i>2.05</i>	<i>3.52</i>	<i>2.03</i>	<i>4.11</i>	<i>4.73</i>	<i>1.95</i>	<i>3.64</i>	<i>1.74</i>	<i>3.94</i>	<i>2.84</i>	3.14	13.67	73 of 134
BERYLLIUM	1.52	1.26	1.21	1.63	0.86	0.60	0.85	1.15	1.00	0.72	0.70	<i>0.69</i>	1.02	2.37	1 of 134
BORON	<i>635.59</i>	<i>493.28</i>	<i>646.13</i>	<i>841.13</i>	<i>743.17</i>	<i>541.51</i>	<i>627.80</i>	<i>512.93</i>	<i>552.81</i>	<i>480.47</i>	<i>630.29</i>	<i>642.78</i>	617.04	1471.66	75 of 134
CADMIUM	<i>4.77</i>	2.92	2.82	<i>4.42</i>	<i>5.15</i>	3.28	<i>3.56</i>	3.54	4.70	3.60	3.85	2.73	3.79	12.28	13 of 159
CHROMIUM	<i>17.09</i>	<i>9.54</i>	<i>12.52</i>	<i>12.93</i>	<i>12.60</i>	<i>19.24</i>	<i>16.41</i>	<i>16.81</i>	<i>40.94</i>	<i>17.18</i>	<i>31.00</i>	<i>11.43</i>	18.20	103.13	105 of 159
COPPER	<i>311.38</i>	<i>229.36</i>	<i>287.13</i>	<i>270.27</i>	<i>201.22</i>	<i>286.22</i>	<i>262.56</i>	<i>165.22</i>	<i>235.74</i>	<i>213.66</i>	<i>305.61</i>	<i>208.73</i>	248.98	750.90	159 of 159
HEXAVALENT CHROMIUM	16.19	13.57	12.81	18.38	13.71	12.69	15.61	20.16	20.36	15.86	14.25	12.68	15.34	24.21	0 of 64
IRON	<i>7028.53</i>	<i>5273.25</i>	<i>5341.36</i>	<i>5887.03</i>	<i>3540.38</i>	<i>4275.01</i>	<i>7854.91</i>	<i>4336.40</i>	<i>6520.72</i>	<i>4292.16</i>	<i>6433.63</i>	<i>4560.27</i>	5466.75	17110.28	134 of 134
LEAD	<i>75.77</i>	<i>60.34</i>	<i>76.02</i>	<i>68.73</i>	<i>31.29</i>	<i>36.61</i>	<i>52.56</i>	<i>21.66</i>	<i>51.37</i>	<i>34.45</i>	<i>115.74</i>	<i>32.40</i>	55.90	517.15	157 of 159
MERCURY	<i>1.10</i>	<i>0.77</i>	<i>1.23</i>	<i>0.89</i>	<i>0.67</i>	<i>1.28</i>	<i>1.06</i>	<i>0.59</i>	<i>0.89</i>	<i>0.76</i>	<i>1.24</i>	<i>0.80</i>	0.95	4.04	159 of 160
MOLYBDENUM	<i>20.91</i>	<i>32.02</i>	<i>25.95</i>	<i>46.69</i>	<i>22.44</i>	<i>20.01</i>	<i>20.50</i>	<i>9.67</i>	<i>18.40</i>	<i>16.77</i>	<i>38.42</i>	<i>24.62</i>	25.18	96.92	133 of 167
NICKEL	<i>22.95</i>	<i>14.66</i>	<i>11.96</i>	<i>21.06</i>	<i>14.89</i>	<i>16.22</i>	<i>16.54</i>	<i>11.59</i>	<i>22.02</i>	<i>16.10</i>	<i>28.98</i>	<i>18.70</i>	17.88	68.91	92 of 159
SELENIUM	<i>1.91</i>	1.26	2.09	1.85	<i>1.83</i>	1.07	1.53	1.60	1.78	1.49	1.26	<i>1.54</i>	1.61	8.15	7 of 134
SILVER	<i>10.97</i>	<i>7.66</i>	<i>12.11</i>	<i>18.17</i>	<i>11.26</i>	<i>15.31</i>	<i>11.62</i>	<i>9.32</i>	<i>15.82</i>	<i>16.81</i>	<i>15.49</i>	<i>13.14</i>	12.97	31.33	135 of 159
THALLIUM	1.52	<i>1.35</i>	2.27	<i>2.42</i>	1.20	1.19	<i>1.78</i>	1.77	2.01	1.43	1.40	1.14	1.63	8.66	4 of 134
ZINC	<i>418.98</i>	<i>326.88</i>	<i>380.10</i>	<i>368.16</i>	<i>269.12</i>	<i>389.25</i>	<i>408.97</i>	<i>269.59</i>	<i>470.34</i>	<i>408.18</i>	<i>579.81</i>	<i>334.45</i>	385.01	1516.51	159 of 159

Cyanide and Phenols (lbs/day)													Times		
	Jul	Aug	Sep	Oct	Nov	Dec	Jan	Feb	Mar	Apr	May	Jun	Average	Maximum	Detected
CYANIDE	14.71	12.34	11.64	16.71	12.46	11.53	<i>19.09</i>	18.32	18.51	14.42	12.96	11.52	14.41	28.42	1 of 64
TOTAL PHENOLS	<i>47.11</i>	<i>90.58</i>	<i>71.17</i>	<i>145.58</i>	<i>105.36</i>	<i>100.44</i>	<i>123.70</i>	<i>68.27</i>	<i>23.30</i>	<i>68.95</i>	<i>81.56</i>	<i>98.24</i>	85.85	192.04	61 of 66

Oil and Grease, Petroleum Hydrocarbons, and Surfactants (lbs/day)													Times		
	Jul	Aug	Sep	Oct	Nov	Dec	Jan	Feb	Mar	Apr	May	Jun	Average	Maximum	Detected
PETROLEUM HYDROCARBON	<i>2181</i>	<i>1640</i>	<i>2021</i>	<i>3505</i>	<i>1959</i>	<i>1648</i>	<i>3100</i>	<i>2189</i>	<i>2495</i>	<i>3189</i>	<i>1873</i>	<i>2614</i>	2364	4657	64 of 64
TOTAL PETROLEUM HYDROCARBON	<i>7422</i>	<i>5544</i>	<i>5505</i>	<i>8322</i>	<i>7034</i>	<i>7107</i>	<i>19435</i>	<i>16187</i>	<i>10058</i>	<i>15690</i>	<i>6004</i>	<i>14621</i>	10559	28199	64 of 64
FATS OIL AND GREASE	<i>106539</i>	<i>95864</i>	<i>85628</i>	<i>125474</i>	<i>95027</i>	<i>87242</i>	<i>94991</i>	<i>95139</i>	<i>105812</i>	<i>123365</i>	<i>115345</i>	<i>92259</i>	102007	210519	131 of 131
MBAS	<i>12175</i>	<i>10673</i>	<i>10676</i>	<i>11306</i>	<i>10369</i>	<i>13019</i>	<i>13866</i>	<i>11598</i>	<i>9245</i>	<i>12013</i>	<i>10979</i>	<i>11420</i>	11512	18521	66 of 66

Table A-3 Deer Island Influent Loadings (North & South Systems), Fiscal Year 1999, cont.

Organochlorine Pesticides and PCBs (lbs/day)	Jul	Aug	Sep	Oct	Nov	Dec	Jan	Feb	Mar	Apr	May	Jun	Average	Maximum	Times Detected
4,4'-DDD	0.007	0.005	0.005	0.008	0.006	0.007	0.007	0.008	0.009	0.006	0.006	0.005	0.006	0.010	0 of 66
4,4'-DDE	0.007	0.005	0.005	0.008	0.006	0.007	0.007	0.008	0.009	0.006	0.006	0.005	0.006	0.010	0 of 66
4,4'-DDT	0.007	0.005	0.005	0.008	0.006	0.007	0.007	0.008	0.009	0.006	0.006	0.005	0.006	0.010	0 of 66
ALDRIN	0.007	0.005	0.005	0.008	0.006	0.007	0.007	0.008	0.009	0.006	0.006	0.005	0.006	0.010	0 of 66
ALPHA-BHC	0.007	0.005	0.005	0.008	0.006	0.007	0.007	0.008	0.009	0.006	0.006	0.005	0.006	0.010	0 of 66
ALPHA-CHLORDANE	0.007	0.005	0.010	0.008	0.006	0.007	0.007	0.008	0.009	0.006	0.006	0.005	0.007	0.018	1 of 66
AROCLOR-1016	0.176	0.126	0.135	0.189	0.139	0.166	0.181	0.193	0.223	0.159	0.143	0.125	0.160	0.254	0 of 66
AROCLOR-1221	0.352	0.252	0.271	0.343	0.277	0.331	0.361	0.385	0.476	0.317	0.286	0.249	0.319	0.508	0 of 66
AROCLOR-1232	0.176	0.126	0.135	0.189	0.139	0.166	0.181	0.193	0.223	0.159	0.143	0.125	0.160	0.254	0 of 66
AROCLOR-1242	0.176	0.126	0.135	0.189	0.139	0.166	0.181	0.193	0.223	0.159	0.143	0.125	0.160	0.254	0 of 66
AROCLOR-1248	0.176	0.126	0.135	0.189	0.139	0.166	0.181	0.193	0.223	0.159	0.143	0.125	0.160	0.254	0 of 66
AROCLOR-1254	0.176	0.126	0.135	0.189	0.139	0.166	0.181	0.193	0.223	0.159	0.143	0.125	0.160	0.254	0 of 66
AROCLOR-1260	0.176	0.126	0.135	0.189	0.139	0.166	0.181	0.193	0.223	0.159	0.143	0.125	0.160	0.254	0 of 66
BETA-BHC	0.007	0.005	0.005	0.008	0.006	0.007	0.007	0.008	0.009	0.006	0.006	0.005	0.006	0.010	0 of 66
CHLORDANE (TECHNICAL)	0.176	0.126	0.135	0.189	0.139	0.166	0.181	0.193	0.223	0.159	0.143	0.125	0.160	0.254	0 of 66
DELTA-BHC	0.007	0.005	0.005	0.008	0.006	0.022	0.007	0.008	0.009	0.006	0.006	0.005	0.008	0.052	2 of 66
DIELDRIN	0.007	0.005	0.005	0.008	0.006	0.007	0.007	0.008	0.009	0.006	0.006	0.005	0.006	0.010	0 of 66
ENDOSULFAN I	0.007	0.005	0.005	0.008	0.006	0.007	0.007	0.008	0.009	0.006	0.006	0.005	0.006	0.010	0 of 66
ENDOSULFAN II	0.007	0.005	0.005	0.008	0.006	0.007	0.007	0.008	0.009	0.006	0.006	0.005	0.006	0.010	0 of 66
ENDOSULFAN SULFATE	0.007	0.005	0.005	0.008	0.006	0.007	0.007	0.008	0.009	0.006	0.006	0.005	0.006	0.010	0 of 66
ENDRIN	0.007	0.005	0.005	0.008	0.006	0.007	0.007	0.008	0.009	0.006	0.006	0.005	0.006	0.010	0 of 66
ENDRIN ALDEHYDE	0.007	0.005	0.005	0.008	0.006	0.007	0.007	0.008	0.009	0.006	0.006	0.005	0.006	0.010	0 of 66
ENDRIN KETONE	0.007	0.005	0.005	0.008	0.006	0.007	0.007	0.008	0.009	0.006	0.006	0.005	0.006	0.010	0 of 66
GAMMA-BHC (LINDANE)	0.007	0.005	0.005	0.008	0.006	0.058	0.007	0.008	0.009	0.006	0.006	0.018	0.012	0.114	6 of 66
GAMMA-CHLORDANE	0.007	0.005	0.009	0.008	0.006	0.007	0.007	0.008	0.009	0.006	0.006	0.005	0.007	0.015	1 of 66
HEPTACHLOR	0.007	0.005	0.005	0.008	0.006	0.007	0.007	0.008	0.009	0.006	0.006	0.005	0.006	0.010	0 of 66
HEPTACHLOR EPOXIDE	0.007	0.005	0.005	0.008	0.006	0.007	0.007	0.008	0.009	0.006	0.006	0.005	0.006	0.010	0 of 66
METHOXYCHLOR	0.070	0.050	0.054	0.076	0.056	0.066	0.072	0.077	0.089	0.063	0.057	0.050	0.064	0.102	0 of 66
TOXAPHENE	0.176	0.126	0.135	0.189	0.139	0.166	0.181	0.193	0.223	0.159	0.143	0.125	0.160	0.254	0 of 66

Table A-3 Deer Island Influent Loadings (North & South Systems), Fiscal Year 1999, cont.

Semivolatile Organics (lbs/day)	Jul	Aug	Sep	Oct	Nov	Dec	Jan	Feb	Mar	Apr	May	Jun	Average	Maximum	Times Detected
1,2,4-TRICHLOROENZENE	3.56	2.51	3.73	3.79	2.61	3.96	3.77	3.93	4.50	3.72	2.93	2.41	3.41	6.38	0 of 66
1,2-DICHLOROENZENE	3.56	2.51	3.73	3.79	2.61	3.96	3.77	3.93	4.50	3.72	2.93	2.41	3.41	6.38	0 of 66
1,2-DIPHENYLHYDRAZINE (AS AZOB)	3.56	2.51	3.73	3.79	2.61	3.96	3.77	3.93	4.50	3.72	2.93	2.41	3.41	6.38	0 of 66
1,3-DICHLOROENZENE	3.56	2.51	3.73	3.79	2.61	3.96	3.77	3.93	4.50	3.72	2.93	2.41	3.41	6.38	0 of 66
1,4-DICHLOROENZENE	3.56	2.51	3.73	3.79	2.61	3.96	3.77	3.93	4.50	3.72	2.93	2.41	3.41	6.38	0 of 66
2,2'-OXYBIS(1-CHLOROPROPANE)	3.56	2.51	3.73	3.79	2.61	3.96	3.77	3.93	4.50	3.72	2.93	2.41	3.41	6.38	0 of 66
2,4,5-TRICHLOROPHENOL	3.56	2.51	3.73	3.79	2.61	3.96	3.77	3.93	4.50	3.72	2.93	2.41	3.41	6.38	0 of 66
2,4,6-TRICHLOROPHENOL	3.56	2.51	3.73	3.79	2.61	3.96	3.77	3.93	4.50	3.72	2.93	2.41	3.41	6.38	0 of 66
2,4-DICHLOROPHENOL	3.56	2.51	3.73	3.79	2.61	3.96	3.77	3.93	4.50	3.72	2.93	2.41	3.41	6.38	0 of 66
2,4-DIMETHYLPHENOL	3.56	2.51	3.73	3.79	2.61	3.96	3.77	3.93	4.50	3.72	2.93	2.41	3.41	6.38	0 of 66
2,4-DINITROPHENOL	7.13	5.02	7.45	7.57	5.21	7.92	7.54	7.86	9.00	7.44	5.86	4.82	6.83	12.76	0 of 66
2,4-DINITROTOLUENE	3.56	2.51	3.73	3.79	2.61	3.96	3.77	3.93	4.50	3.72	2.93	2.41	3.41	6.38	0 of 66
2,6-DINITROTOLUENE	3.56	2.51	3.73	3.79	2.61	3.96	3.77	3.93	4.50	3.72	2.93	2.41	3.41	6.38	0 of 66
2-CHLORONAPHTHALENE	3.56	2.51	3.73	3.79	2.61	3.96	3.77	3.93	4.50	3.72	2.93	2.41	3.41	6.38	0 of 66
2-CHLOROPHENOL	3.56	2.51	3.73	3.79	2.61	3.96	3.77	3.93	4.50	3.72	2.93	2.41	3.41	6.38	0 of 66
2-METHYL-4,6-DINITROPHENOL	35.63	25.08	37.25	37.86	26.05	39.59	37.68	39.29	44.98	37.18	29.30	24.09	34.14	63.78	0 of 66
2-METHYLNAPHTHALENE	3.56	2.51	3.73	3.79	2.61	3.96	3.77	3.93	4.50	3.72	2.93	2.41	3.41	6.38	0 of 66
2-METHYLPHENOL	3.56	2.51	3.73	3.79	2.61	3.96	3.77	3.93	4.50	3.72	2.93	2.41	3.41	6.38	0 of 66
2-NITROANILINE	3.56	2.51	3.73	3.79	2.61	3.96	3.77	3.93	4.50	3.72	2.93	2.41	3.41	6.38	0 of 66
2-NITROPHENOL	3.56	2.51	3.73	3.79	2.61	3.96	3.77	3.93	4.50	3.72	2.93	2.41	3.41	6.38	0 of 66
3,3'-DICHLOROENZIDINE	7.13	5.02	7.45	7.57	5.21	7.92	7.54	7.86	9.00	7.44	5.86	4.82	6.83	12.76	0 of 66
3-NITROANILINE	3.56	2.51	3.73	3.79	2.61	3.96	3.77	3.93	4.50	3.72	2.93	2.41	3.41	6.38	0 of 66
4-BROMOPHENYL PHENYL ETHER	3.56	2.51	3.73	3.79	2.61	3.96	3.77	3.93	4.50	3.72	2.93	2.41	3.41	6.38	0 of 66
4-CHLORO-3-METHYLPHENOL	3.56	2.51	3.73	3.79	2.61	3.96	3.77	3.93	4.50	3.72	2.93	2.41	3.41	6.38	0 of 66
4-CHLOROANILINE	3.56	2.51	3.73	3.79	2.61	3.96	3.77	3.93	4.50	3.72	2.93	2.41	3.41	6.38	0 of 66
4-CHLOROPHENYL PHENYL ETHER	3.56	2.51	3.73	3.79	2.61	3.96	3.77	3.93	4.50	3.72	2.93	2.41	3.41	6.38	0 of 66
4-METHYLPHENOL (INCLUDES 3-MET)	13.27	39.67	46.04	41.28	58.82	75.91	67.20	49.29	25.41	43.59	36.66	57.21	47.30	90.67	58 of 66
4-NITROANILINE	3.56	2.51	3.73	3.79	2.61	3.96	3.77	3.93	4.50	3.72	2.93	2.41	3.41	6.38	0 of 66
4-NITROPHENOL	7.13	5.02	7.45	7.57	5.21	7.92	7.54	7.86	9.00	7.44	5.86	4.82	6.83	12.76	0 of 66
ACENAPHTHENE	3.56	2.51	3.73	3.79	2.61	3.96	3.77	3.93	4.50	3.72	2.93	2.41	3.41	6.38	0 of 66
ACENAPHTHYLENE	3.56	2.51	3.73	3.79	2.61	3.96	3.77	3.93	4.50	3.72	2.93	2.41	3.41	6.38	0 of 66
ANILINE	3.56	2.51	3.73	3.79	2.61	3.96	3.77	3.93	4.50	3.72	2.93	2.41	3.41	6.38	0 of 66
ANTHRACENE	3.56	2.51	3.73	3.79	2.61	3.96	3.77	3.93	4.50	3.72	2.93	2.41	3.41	6.38	0 of 66
BENZIDINE	17.81	12.54	18.63	18.93	13.03	19.80	18.84	19.65	22.49	18.59	14.65	12.04	17.07	31.89	0 of 66
BENZO(A)ANTHRACENE	3.56	2.51	3.73	3.79	2.61	3.96	3.77	3.93	4.50	3.72	2.93	2.41	3.41	6.38	0 of 66

Table A-3 Deer Island Influent Loadings (North & South Systems), Fiscal Year 1999, cont.

Semivolatile Organics (lbs/day)	Semivolatile Organics (lbs/day)												Average	Maximum	Times Detected
	Jul	Aug	Sep	Oct	Nov	Dec	Jan	Feb	Mar	Apr	May	Jun			
BENZO(A)PYRENE	3.56	2.51	3.73	3.79	2.61	3.96	3.77	3.93	4.50	3.72	2.93	2.41	3.41	6.38	0 of 66
BENZO(B)FLUORANTHENE	3.56	2.51	3.73	3.79	2.61	3.96	3.77	3.93	4.50	3.72	2.93	2.41	3.41	6.38	0 of 66
BENZO(GHI)PERYLENE	3.56	2.51	3.73	3.79	2.61	3.96	3.77	3.93	4.50	3.72	2.93	2.41	3.41	6.38	0 of 66
BENZO(K)FLUORANTHENE	3.56	2.51	3.73	3.79	2.61	3.96	3.77	3.93	4.50	3.72	2.93	2.41	3.41	6.38	0 of 66
BENZOIC ACID	7.13	17.82	37.90	11.98	13.60	89.55	33.08	7.86	23.03	7.44	36.63	4.82	25.86	143.42	26 of 66
BENZYL ALCOHOL	17.41	19.85	14.15	33.55	15.47	26.13	27.21	8.52	107.50	18.46	20.22	20.79	25.28	128.56	47 of 66
BIS(2-CHLOROETHOXY)METHANE	3.56	2.51	3.73	3.79	2.61	3.96	3.77	3.93	4.50	3.72	2.93	2.41	3.41	6.38	0 of 66
BIS(2-CHLOROETHYL)ETHER	3.56	2.51	3.73	3.79	2.61	3.96	3.77	3.93	4.50	3.72	2.93	2.41	3.41	6.38	0 of 66
BIS(2-ETHYLHEXYL)PHTHALATE	3.56	4.36	27.91	25.02	18.16	28.54	34.16	29.38	12.67	26.45	11.22	19.28	20.42	59.80	48 of 66
BUTYL BENZYL PHTHALATE	3.56	2.51	3.73	3.79	2.61	3.96	3.77	3.93	4.50	7.13	2.93	2.41	3.72	14.79	1 of 66
CHRYSENE	3.56	2.51	3.73	3.79	2.61	3.96	3.77	3.93	4.50	3.72	2.93	2.41	3.41	6.38	0 of 66
DIBENZO(A,H)ANTHRACENE	3.56	2.51	3.73	3.79	2.61	3.96	3.77	3.93	4.50	3.72	2.93	2.41	3.41	6.38	0 of 66
DIBENZOFURAN	3.56	2.51	3.73	3.79	2.61	3.96	3.77	3.93	4.50	3.72	2.93	2.41	3.41	6.38	0 of 66
DIETHYL PHTHALATE	3.56	2.51	3.73	3.79	2.61	3.96	3.77	3.93	4.50	3.72	2.93	2.41	3.41	6.38	0 of 66
DIMETHYL PHTHALATE	3.56	2.51	3.73	3.79	2.61	3.96	3.77	3.93	4.50	3.72	2.93	2.41	3.41	6.38	0 of 66
DI-N-BUTYLPHTHALATE	3.56	3.66	12.91	5.33	2.61	3.96	9.31	3.93	4.50	6.45	3.91	9.30	5.94	16.54	14 of 66
DI-N-OCTYLPHTHALATE	3.56	2.51	3.73	3.79	2.61	3.96	3.77	3.93	4.50	3.72	2.93	2.41	3.41	6.38	0 of 66
FLUORANTHENE	3.56	2.51	3.73	3.79	2.61	3.96	3.77	3.93	4.50	3.72	2.93	2.41	3.41	6.38	0 of 66
FLUORENE	3.56	2.51	3.73	3.79	2.61	3.96	3.77	3.93	4.50	3.72	2.93	2.41	3.41	6.38	0 of 66
HEXACHLOROBENZENE	3.56	2.51	3.73	3.79	2.61	3.96	3.77	3.93	4.50	3.72	2.93	2.41	3.41	6.38	0 of 66
HEXACHLOROBUTADIENE	3.56	2.51	3.73	3.79	2.61	3.96	3.77	3.93	4.50	3.72	2.93	2.41	3.41	6.38	0 of 66
HEXACHLOROCYCLOPENTADIENE	17.81	12.54	18.63	18.93	13.03	19.80	18.84	19.65	22.49	18.59	14.65	12.04	17.07	31.89	0 of 66
HEXACHLOROETHANE	3.56	2.51	3.73	3.79	2.61	3.96	3.77	3.93	4.50	3.72	2.93	2.41	3.41	6.38	0 of 66
INDENO(1,2,3-CD)PYRENE	3.56	2.51	3.73	3.79	2.61	3.96	3.77	3.93	4.50	3.72	2.93	2.41	3.41	6.38	0 of 66
ISOPHORONE	3.56	2.51	3.73	3.79	2.61	3.96	3.77	3.93	4.50	3.72	2.93	2.41	3.41	6.38	0 of 66
NAPHTHALENE	3.56	2.51	3.73	3.79	2.61	3.96	3.77	3.93	4.50	3.72	2.93	2.41	3.41	6.38	0 of 66
NITROBENZENE	3.56	2.51	3.73	3.79	2.61	3.96	3.77	3.93	4.50	3.72	2.93	2.41	3.41	6.38	0 of 66
N-NITROSODIMETHYLAMINE	3.56	2.51	3.73	3.79	2.61	3.96	3.77	3.93	4.50	3.72	2.93	2.41	3.41	6.38	0 of 66
N-NITROSDI-N-PROPYLAMINE	3.56	2.51	3.73	3.79	2.61	3.96	3.77	3.93	4.50	3.72	2.93	2.41	3.41	6.38	0 of 66
N-NITROSODIPHENYLAMINE	3.56	2.51	3.73	3.79	2.61	3.96	3.77	3.93	4.50	3.72	2.93	2.41	3.41	6.38	0 of 66
PENTACHLOROPHENOL	17.81	12.54	18.63	11.36	7.82	11.88	11.30	11.79	13.49	11.15	8.79	7.23	11.81	31.89	0 of 66
PHENANTHRENE	1.30	0.25	0.37	0.38	0.26	0.40	0.38	0.39	0.45	0.37	0.29	0.24	0.40	2.23	0 of 66
PHENOL	7.13	9.40	7.45	8.71	7.44	17.12	10.69	7.86	9.00	7.44	7.74	9.21	9.18	23.37	13 of 66
PYRENE	3.56	2.51	3.73	3.79	2.61	3.96	3.77	3.93	4.50	3.72	2.93	2.41	3.41	6.38	0 of 66

Table A-3 Deer Island Influent Loadings (North & South Systems), Fiscal Year 1999, cont.

Volatile Organics (lbs/day)													Average	Maximum	Times Detected
	Jul	Aug	Sep	Oct	Nov	Dec	Jan	Feb	Mar	Apr	May	Jun			
1,1,1-TRICHLOROETHANE	1.47	1.23	1.16	1.67	1.25	1.15	1.42	1.83	1.85	1.44	1.30	1.15	1.39	2.20	0 of 64
1,1,2,2-TETRACHLOROETHANE	1.47	1.23	1.16	1.67	1.25	1.15	1.42	1.83	1.85	1.44	1.30	1.15	1.39	2.20	0 of 64
1,1,2-TRICHLOROETHANE	1.47	1.23	1.16	1.67	1.25	1.15	1.42	1.83	1.85	1.44	1.30	1.15	1.39	2.20	0 of 64
1,1-DICHLOROETHANE	1.47	1.23	1.16	1.67	1.25	1.15	1.42	1.83	1.85	1.44	1.30	1.15	1.39	2.20	0 of 64
1,1-DICHLOROETHENE	1.47	1.23	1.16	1.67	1.25	1.15	1.42	1.83	1.85	2.82	1.30	1.15	1.52	5.58	1 of 64
1,2-DICHLOROBENZENE	1.47	1.23	1.16	1.67	1.25	1.15	1.42	1.83	1.85	1.44	1.30	1.15	1.39	2.20	0 of 64
1,2-DICHLOROETHANE	1.47	1.23	1.16	1.67	1.25	1.15	1.42	1.83	1.85	1.44	1.30	1.15	1.39	2.20	0 of 64
1,2-DICHLOROPROPANE	1.47	1.23	1.16	1.67	1.25	1.15	1.42	1.83	1.85	1.44	1.30	1.15	1.39	2.20	0 of 64
1,3-DICHLOROBENZENE	1.47	1.23	1.16	1.67	1.25	1.15	1.42	1.83	1.85	1.44	1.30	1.15	1.39	2.20	0 of 64
1,4-DICHLOROBENZENE	4.06	1.23	1.83	1.67	1.25	1.15	1.42	1.83	4.12	1.44	1.30	2.94	1.93	6.35	6 of 64
2-BUTANONE	1.47	8.45	17.03	14.51	13.01	8.97	7.48	13.42	1.85	17.97	11.90	10.79	11.18	25.39	36 of 64
2-CHLOROETHYL VINYL ETHER	1.47	1.23	1.16	1.67	1.25	1.15	1.42	1.83	1.85	1.44	1.30	1.15	1.39	2.20	0 of 64
2-HEXANONE	1.47	1.23	1.16	1.67	1.25	1.15	1.42	1.83	1.85	1.44	1.30	1.15	1.39	2.20	0 of 64
4-METHYL-2-PENTANONE	1.47	1.23	1.16	1.67	1.25	1.15	1.42	1.83	1.85	1.44	1.30	1.15	1.39	2.20	0 of 64
ACETONE	525.33	470.93	453.12	644.61	333.75	236.96	383.33	369.83	523.86	387.94	312.43	276.46	388.51	683.57	64 of 64
ACROLEIN	1.47	1.23	1.16	1.67	1.25	1.15	1.42	1.83	1.85	1.44	1.30	1.15	1.39	2.20	0 of 64
ACRYLONITRILE	1.47	1.23	1.16	1.67	1.25	1.15	1.42	1.83	1.85	1.44	1.30	1.15	1.39	2.20	0 of 64
BENZENE	1.47	1.23	1.16	1.67	1.25	1.15	1.42	1.83	1.85	1.44	1.30	1.15	1.39	2.20	0 of 64
BROMODICHLOROMETHANE	1.47	1.23	1.16	1.67	1.25	1.15	3.39	1.83	1.85	1.44	1.30	1.15	1.58	7.27	1 of 64
BROMOFORM	1.47	1.23	1.16	1.67	1.25	1.15	1.42	1.83	1.85	1.44	1.30	1.15	1.39	2.20	0 of 64
BROMOMETHANE	1.47	1.23	1.16	1.67	1.25	1.15	1.42	1.83	1.85	1.44	1.30	1.15	1.39	2.20	0 of 64
CARBON DISULFIDE	9.82	1.23	7.56	1.67	13.17	3.97	4.18	3.55	1.85	9.07	1.30	8.91	5.76	27.32	21 of 64
CARBON TETRACHLORIDE	1.47	1.23	1.16	1.67	1.25	1.15	1.42	1.83	1.85	1.44	1.30	1.15	1.39	2.20	0 of 64
CHLOROBENZENE	1.47	1.23	1.16	1.67	1.25	1.15	1.42	1.83	1.85	1.44	1.30	1.15	1.39	2.20	0 of 64
CHLOROETHANE	1.47	1.23	1.16	1.67	1.25	1.15	1.42	1.83	1.85	1.44	1.30	1.15	1.39	2.20	0 of 64
CHLOROFORM	22.05	15.26	17.11	20.49	17.09	17.24	17.94	15.64	17.66	20.86	24.75	20.62	19.19	27.24	64 of 64
CHLOROMETHANE	1.47	1.23	1.16	1.67	1.25	1.15	1.42	1.83	1.85	1.44	3.31	1.15	1.65	9.31	1 of 64
CIS-1,2-DICHLOROETHENE	1.47	1.23	1.16	1.67	1.25	1.15	2.61	1.83	1.85	1.44	1.30	1.15	1.51	4.95	1 of 64
CIS-1,3-DICHLOROPROPENE	1.47	1.23	1.16	1.67	1.25	1.15	1.42	1.83	1.85	1.44	1.30	1.15	1.39	2.20	0 of 64
DIBROMOCHLOROMETHANE	1.47	1.23	1.16	1.67	1.25	1.15	1.42	1.83	1.85	1.44	1.30	1.15	1.39	2.20	0 of 64
ETHYLBENZENE	1.47	1.23	1.16	1.67	1.25	1.15	1.42	1.83	1.85	1.44	1.30	1.15	1.39	2.20	0 of 64
M,P-XYLENE	1.47	1.23	1.16	1.67	1.25	1.15	1.42	1.83	4.17	1.44	1.30	2.11	1.63	6.46	2 of 64
METHYLENE CHLORIDE	10.52	21.38	13.25	8.46	33.71	8.43	3.97	11.40	9.63	31.69	22.56	17.14	16.49	51.20	42 of 64
O-XYLENE	1.47	1.23	1.16	1.67	1.25	1.15	1.42	1.83	1.85	1.44	1.30	1.15	1.39	2.20	0 of 64
STYRENE	1.47	1.23	1.16	1.67	1.25	1.15	1.42	1.83	1.85	1.44	1.30	1.15	1.39	2.20	0 of 64
TETRACHLOROETHENE	13.29	11.87	6.34	12.28	5.26	2.78	6.77	6.50	10.04	8.54	7.08	17.09	8.48	43.71	38 of 64
TOLUENE	17.10	11.25	10.96	14.04	11.19	14.97	10.01	5.49	4.13	9.20	15.07	13.69	11.52	21.24	54 of 64
TRANS-1,2-DICHLOROETHENE	1.47	1.23	1.16	1.67	1.25	1.15	1.42	1.83	1.85	1.44	1.30	1.15	1.39	2.20	0 of 64
TRANS-1,3-DICHLOROPROPENE	1.47	1.23	1.16	1.67	1.25	1.15	1.42	1.83	1.85	1.44	1.30	1.15	1.39	2.20	0 of 64

Table A-3 Deer Island Influent Loadings (North & South Systems), Fiscal Year 1999, cont.

Volatile Organics (lbs/day)															Times
	Jul	Aug	Sep	Oct	Nov	Dec	Jan	Feb	Mar	Apr	May	Jun	Average	Maximum	Detected
TRICHLOROETHENE	1.47	1.23	3.00	1.67	1.25	2.73	1.42	1.83	4.24	2.71	1.30	2.53	2.11	6.69	6 of 64
TRICHLOROFLUOROMETHANE	1.47	1.23	1.16	11.02	1.25	1.15	1.42	1.83	1.85	1.44	1.30	1.15	1.98	20.89	1 of 64
VINYL ACETATE	1.47	1.23	1.16	1.67	1.25	1.15	1.42	1.83	1.85	1.44	1.30	1.15	1.39	2.20	0 of 64
VINYL CHLORIDE	1.47	1.23	1.16	1.67	1.25	1.15	1.42	1.83	1.85	1.44	1.30	1.15	1.39	2.20	0 of 64

Notes:

Results in *bold italics* indicate one or more detects in the month.

Yearly averages are calculated from individual results collected in the fiscal

Non-detected compounds are assumed to equal one half of the detection limit for metals and inorganics and one tenth of the reporting limit for organic

Table A-4 Deer Island Influent Characterization (North System), Fiscal Year 1999

Metals (ug/L)															Times
	Jul	Aug	Sep	Oct	Nov	Dec	Jan	Feb	Mar	Apr	May	Jun	Average	Maximum	Detected
ANTIMONY	20.00	20.00	20.00	20.00	11.65	8.87	8.70	11.66	11.69	7.50	7.50	7.50	13.11	20.00	0 of 79
ARSENIC	<i>1.20</i>	<i>1.70</i>	<i>0.81</i>	<i>1.02</i>	<i>1.08</i>	<i>1.98</i>	<i>1.67</i>	<i>0.61</i>	<i>1.07</i>	<i>0.84</i>	<i>1.64</i>	<i>1.23</i>	1.23	4.57	49 of 79
BERYLLIUM	0.50	0.50	0.50	0.50	0.34	0.25	0.25	0.29	0.25	0.25	0.25	<i>0.31</i>	0.35	0.62	1 of 79
BORON	<i>205.23</i>	<i>163.81</i>	<i>244.70</i>	<i>282.97</i>	<i>324.49</i>	<i>221.39</i>	<i>181.76</i>	<i>152.20</i>	<i>142.86</i>	<i>231.47</i>	<i>227.60</i>	<i>256.17</i>	214.65	409.00	46 of 79
CADMIUM	<i>1.54</i>	1.00	1.00	1.00	<i>1.58</i>	1.00	1.00	1.00	1.00	1.00	1.00	1.00	1.10	3.09	5 of 79
CHROMIUM	<i>4.76</i>	<i>3.40</i>	<i>4.21</i>	<i>3.59</i>	<i>4.94</i>	<i>6.43</i>	<i>5.64</i>	<i>5.59</i>	<i>11.45</i>	<i>6.32</i>	<i>7.66</i>	<i>4.05</i>	5.85	32.00	55 of 79
COPPER	<i>88.12</i>	<i>69.76</i>	<i>73.46</i>	<i>67.24</i>	<i>63.71</i>	<i>85.41</i>	<i>70.67</i>	<i>46.71</i>	<i>50.16</i>	<i>63.15</i>	<i>76.99</i>	<i>76.51</i>	68.35	135.00	79 of 79
HEXAVALENT CHROMIUM	5.50	5.50	5.50	5.50	5.50	5.50	5.50	5.50	5.50	5.50	5.50	5.50	5.50	5.50	0 of 36
IRON	<i>2246.92</i>	<i>2246.34</i>	<i>1757.34</i>	<i>1761.29</i>	<i>1367.73</i>	<i>1738.52</i>	<i>2458.49</i>	<i>1200.18</i>	<i>1622.04</i>	<i>1607.30</i>	<i>2322.82</i>	<i>1958.54</i>	1876.85	5070.00	80 of 80
LEAD	<i>22.98</i>	<i>32.06</i>	<i>20.52</i>	<i>19.74</i>	<i>11.76</i>	<i>12.51</i>	<i>21.54</i>	<i>5.65</i>	<i>12.61</i>	<i>15.90</i>	<i>29.15</i>	<i>12.25</i>	18.40	89.10	78 of 79
MERCURY	<i>0.27</i>	<i>0.30</i>	<i>0.30</i>	<i>0.23</i>	<i>0.26</i>	<i>0.45</i>	<i>0.38</i>	<i>0.13</i>	<i>0.17</i>	<i>0.25</i>	<i>0.31</i>	<i>0.25</i>	0.27	0.92	79 of 80
MOLYBDENUM	<i>8.23</i>	<i>13.54</i>	<i>10.69</i>	<i>14.55</i>	<i>10.25</i>	<i>8.13</i>	<i>7.12</i>	<i>3.86</i>	<i>5.79</i>	<i>7.01</i>	<i>12.58</i>	<i>8.96</i>	9.21	21.90	78 of 85
NICKEL	<i>7.54</i>	<i>6.05</i>	4.00	5.55	<i>4.99</i>	<i>5.14</i>	<i>6.60</i>	<i>3.43</i>	<i>4.54</i>	<i>4.67</i>	<i>8.91</i>	<i>7.46</i>	5.75	15.40	49 of 79
SELENIUM	<i>0.68</i>	0.51	1.03	0.50	<i>0.77</i>	0.45	0.45	0.45	0.44	0.53	0.45	<i>0.68</i>	0.57	4.50	5 of 79
SILVER	<i>2.88</i>	<i>2.56</i>	<i>3.18</i>	<i>4.52</i>	<i>4.43</i>	<i>5.57</i>	<i>3.09</i>	<i>3.03</i>	<i>4.18</i>	<i>5.17</i>	<i>4.91</i>	<i>4.83</i>	3.92	7.97	68 of 79
THALLIUM	0.50	0.50	1.14	<i>0.71</i>	0.50	0.50	0.50	0.50	0.50	0.50	0.50	0.50	0.57	5.00	1 of 79
ZINC	<i>122.42</i>	<i>117.78</i>	<i>102.80</i>	<i>94.56</i>	<i>88.81</i>	<i>118.68</i>	<i>120.64</i>	<i>74.95</i>	<i>104.34</i>	<i>120.43</i>	<i>142.52</i>	<i>120.71</i>	110.40	243.00	80 of 80
Cyanide and Phenols (ug/L)															
	Jul	Aug	Sep	Oct	Nov	Dec	Jan	Feb	Mar	Apr	May	Jun	Average	Maximum	Times Detected
CYANIDE	5.00	5.00	5.00	5.00	5.00	5.00	<i>7.70</i>	5.00	5.00	5.00	5.00	5.00	5.22	13.50	1 of 36
TOTAL PHENOLS	<i>11.76</i>	<i>36.03</i>	<i>23.99</i>	<i>39.84</i>	<i>45.70</i>	<i>39.93</i>	<i>36.17</i>	<i>18.74</i>	<i>9.17</i>	<i>31.42</i>	<i>26.38</i>	<i>32.65</i>	28.05	62.80	35 of 38
Oil and Grease, Petroleum Hydrocarbons, and Surfactants (mg/L)															
	Jul	Aug	Sep	Oct	Nov	Dec	Jan	Feb	Mar	Apr	May	Jun	Average	Maximum	Times Detected
PETROLEUM HYDROCARBON	<i>0.71</i>	<i>0.61</i>	<i>0.82</i>	<i>0.76</i>	<i>0.77</i>	<i>0.72</i>	<i>1.09</i>	<i>0.63</i>	<i>0.87</i>	<i>0.80</i>	<i>0.58</i>	<i>1.19</i>	0.79	1.70	36 of 36
TOTAL PETROLEUM HYDROCARBON	<i>2.36</i>	<i>1.70</i>	<i>2.24</i>	<i>2.05</i>	<i>2.67</i>	<i>3.08</i>	<i>7.07</i>	<i>5.72</i>	<i>3.10</i>	<i>5.81</i>	<i>2.14</i>	<i>6.49</i>	3.74	12.00	36 of 36
FATS OIL AND GREASE	<i>27.19</i>	<i>32.80</i>	<i>37.95</i>	<i>40.95</i>	<i>41.53</i>	<i>38.53</i>	<i>28.04</i>	<i>29.22</i>	<i>30.39</i>	<i>50.23</i>	<i>43.24</i>	<i>46.22</i>	36.20	108.00	73 of 73
MBAS	<i>3.92</i>	<i>3.99</i>	<i>4.33</i>	<i>3.43</i>	<i>4.00</i>	<i>5.18</i>	<i>4.18</i>	<i>3.36</i>	<i>2.27</i>	<i>4.37</i>	<i>3.98</i>	<i>4.66</i>	3.90	7.16	38 of 38

Table A-4 Deer Island Influent Characterization (North System), Fiscal Year 1999, cont.

Organochlorine Pesticides and PCBs (ug/L)													Times		
	Jul	Aug	Sep	Oct	Nov	Dec	Jan	Feb	Mar	Apr	May	Jun	Average	Maximum	Detected
4,4'-DDD	0.002	0.002	0.002	0.002	0.002	0.003	0.002	0.002	0.002	0.002	0.002	0.002	0.002	0.004	0 of 38
4,4'-DDE	0.002	0.002	0.002	0.002	0.002	0.003	0.002	0.002	0.002	0.002	0.002	0.002	0.002	0.004	0 of 38
4,4'-DDT	0.002	0.002	0.002	0.002	0.002	0.003	0.002	0.002	0.002	0.002	0.002	0.002	0.002	0.004	0 of 38
ALDRIN	0.002	0.002	0.002	0.002	0.002	0.003	0.002	0.002	0.002	0.002	0.002	0.002	0.002	0.004	0 of 38
ALPHA-BHC	0.002	0.002	0.002	0.002	0.002	0.003	0.002	0.002	0.002	0.002	0.002	0.002	0.002	0.004	0 of 38
ALPHA-CHLORDANE	0.006	0.002	0.002	0.002	0.002	0.003	0.002	0.002	0.002	0.002	0.002	0.002	0.003	0.017	1 of 38
AROCLOR-1016	0.053	0.051	0.054	0.053	0.054	0.066	0.055	0.051	0.056	0.053	0.056	0.056	0.054	0.098	0 of 38
AROCLOR-1221	0.105	0.101	0.108	0.105	0.107	0.132	0.109	0.101	0.120	0.106	0.112	0.112	0.110	0.196	0 of 38
AROCLOR-1232	0.053	0.051	0.054	0.053	0.054	0.066	0.055	0.051	0.056	0.053	0.056	0.056	0.054	0.098	0 of 38
AROCLOR-1242	0.053	0.051	0.054	0.053	0.054	0.066	0.055	0.051	0.056	0.053	0.056	0.056	0.054	0.098	0 of 38
AROCLOR-1248	0.053	0.051	0.054	0.053	0.054	0.066	0.055	0.051	0.056	0.053	0.056	0.056	0.054	0.098	0 of 38
AROCLOR-1254	0.053	0.051	0.054	0.053	0.054	0.066	0.055	0.051	0.056	0.053	0.056	0.056	0.054	0.098	0 of 38
AROCLOR-1260	0.053	0.051	0.054	0.053	0.054	0.066	0.055	0.051	0.056	0.053	0.056	0.056	0.054	0.098	0 of 38
BETA-BHC	0.002	0.002	0.002	0.002	0.002	0.003	0.002	0.002	0.002	0.002	0.002	0.002	0.002	0.004	0 of 38
CHLORDANE (TECHNICAL)	0.053	0.051	0.054	0.053	0.054	0.066	0.055	0.051	0.056	0.053	0.056	0.056	0.054	0.098	0 of 38
DELTA-BHC	0.002	0.002	0.002	0.002	0.002	0.009	0.002	0.002	0.002	0.002	0.002	0.002	0.003	0.022	1 of 38
DIELDRIN	0.002	0.002	0.002	0.002	0.002	0.003	0.002	0.002	0.002	0.002	0.002	0.002	0.002	0.004	0 of 38
ENDOSULFAN I	0.002	0.002	0.002	0.002	0.002	0.003	0.002	0.002	0.002	0.002	0.002	0.002	0.002	0.004	0 of 38
ENDOSULFAN II	0.002	0.002	0.002	0.002	0.002	0.003	0.002	0.002	0.002	0.002	0.002	0.002	0.002	0.004	0 of 38
ENDOSULFAN SULFATE	0.002	0.002	0.002	0.002	0.002	0.003	0.002	0.002	0.002	0.002	0.002	0.002	0.002	0.004	0 of 38
ENDRIN	0.002	0.002	0.002	0.002	0.002	0.003	0.002	0.002	0.002	0.002	0.002	0.002	0.002	0.004	0 of 38
ENDRIN ALDEHYDE	0.002	0.002	0.002	0.002	0.002	0.003	0.002	0.002	0.002	0.002	0.002	0.002	0.002	0.004	0 of 38
ENDRIN KETONE	0.002	0.002	0.002	0.002	0.002	0.003	0.002	0.002	0.002	0.002	0.002	0.002	0.002	0.004	0 of 38
GAMMA-BHC (LINDANE)	0.002	0.002	0.002	0.002	0.002	0.024	0.002	0.002	0.002	0.002	0.002	0.008	0.004	0.040	3 of 38
GAMMA-CHLORDANE	0.006	0.002	0.002	0.002	0.002	0.003	0.002	0.002	0.002	0.002	0.002	0.002	0.003	0.021	1 of 38
HEPTACHLOR	0.002	0.002	0.002	0.002	0.002	0.003	0.002	0.002	0.002	0.002	0.002	0.002	0.002	0.004	0 of 38
HEPTACHLOR EPOXIDE	0.002	0.002	0.002	0.002	0.002	0.003	0.002	0.002	0.002	0.002	0.002	0.002	0.002	0.004	0 of 38
METHOXYCHLOR	0.021	0.020	0.022	0.021	0.021	0.026	0.022	0.020	0.022	0.021	0.022	0.022	0.022	0.039	0 of 38
TOXAPHENE	0.053	0.051	0.054	0.053	0.054	0.066	0.055	0.051	0.056	0.053	0.056	0.056	0.054	0.098	0 of 38

Table A-4 Deer Island Influent Characterization (North System), Fiscal Year 1999, cont.

Semivolatile Organics (ug/L)	Jul	Aug	Sep	Oct	Nov	Dec	Jan	Feb	Mar	Apr	May	Jun	Average	Maximum	Times Detected
1,2,4-TRICHLOROBENZENE	1.05	1.00	1.50	1.07	2.05	1.58	1.12	1.06	1.17	1.12	1.13	1.05	1.22	4.12	0 of 38
1,2-DICHLOROBENZENE	1.05	1.00	1.50	1.07	2.05	1.58	1.12	1.06	1.17	1.12	1.13	1.05	1.22	4.12	0 of 38
1,2-DIPHENYLHYDRAZINE (AS AZOB)	1.05	1.00	1.50	1.07	2.05	1.58	1.12	1.06	1.17	1.12	1.13	1.05	1.22	4.12	0 of 38
1,3-DICHLOROBENZENE	1.05	1.00	1.50	1.07	2.05	1.58	1.12	1.06	1.17	1.12	1.13	1.05	1.22	4.12	0 of 38
1,4-DICHLOROBENZENE	1.05	1.00	1.50	1.07	2.05	1.58	1.12	1.06	1.17	1.12	1.13	1.05	1.22	4.12	0 of 38
2,2'-OXYBIS(1-CHLOROPROPANE)	1.05	1.00	1.50	1.07	2.05	1.58	1.12	1.06	1.17	1.12	1.13	1.05	1.22	4.12	0 of 38
2,4,5-TRICHLOROPHENOL	1.05	1.00	1.50	1.07	2.05	1.58	1.12	1.06	1.17	1.12	1.13	1.05	1.22	4.12	0 of 38
2,4,6-TRICHLOROPHENOL	1.05	1.00	1.50	1.07	2.05	1.58	1.12	1.06	1.17	1.12	1.13	1.05	1.22	4.12	0 of 38
2,4-DICHLOROPHENOL	1.05	1.00	1.50	1.07	2.05	1.58	1.12	1.06	1.17	1.12	1.13	1.05	1.22	4.12	0 of 38
2,4-DIMETHYLPHENOL	1.05	1.00	1.50	1.07	2.05	1.58	1.12	1.06	1.17	1.12	1.13	1.05	1.22	4.12	0 of 38
2,4-DINITROPHENOL	2.10	2.01	3.01	2.14	4.11	3.16	2.24	2.11	2.35	2.24	2.26	2.09	2.44	8.24	0 of 38
2,4-DINITROTOLUENE	1.05	1.00	1.50	1.07	2.05	1.58	1.12	1.06	1.17	1.12	1.13	1.05	1.22	4.12	0 of 38
2,6-DINITROTOLUENE	1.05	1.00	1.50	1.07	2.05	1.58	1.12	1.06	1.17	1.12	1.13	1.05	1.22	4.12	0 of 38
2-CHLORONAPHTHALENE	1.05	1.00	1.50	1.07	2.05	1.58	1.12	1.06	1.17	1.12	1.13	1.05	1.22	4.12	0 of 38
2-CHLOROPHENOL	1.05	1.00	1.50	1.07	2.05	1.58	1.12	1.06	1.17	1.12	1.13	1.05	1.22	4.12	0 of 38
2-METHYL-4,6-DINITROPHENOL	10.52	10.03	15.04	10.70	20.53	15.78	11.18	10.56	11.75	11.20	11.32	10.47	12.18	41.20	0 of 38
2-METHYLNAPHTHALENE	1.05	1.00	1.50	1.07	2.05	1.58	1.12	1.06	1.17	1.12	1.13	1.05	1.22	4.12	0 of 38
2-METHYLPHENOL	1.05	1.00	1.50	1.07	2.05	1.58	1.12	1.06	1.17	1.12	1.13	1.05	1.22	4.12	0 of 38
2-NITROANILINE	1.05	1.00	1.50	1.07	2.05	1.58	1.12	1.06	1.17	1.12	1.13	1.05	1.22	4.12	0 of 38
2-NITROPHENOL	1.05	1.00	1.50	1.07	2.05	1.58	1.12	1.06	1.17	1.12	1.13	1.05	1.22	4.12	0 of 38
3,3'-DICHLOROBENZIDINE	2.10	2.01	3.01	2.14	4.11	3.16	2.24	2.11	2.35	2.24	2.26	2.09	2.44	8.24	0 of 38
3-NITROANILINE	1.05	1.00	1.50	1.07	2.05	1.58	1.12	1.06	1.17	1.12	1.13	1.05	1.22	4.12	0 of 38
4-BROMOPHENYL PHENYL ETHER	1.05	1.00	1.50	1.07	2.05	1.58	1.12	1.06	1.17	1.12	1.13	1.05	1.22	4.12	0 of 38
4-CHLORO-3-METHYLPHENOL	1.05	1.00	1.50	1.07	2.05	1.58	1.12	1.06	1.17	1.12	1.13	1.05	1.22	4.12	0 of 38
4-CHLOROANILINE	1.05	1.00	1.50	1.07	2.05	1.58	1.12	1.06	1.17	1.12	1.13	1.05	1.22	4.12	0 of 38
4-CHLOROPHENYL PHENYL ETHER	1.05	1.00	1.50	1.07	2.05	1.58	1.12	1.06	1.17	1.12	1.13	1.05	1.22	4.12	0 of 38
4-METHYLPHENOL (INCLUDES 3-MET)	3.42	15.00	14.45	13.63	29.73	30.49	21.08	19.38	7.26	20.74	12.09	21.80	16.42	36.60	33 of 38
4-NITROANILINE	1.05	1.00	1.50	1.07	2.05	1.58	1.12	1.06	1.17	1.12	1.13	1.05	1.22	4.12	0 of 38
4-NITROPHENOL	2.10	2.01	3.01	2.14	4.11	3.16	2.24	2.11	2.35	2.24	2.26	2.09	2.44	8.24	0 of 38
ACENAPHTHENE	1.05	1.00	1.50	1.07	2.05	1.58	1.12	1.06	1.17	1.12	1.13	1.05	1.22	4.12	0 of 38
ACENAPHTHYLENE	1.05	1.00	1.50	1.07	2.05	1.58	1.12	1.06	1.17	1.12	1.13	1.05	1.22	4.12	0 of 38
ANILINE	1.05	1.00	1.50	1.07	2.05	1.58	1.12	1.06	1.17	1.12	1.13	1.05	1.22	4.12	0 of 38
ANTHRACENE	1.05	1.00	1.50	1.07	2.05	1.58	1.12	1.06	1.17	1.12	1.13	1.05	1.22	4.12	0 of 38
BENZIDINE	5.26	5.02	7.52	5.35	10.27	7.89	5.59	5.28	5.87	5.60	5.66	5.23	6.09	20.60	0 of 38
BENZO(A)ANTHRACENE	1.05	1.00	1.50	1.07	2.05	1.58	1.12	1.06	1.17	1.12	1.13	1.05	1.22	4.12	0 of 38

Table A-4 Deer Island Influent Characterization (North System), Fiscal Year 1999, cont.

Semivolatile Organics (ug/L)															Times
	Jul	Aug	Sep	Oct	Nov	Dec	Jan	Feb	Mar	Apr	May	Jun	Average	Maximum	Detected
BENZO(A)PYRENE	1.05	1.00	1.50	1.07	2.05	1.58	1.12	1.06	1.17	1.12	1.13	1.05	1.22	4.12	0 of 38
BENZO(B)FLUORANTHENE	1.05	1.00	1.50	1.07	2.05	1.58	1.12	1.06	1.17	1.12	1.13	1.05	1.22	4.12	0 of 38
BENZO(GH)PERYLENE	1.05	1.00	1.50	1.07	2.05	1.58	1.12	1.06	1.17	1.12	1.13	1.05	1.22	4.12	0 of 38
BENZO(K)FLUORANTHENE	1.05	1.00	1.50	1.07	2.05	1.58	1.12	1.06	1.17	1.12	1.13	1.05	1.22	4.12	0 of 38
BENZOIC ACID	2.10	6.59	16.21	5.21	19.61	35.61	9.73	2.11	6.43	2.24	11.45	2.09	9.26	63.76	15 of 38
BENZYL ALCOHOL	4.17	6.64	5.12	8.97	5.41	10.41	7.98	3.09	19.44	5.94	6.54	7.16	7.62	31.20	25 of 38
BIS(2-CHLOROETHOXY)METHANE	1.05	1.00	1.50	1.07	2.05	1.58	1.12	1.06	1.17	1.12	1.13	1.05	1.22	4.12	0 of 38
BIS(2-CHLOROETHYL)ETHER	1.05	1.00	1.50	1.07	2.05	1.58	1.12	1.06	1.17	1.12	1.13	1.05	1.22	4.12	0 of 38
BIS(2-ETHYLHEXYL)PHTHALATE	1.05	1.00	10.04	6.64	6.31	11.38	9.77	5.88	1.17	10.61	5.22	8.16	6.12	19.11	25 of 38
BUTYL BENZYL PHTHALATE	1.05	1.00	1.50	1.07	2.05	1.58	1.12	1.06	1.17	2.98	1.13	1.05	1.36	6.56	1 of 38
CHRYSENE	1.05	1.00	1.50	1.07	2.05	1.58	1.12	1.06	1.17	1.12	1.13	1.05	1.22	4.12	0 of 38
DIBENZO(A,H)ANTHRACENE	1.05	1.00	1.50	1.07	2.05	1.58	1.12	1.06	1.17	1.12	1.13	1.05	1.22	4.12	0 of 38
DIBENZOFURAN	1.05	1.00	1.50	1.07	2.05	1.58	1.12	1.06	1.17	1.12	1.13	1.05	1.22	4.12	0 of 38
DIETHYL PHTHALATE	1.05	1.00	1.50	2.51	2.05	1.58	1.12	1.06	1.17	1.12	1.13	1.05	1.35	7.63	1 of 38
DIMETHYL PHTHALATE	1.05	1.00	1.50	1.07	2.05	1.58	1.12	1.06	1.17	1.12	1.13	1.05	1.22	4.12	0 of 38
DI-N-BUTYLPHTHALATE	1.05	1.00	4.15	1.07	2.05	1.58	3.59	1.06	1.17	2.61	1.13	2.59	1.84	6.31	6 of 38
DI-N-OCTYLPHTHALATE	1.05	1.00	1.50	1.07	2.05	1.58	1.12	1.06	1.17	1.12	1.13	1.05	1.22	4.12	0 of 38
FLUORANTHENE	1.05	1.00	1.50	1.07	2.05	1.58	1.12	1.06	1.17	1.12	1.13	1.05	1.22	4.12	0 of 38
FLUORENE	1.05	1.00	1.50	1.07	2.05	1.58	1.12	1.06	1.17	1.12	1.13	1.05	1.22	4.12	0 of 38
HEXACHLOROBENZENE	1.05	1.00	1.50	1.07	2.05	1.58	1.12	1.06	1.17	1.12	1.13	1.05	1.22	4.12	0 of 38
HEXACHLOROBUTADIENE	1.05	1.00	1.50	1.07	2.05	1.58	1.12	1.06	1.17	1.12	1.13	1.05	1.22	4.12	0 of 38
HEXACHLOROCYCLOPENTADIENE	5.26	5.02	7.52	5.35	10.27	7.89	5.59	5.28	5.87	5.60	5.66	5.23	6.09	20.60	0 of 38
HEXACHLOROETHANE	1.05	1.00	1.50	1.07	2.05	1.58	1.12	1.06	1.17	1.12	1.13	1.05	1.22	4.12	0 of 38
INDENO(1,2,3-CD)PYRENE	1.05	1.00	1.50	1.07	2.05	1.58	1.12	1.06	1.17	1.12	1.13	1.05	1.22	4.12	0 of 38
ISOPHORONE	1.05	1.00	1.50	1.07	2.05	1.58	1.12	1.06	1.17	1.12	1.13	1.05	1.22	4.12	0 of 38
NAPHTHALENE	1.05	1.00	1.50	1.07	2.05	1.58	1.12	1.06	1.17	1.12	1.13	1.05	1.22	4.12	0 of 38
NITROBENZENE	1.05	1.00	1.50	1.07	2.05	1.58	1.12	1.06	1.17	1.12	1.13	1.05	1.22	4.12	0 of 38
N-NITROSODIMETHYLAMINE	1.05	1.00	1.50	1.07	2.05	1.58	1.12	1.06	1.17	1.12	1.13	1.05	1.22	4.12	0 of 38
N-NITROSODI-N-PROPYLAMINE	1.05	1.00	1.50	1.07	2.05	1.58	1.12	1.06	1.17	1.12	1.13	1.05	1.22	4.12	0 of 38
N-NITROSODIPHENYLAMINE	1.05	1.00	1.50	1.07	2.05	1.58	1.12	1.06	1.17	1.12	1.13	1.05	1.22	4.12	0 of 38
PENTACHLOROPHENOL	5.26	5.02	7.52	3.74	6.16	4.73	3.35	3.17	3.52	3.36	3.40	3.14	4.30	12.36	0 of 38
PHENANTHRENE	0.33	0.10	0.15	0.11	0.21	0.16	0.11	0.11	0.12	0.11	0.11	0.10	0.15	1.09	0 of 38
PHENOL	2.10	2.01	3.01	2.14	4.11	6.93	2.24	2.11	2.35	2.24	2.26	2.09	2.70	8.24	2 of 38
PYRENE	1.05	1.00	1.50	1.07	2.05	1.58	1.12	1.06	1.17	1.12	1.13	1.05	1.22	4.12	0 of 38

Table A-4 Deer Island Influent Characterization (North System), Fiscal Year 1999, cont.

Volatile Organics (ug/L)															Times	
	Jul	Aug	Sep	Oct	Nov	Dec	Jan	Feb	Mar	Apr	May	Jun	Average	Maximum	Detected	
1,1,1-TRICHLOROETHANE	0.50	0.50	0.50	0.50	0.50	0.50	0.50	0.50	0.50	0.50	0.50	0.50	0.50	0.50	0.50	0 of 36
1,1,2,2-TETRACHLOROETHANE	0.50	0.50	0.50	0.50	0.50	0.50	0.50	0.50	0.50	0.50	0.50	0.50	0.50	0.50	0.50	0 of 36
1,1,2-TRICHLOROETHANE	0.50	0.50	0.50	0.50	0.50	0.50	0.50	0.50	0.50	0.50	0.50	0.50	0.50	0.50	0.50	0 of 36
1,1-DICHLOROETHANE	0.50	0.50	0.50	0.50	0.50	0.50	0.50	0.50	0.50	0.50	0.50	0.50	0.50	0.50	0.50	0 of 36
1,1-DICHLOROETHENE	0.50	0.50	0.50	0.50	0.50	0.50	0.50	0.50	0.50	1.26	0.50	0.50	0.56	2.79	1 of 36	
1,2-DICHLOROBENZENE	0.50	0.50	0.50	0.50	0.50	0.50	0.50	0.50	0.50	0.50	0.50	0.50	0.50	0.50	0.50	0 of 36
1,2-DICHLOROETHANE	0.50	0.50	0.50	0.50	0.50	0.50	0.50	0.50	0.50	0.50	0.50	0.50	0.50	0.50	0.50	0 of 36
1,2-DICHLOROPROPANE	0.50	0.50	0.50	0.50	0.50	0.50	0.50	0.50	0.50	0.50	0.50	0.50	0.50	0.50	0.50	0 of 36
1,3-DICHLOROBENZENE	0.50	0.50	0.50	0.50	0.50	0.50	0.50	0.50	0.50	0.50	0.50	0.50	0.50	0.50	0.50	0 of 36
1,4-DICHLOROBENZENE	0.50	0.50	0.50	0.50	0.50	0.50	0.50	0.50	1.18	0.50	0.50	1.20	0.62	2.65	2 of 36	
2-BUTANONE	0.50	0.50	6.28	2.09	2.32	3.87	0.50	1.73	1.80	5.27	4.03	2.50	2.60	8.30	15 of 36	
2-CHLOROETHYL VINYL ETHER	0.50	0.50	0.50	0.50	0.50	0.50	0.50	0.50	0.50	0.50	0.50	0.50	0.50	0.50	0.50	0 of 36
2-HEXANONE	0.50	0.50	0.50	0.50	0.50	0.50	0.50	0.50	0.50	0.50	0.50	0.50	0.50	0.50	0.50	0 of 36
4-METHYL-2-PENTANONE	0.50	0.50	0.50	0.50	0.50	0.50	0.50	0.50	0.50	0.50	0.50	0.50	0.50	0.50	0.50	0 of 36
ACETONE	135.71	168.00	165.23	175.70	121.43	102.95	147.97	101.11	157.09	121.89	114.13	115.54	133.83	309.00	36 of 36	
ACROLEIN	0.50	0.50	0.50	0.50	0.50	0.50	0.50	0.50	0.50	0.50	0.50	0.50	0.50	0.50	0.50	0 of 36
ACRYLONITRILE	0.50	0.50	0.50	0.50	0.50	0.50	0.50	0.50	0.50	0.50	0.50	0.50	0.50	0.50	0.50	0 of 36
BENZENE	0.50	0.50	0.50	0.50	0.50	0.50	0.50	0.50	0.50	0.50	0.50	0.50	0.50	0.50	0.50	0 of 36
BROMODICHLOROMETHANE	0.50	0.50	0.50	0.50	0.50	0.50	1.58	0.50	0.50	0.50	0.50	0.50	0.59	3.91	1 of 36	
BROMOFORM	0.50	0.50	0.50	0.50	0.50	0.50	0.50	0.50	0.50	0.50	0.50	0.50	0.50	0.50	0.50	0 of 36
BROMOMETHANE	0.50	0.50	0.50	0.50	0.50	0.50	0.50	0.50	0.50	0.50	0.50	0.50	0.50	0.50	0.50	0 of 36
CARBON DISULFIDE	2.21	0.50	4.55	0.50	7.36	1.72	1.28	1.26	0.50	3.26	0.50	1.79	2.06	15.40	11 of 36	
CARBON TETRACHLORIDE	0.50	0.50	0.50	0.50	0.50	0.50	0.50	0.50	0.50	0.50	0.50	0.50	0.50	0.50	0.50	0 of 36
CHLOROBENZENE	0.50	0.50	0.50	0.50	0.50	0.50	0.50	0.50	0.50	0.50	0.50	0.50	0.50	0.50	0.50	0 of 36
CHLOROETHANE	0.50	0.50	0.50	0.50	0.50	0.50	0.50	0.50	0.50	0.50	0.50	0.50	0.50	0.50	0.50	0 of 36
CHLOROFORM	7.71	6.58	7.95	7.24	7.80	7.48	7.63	4.88	6.72	8.19	10.48	9.71	7.72	13.00	36 of 36	
CHLOROMETHANE	0.50	0.50	0.50	0.50	0.50	0.50	0.50	0.50	0.50	0.50	1.68	0.50	0.62	5.49	1 of 36	
CIS-1,2-DICHLOROETHENE	0.50	0.50	0.50	0.50	0.50	0.50	1.16	0.50	1.19	0.50	0.50	0.50	0.62	2.65	2 of 36	
CIS-1,3-DICHLOROPROPENE	0.50	0.50	0.50	0.50	0.50	0.50	0.50	0.50	0.50	0.50	0.50	0.50	0.50	0.50	0.50	0 of 36
DIBROMOCHLOROMETHANE	0.50	0.50	0.50	0.50	0.50	0.50	0.50	0.50	0.50	0.50	0.50	0.50	0.50	0.50	0.50	0 of 36
ETHYLBENZENE	0.50	0.50	0.50	0.50	0.50	0.50	0.50	0.50	0.50	0.50	0.50	0.50	0.50	0.50	0.50	0 of 36
M,P-XYLENE	0.50	0.50	0.50	0.50	0.50	0.50	0.50	0.50	1.20	0.50	0.50	0.50	0.57	2.58	1 of 36	
METHYLENE CHLORIDE	2.72	9.88	2.48	2.14	7.92	3.66	0.50	3.75	3.87	6.40	2.87	5.87	3.87	12.30	24 of 36	
O-XYLENE	0.50	0.50	0.50	0.50	0.50	0.50	0.50	0.50	0.50	0.50	0.50	0.50	0.50	0.50	0.50	0 of 36

Table A-4 Deer Island Influent Characterization (North System), Fiscal Year 1999, cont.

Volatile Organics (ug/L)															Times	
	Jul	Aug	Sep	Oct	Nov	Dec	Jan	Feb	Mar	Apr	May	Jun	Average	Maximum	Detected	
STYRENE	0.50	0.50	0.50	0.50	0.50	0.50	0.50	0.50	0.50	0.50	0.50	0.50	0.50	0.50	0.50	0 of 36
TETRACHLOROETHENE	1.74	0.50	2.84	3.26	0.50	1.19	2.88	2.11	7.11	3.08	2.36	9.97	3.23	26.89	19 of 36	
TOLUENE	5.22	4.56	5.27	4.38	5.07	6.50	3.30	2.12	2.90	3.88	5.83	5.32	4.45	9.14	33 of 36	
TRANS-1,2-DICHLOROETHENE	0.50	0.50	0.50	0.50	0.50	0.50	0.50	0.50	0.50	0.50	0.50	0.50	0.50	0.50	0 of 36	
TRANS-1,3-DICHLOROPROPENE	0.50	0.50	0.50	0.50	0.50	0.50	0.50	0.50	0.50	0.50	0.50	0.50	0.50	0.50	0 of 36	
TRICHLOROETHENE	0.50	0.50	1.66	2.21	0.50	1.17	0.50	0.50	1.22	1.20	0.50	1.39	0.98	7.33	6 of 36	
TRICHLOROFLUOROMETHANE	0.50	0.50	0.50	3.54	0.50	0.50	0.50	0.50	0.50	0.50	0.50	0.50	0.78	6.61	1 of 36	
VINYL ACETATE	0.50	0.50	0.50	0.50	0.50	0.50	0.50	0.50	0.50	0.50	0.50	0.50	0.50	0.50	0 of 36	
VINYL CHLORIDE	0.50	0.50	0.50	0.50	0.50	0.50	0.50	0.50	0.50	0.50	0.50	0.50	0.50	0.50	0 of 36	

Notes:

Results in *bold italics* indicate one or more detects in the month.

Yearly averages are calculated from individual results collected in the fiscal year.

Non-detected compounds are assumed to equal one half of the detection limit for metals and inorganics and one tenth of the reporting limit for organic compounds.

Table A-5 Deer Island Influent Loadings (North System), Fiscal Year 1999

Metals (lbs/day)													Times		
	Jul	Aug	Sep	Oct	Nov	Dec	Jan	Feb	Mar	Apr	May	Jun	Average	Maximum	Detected
ANTIMONY	40.06	37.63	33.15	41.85	18.63	14.31	20.94	24.96	28.69	13.26	13.90	11.41	25.19	73.55	0 of 79
ARSENIC	2.40	3.21	1.34	2.13	1.73	3.19	4.01	1.30	2.63	1.49	3.04	1.87	2.37	12.03	49 of 79
BERYLLIUM	1.00	0.94	0.83	1.05	0.55	0.40	0.60	0.63	0.61	0.44	0.46	0.48	0.67	1.84	1 of 79
BORON	411.12	308.22	405.56	592.05	519.00	356.96	437.69	325.66	350.50	409.16	421.67	389.61	412.39	1169.46	46 of 79
CADMIUM	3.08	1.88	1.66	2.09	2.52	1.61	2.41	2.14	2.45	1.77	1.85	1.52	2.11	5.60	5 of 79
CHROMIUM	9.54	6.39	6.98	7.52	7.90	10.37	13.58	11.95	28.09	11.17	14.19	6.16	11.23	88.55	55 of 79
COPPER	176.53	131.25	121.76	140.69	101.91	137.72	170.19	99.94	123.07	111.63	142.64	116.37	131.31	403.26	79 of 79
HEXAVALENT CHROMIUM	10.70	9.21	8.69	11.28	9.10	8.45	9.99	12.42	12.19	10.00	9.41	8.48	10.04	16.83	0 of 36
IRON	4501.05	4226.53	2912.59	3685.07	2187.62	2803.14	5920.35	2568.03	3979.62	2841.11	4303.45	2978.82	3605.82	12227.91	80 of 80
LEAD	46.04	60.32	34.00	41.30	18.81	20.17	51.87	12.10	30.95	28.10	54.01	18.64	35.35	239.38	78 of 79
MERCURY	0.55	0.56	0.50	0.49	0.42	0.72	0.92	0.27	0.41	0.45	0.58	0.38	0.52	2.09	79 of 80
MOLYBDENUM	16.48	25.47	17.73	30.44	16.40	13.11	17.15	8.05	14.20	12.39	23.31	13.63	17.64	80.54	78 of 85
NICKEL	15.11	11.39	6.63	11.61	7.97	8.28	15.89	7.33	11.14	8.25	16.50	11.34	11.05	42.69	49 of 79
SELENIUM	1.36	0.95	1.70	1.05	1.23	0.73	1.08	0.96	1.09	0.93	0.83	1.03	1.09	7.43	5 of 79
SILVER	5.77	4.81	5.27	9.46	7.09	8.99	7.43	6.47	10.25	9.14	9.10	7.35	7.53	18.94	68 of 79
THALLIUM	1.00	0.94	1.89	1.49	0.80	0.81	1.20	1.07	1.23	0.88	0.93	0.76	1.09	8.25	1 of 79
ZINC	245.23	221.61	170.38	197.84	142.04	191.36	290.52	160.37	256.00	212.87	264.04	183.60	212.10	666.68	80 of 80
Cyanide and Phenols (lbs/day)															
	Jul	Aug	Sep	Oct	Nov	Dec	Jan	Feb	Mar	Apr	May	Jun	Average	Maximum	Times Detected
CYANIDE	9.73	8.37	7.90	10.26	8.27	7.68	13.98	11.29	11.08	9.09	8.56	7.71	9.54	23.37	1 of 36
TOTAL PHENOLS	24.67	60.33	41.20	89.65	75.89	67.77	81.01	42.33	21.02	57.77	45.37	49.53	53.68	137.24	35 of 38
Oil and Grease, Petroleum Hydrocarbons, and Surfactants (lbs/day)															
	Jul	Aug	Sep	Oct	Nov	Dec	Jan	Feb	Mar	Apr	May	Jun	Average	Maximum	Times Detected
PETROLEUM HYDROCARBON	1381	1021	1301	1560	1276	1099	1972	1417	1934	1447	1000	1829	1446	2597	36 of 36
TOTAL PETROLEUM HYDROCARBON	4583	2846	3538	4206	4412	4736	12842	12912	6862	10560	3667	10011	6836	21545	36 of 36
FATS OIL AND GREASE	52977	64422	57314	81627	66014	58289	63858	63452	74494	88266	78028	70512	68598	178925	73 of 73
MBAS	8225	6676	7432	7723	6639	8792	9356	7600	5210	8030	6854	7075	7471	13236	38 of 38

Table A-5 Deer Island Influent Loadings (North System), Fiscal Year 1999, cont.

Organochlorine Pesticides and PCBs (lbs/day)	Jul	Aug	Sep	Oct	Nov	Dec	Jan	Feb	Mar	Apr	May	Jun	Average	Maximum	Times Detected
4,4'-DDD	0.004	0.003	0.004	0.005	0.004	0.004	0.005	0.005	0.005	0.004	0.004	0.003	0.004	0.007	0 of 38
4,4'-DDE	0.004	0.003	0.004	0.005	0.004	0.004	0.005	0.005	0.005	0.004	0.004	0.003	0.004	0.007	0 of 38
4,4'-DDT	0.004	0.003	0.004	0.005	0.004	0.004	0.005	0.005	0.005	0.004	0.004	0.003	0.004	0.007	0 of 38
ALDRIN	0.004	0.003	0.004	0.005	0.004	0.004	0.005	0.005	0.005	0.004	0.004	0.003	0.004	0.007	0 of 38
ALPHA-BHC	0.004	0.003	0.004	0.005	0.004	0.004	0.005	0.005	0.005	0.004	0.004	0.003	0.004	0.007	0 of 38
ALPHA-CHLORDANE	0.012	0.003	0.004	0.005	0.004	0.004	0.005	0.005	0.005	0.004	0.004	0.003	0.005	0.033	1 of 38
AROCLOR-1016	0.110	0.085	0.093	0.118	0.089	0.112	0.122	0.114	0.128	0.098	0.097	0.085	0.104	0.184	0 of 38
AROCLOR-1221	0.220	0.169	0.185	0.237	0.178	0.224	0.245	0.229	0.276	0.195	0.193	0.169	0.210	0.368	0 of 38
AROCLOR-1232	0.110	0.085	0.093	0.118	0.089	0.112	0.122	0.114	0.128	0.098	0.097	0.085	0.104	0.184	0 of 38
AROCLOR-1242	0.110	0.085	0.093	0.118	0.089	0.112	0.122	0.114	0.128	0.098	0.097	0.085	0.104	0.184	0 of 38
AROCLOR-1248	0.110	0.085	0.093	0.118	0.089	0.112	0.122	0.114	0.128	0.098	0.097	0.085	0.104	0.184	0 of 38
AROCLOR-1254	0.110	0.085	0.093	0.118	0.089	0.112	0.122	0.114	0.128	0.098	0.097	0.085	0.104	0.184	0 of 38
AROCLOR-1260	0.110	0.085	0.093	0.118	0.089	0.112	0.122	0.114	0.128	0.098	0.097	0.085	0.104	0.184	0 of 38
BETA-BHC	0.004	0.003	0.004	0.005	0.004	0.004	0.005	0.005	0.005	0.004	0.004	0.003	0.004	0.007	0 of 38
CHLORDANE (TECHNICAL)	0.110	0.085	0.093	0.118	0.089	0.112	0.122	0.114	0.128	0.098	0.097	0.085	0.104	0.184	0 of 38
DELTA-BHC	0.004	0.003	0.004	0.005	0.004	0.015	0.005	0.005	0.005	0.004	0.004	0.003	0.005	0.034	1 of 38
DIELDRIN	0.004	0.003	0.004	0.005	0.004	0.004	0.005	0.005	0.005	0.004	0.004	0.003	0.004	0.007	0 of 38
ENDOSULFAN I	0.004	0.003	0.004	0.005	0.004	0.004	0.005	0.005	0.005	0.004	0.004	0.003	0.004	0.007	0 of 38
ENDOSULFAN II	0.004	0.003	0.004	0.005	0.004	0.004	0.005	0.005	0.005	0.004	0.004	0.003	0.004	0.007	0 of 38
ENDOSULFAN SULFATE	0.004	0.003	0.004	0.005	0.004	0.004	0.005	0.005	0.005	0.004	0.004	0.003	0.004	0.007	0 of 38
ENDRIN	0.004	0.003	0.004	0.005	0.004	0.004	0.005	0.005	0.005	0.004	0.004	0.003	0.004	0.007	0 of 38
ENDRIN ALDEHYDE	0.004	0.003	0.004	0.005	0.004	0.004	0.005	0.005	0.005	0.004	0.004	0.003	0.004	0.007	0 of 38
ENDRIN KETONE	0.004	0.003	0.004	0.005	0.004	0.004	0.005	0.005	0.005	0.004	0.004	0.003	0.004	0.007	0 of 38
GAMMA-BHC (LINDANE)	0.004	0.003	0.004	0.005	0.004	0.040	0.005	0.005	0.005	0.004	0.004	0.012	0.008	0.082	3 of 38
GAMMA-CHLORDANE	0.013	0.003	0.004	0.005	0.004	0.004	0.005	0.005	0.005	0.004	0.004	0.003	0.005	0.040	1 of 38
HEPTACHLOR	0.004	0.003	0.004	0.005	0.004	0.004	0.005	0.005	0.005	0.004	0.004	0.003	0.004	0.007	0 of 38
HEPTACHLOR EPOXIDE	0.004	0.003	0.004	0.005	0.004	0.004	0.005	0.005	0.005	0.004	0.004	0.003	0.004	0.007	0 of 38
METHOXYCHLOR	0.044	0.034	0.037	0.047	0.036	0.045	0.049	0.046	0.051	0.039	0.039	0.034	0.042	0.074	0 of 38
TOXAPHENE	0.110	0.085	0.093	0.118	0.089	0.112	0.122	0.114	0.128	0.098	0.097	0.085	0.104	0.184	0 of 38

Table A-5 Deer Island Influent Loadings (North System), Fiscal Year 1999, cont.

Semivolatile Organics (lbs/day)	Jul	Aug	Sep	Oct	Nov	Dec	Jan	Feb	Mar	Apr	May	Jun	Average	Maximum	Times Detected
1,2,4-TRICHLOROBENZENE	2.21	1.68	2.58	2.41	3.41	2.68	2.50	2.38	2.69	2.06	1.95	1.59	2.33	6.80	0 of 38
1,2-DICHLOROBENZENE	2.21	1.68	2.58	2.41	3.41	2.68	2.50	2.38	2.69	2.06	1.95	1.59	2.33	6.80	0 of 38
1,2-DIPHENYLHYDRAZINE (AS AZOB)	2.21	1.68	2.58	2.41	3.41	2.68	2.50	2.38	2.69	2.06	1.95	1.59	2.33	6.80	0 of 38
1,3-DICHLOROBENZENE	2.21	1.68	2.58	2.41	3.41	2.68	2.50	2.38	2.69	2.06	1.95	1.59	2.33	6.80	0 of 38
1,4-DICHLOROBENZENE	2.21	1.68	2.58	2.41	3.41	2.68	2.50	2.38	2.69	2.06	1.95	1.59	2.33	6.80	0 of 38
2,2'-OXYBIS(1-CHLOROPROPANE)	2.21	1.68	2.58	2.41	3.41	2.68	2.50	2.38	2.69	2.06	1.95	1.59	2.33	6.80	0 of 38
2,4,5-TRICHLOROPHENOL	2.21	1.68	2.58	2.41	3.41	2.68	2.50	2.38	2.69	2.06	1.95	1.59	2.33	6.80	0 of 38
2,4,6-TRICHLOROPHENOL	2.21	1.68	2.58	2.41	3.41	2.68	2.50	2.38	2.69	2.06	1.95	1.59	2.33	6.80	0 of 38
2,4-DICHLOROPHENOL	2.21	1.68	2.58	2.41	3.41	2.68	2.50	2.38	2.69	2.06	1.95	1.59	2.33	6.80	0 of 38
2,4-DIMETHYLPHENOL	2.21	1.68	2.58	2.41	3.41	2.68	2.50	2.38	2.69	2.06	1.95	1.59	2.33	6.80	0 of 38
2,4-DINITROPHENOL	4.41	3.36	5.17	4.81	6.82	5.36	5.01	4.77	5.38	4.12	3.89	3.18	4.66	13.59	0 of 38
2,4-DINITROTOLUENE	2.21	1.68	2.58	2.41	3.41	2.68	2.50	2.38	2.69	2.06	1.95	1.59	2.33	6.80	0 of 38
2,6-DINITROTOLUENE	2.21	1.68	2.58	2.41	3.41	2.68	2.50	2.38	2.69	2.06	1.95	1.59	2.33	6.80	0 of 38
2-CHLORONAPHTHALENE	2.21	1.68	2.58	2.41	3.41	2.68	2.50	2.38	2.69	2.06	1.95	1.59	2.33	6.80	0 of 38
2-CHLOROPHENOL	2.21	1.68	2.58	2.41	3.41	2.68	2.50	2.38	2.69	2.06	1.95	1.59	2.33	6.80	0 of 38
2-METHYL-4,6-DINITROPHENOL	22.06	16.80	25.83	24.07	34.10	26.78	25.04	23.85	26.92	20.59	19.47	15.88	23.31	67.96	0 of 38
2-METHYLNAPHTHALENE	2.21	1.68	2.58	2.41	3.41	2.68	2.50	2.38	2.69	2.06	1.95	1.59	2.33	6.80	0 of 38
2-METHYLPHENOL	2.21	1.68	2.58	2.41	3.41	2.68	2.50	2.38	2.69	2.06	1.95	1.59	2.33	6.80	0 of 38
2-NITROANILINE	2.21	1.68	2.58	2.41	3.41	2.68	2.50	2.38	2.69	2.06	1.95	1.59	2.33	6.80	0 of 38
2-NITROPHENOL	2.21	1.68	2.58	2.41	3.41	2.68	2.50	2.38	2.69	2.06	1.95	1.59	2.33	6.80	0 of 38
3,3'-DICHLOROBENZIDINE	4.41	3.36	5.17	4.81	6.82	5.36	5.01	4.77	5.38	4.12	3.89	3.18	4.66	13.59	0 of 38
3-NITROANILINE	2.21	1.68	2.58	2.41	3.41	2.68	2.50	2.38	2.69	2.06	1.95	1.59	2.33	6.80	0 of 38
4-BROMOPHENYL PHENYL ETHER	2.21	1.68	2.58	2.41	3.41	2.68	2.50	2.38	2.69	2.06	1.95	1.59	2.33	6.80	0 of 38
4-CHLORO-3-METHYLPHENOL	2.21	1.68	2.58	2.41	3.41	2.68	2.50	2.38	2.69	2.06	1.95	1.59	2.33	6.80	0 of 38
4-CHLOROANILINE	2.21	1.68	2.58	2.41	3.41	2.68	2.50	2.38	2.69	2.06	1.95	1.59	2.33	6.80	0 of 38
4-CHLOROPHENYL PHENYL ETHER	2.21	1.68	2.58	2.41	3.41	2.68	2.50	2.38	2.69	2.06	1.95	1.59	2.33	6.80	0 of 38
4-METHYLPHENOL (INCLUDES 3-MET)	7.17	25.11	24.82	30.67	49.38	51.76	47.22	43.78	16.63	38.12	20.79	33.08	31.41	77.32	33 of 38
4-NITROANILINE	2.21	1.68	2.58	2.41	3.41	2.68	2.50	2.38	2.69	2.06	1.95	1.59	2.33	6.80	0 of 38
4-NITROPHENOL	4.41	3.36	5.17	4.81	6.82	5.36	5.01	4.77	5.38	4.12	3.89	3.18	4.66	13.59	0 of 38
ACENAPHTHENE	2.21	1.68	2.58	2.41	3.41	2.68	2.50	2.38	2.69	2.06	1.95	1.59	2.33	6.80	0 of 38
ACENAPHTHYLENE	2.21	1.68	2.58	2.41	3.41	2.68	2.50	2.38	2.69	2.06	1.95	1.59	2.33	6.80	0 of 38
ANILINE	2.21	1.68	2.58	2.41	3.41	2.68	2.50	2.38	2.69	2.06	1.95	1.59	2.33	6.80	0 of 38
ANTHRACENE	2.21	1.68	2.58	2.41	3.41	2.68	2.50	2.38	2.69	2.06	1.95	1.59	2.33	6.80	0 of 38
BENZIDINE	11.03	8.40	12.91	12.03	17.05	13.39	12.52	11.92	13.46	10.29	9.73	7.94	11.65	33.98	0 of 38
BENZO(A)ANTHRACENE	2.21	1.68	2.58	2.41	3.41	2.68	2.50	2.38	2.69	2.06	1.95	1.59	2.33	6.80	0 of 38

Table A-5 Deer Island Influent Loadings (North System), Fiscal Year 1999, cont.

Semivolatile Organics (lbs/day)	Jul	Aug	Sep	Oct	Nov	Dec	Jan	Feb	Mar	Apr	May	Jun	Average	Maximum	Times Detected
BENZO(A)PYRENE	2.21	1.68	2.58	2.41	3.41	2.68	2.50	2.38	2.69	2.06	1.95	1.59	2.33	6.80	0 of 38
BENZO(B)FLUORANTHENE	2.21	1.68	2.58	2.41	3.41	2.68	2.50	2.38	2.69	2.06	1.95	1.59	2.33	6.80	0 of 38
BENZO(GHI)PERYLENE	2.21	1.68	2.58	2.41	3.41	2.68	2.50	2.38	2.69	2.06	1.95	1.59	2.33	6.80	0 of 38
BENZO(K)FLUORANTHENE	2.21	1.68	2.58	2.41	3.41	2.68	2.50	2.38	2.69	2.06	1.95	1.59	2.33	6.80	0 of 38
BENZOIC ACID	4.41	11.03	27.84	11.71	32.56	60.45	21.80	4.77	14.74	4.12	19.69	3.18	17.71	94.15	15 of 38
BENZYL ALCOHOL	8.75	11.13	8.80	20.18	8.98	17.67	17.88	6.98	44.54	10.93	11.24	10.86	14.57	79.09	25 of 38
BIS(2-CHLOROETHOXY)METHANE	2.21	1.68	2.58	2.41	3.41	2.68	2.50	2.38	2.69	2.06	1.95	1.59	2.33	6.80	0 of 38
BIS(2-CHLOROETHYL)ETHER	2.21	1.68	2.58	2.41	3.41	2.68	2.50	2.38	2.69	2.06	1.95	1.59	2.33	6.80	0 of 38
BIS(2-ETHYLHEXYL)PHTHALATE	2.21	1.68	17.24	14.93	10.48	19.31	21.89	13.28	2.69	19.51	8.97	12.38	11.71	39.35	25 of 38
BUTYL BENZYL PHTHALATE	2.21	1.68	2.58	2.41	3.41	2.68	2.50	2.38	2.69	5.47	1.95	1.59	2.60	12.32	1 of 38
CHRYSENE	2.21	1.68	2.58	2.41	3.41	2.68	2.50	2.38	2.69	2.06	1.95	1.59	2.33	6.80	0 of 38
DIBENZO(A,H)ANTHRACENE	2.21	1.68	2.58	2.41	3.41	2.68	2.50	2.38	2.69	2.06	1.95	1.59	2.33	6.80	0 of 38
DIBENZOFURAN	2.21	1.68	2.58	2.41	3.41	2.68	2.50	2.38	2.69	2.06	1.95	1.59	2.33	6.80	0 of 38
DIETHYL PHTHALATE	2.21	1.68	2.58	5.65	3.41	2.68	2.50	2.38	2.69	2.06	1.95	1.59	2.59	11.51	1 of 38
DIMETHYL PHTHALATE	2.21	1.68	2.58	2.41	3.41	2.68	2.50	2.38	2.69	2.06	1.95	1.59	2.33	6.80	0 of 38
DI-N-BUTYLPHTHALATE	2.21	1.68	7.13	2.41	3.41	2.68	8.05	2.38	2.69	4.80	1.95	3.93	3.53	10.44	6 of 38
DI-N-OCTYLPHTHALATE	2.21	1.68	2.58	2.41	3.41	2.68	2.50	2.38	2.69	2.06	1.95	1.59	2.33	6.80	0 of 38
FLUORANTHENE	2.21	1.68	2.58	2.41	3.41	2.68	2.50	2.38	2.69	2.06	1.95	1.59	2.33	6.80	0 of 38
FLUORENE	2.21	1.68	2.58	2.41	3.41	2.68	2.50	2.38	2.69	2.06	1.95	1.59	2.33	6.80	0 of 38
HEXACHLOROENZENE	2.21	1.68	2.58	2.41	3.41	2.68	2.50	2.38	2.69	2.06	1.95	1.59	2.33	6.80	0 of 38
HEXACHLOROBUTADIENE	2.21	1.68	2.58	2.41	3.41	2.68	2.50	2.38	2.69	2.06	1.95	1.59	2.33	6.80	0 of 38
HEXACHLOROCYCLOPENTADIENE	11.03	8.40	12.91	12.03	17.05	13.39	12.52	11.92	13.46	10.29	9.73	7.94	11.65	33.98	0 of 38
HEXACHLOROETHANE	2.21	1.68	2.58	2.41	3.41	2.68	2.50	2.38	2.69	2.06	1.95	1.59	2.33	6.80	0 of 38
INDENO(1,2,3-CD)PYRENE	2.21	1.68	2.58	2.41	3.41	2.68	2.50	2.38	2.69	2.06	1.95	1.59	2.33	6.80	0 of 38
ISOPHORONE	2.21	1.68	2.58	2.41	3.41	2.68	2.50	2.38	2.69	2.06	1.95	1.59	2.33	6.80	0 of 38
NAPHTHALENE	2.21	1.68	2.58	2.41	3.41	2.68	2.50	2.38	2.69	2.06	1.95	1.59	2.33	6.80	0 of 38
NITROBENZENE	2.21	1.68	2.58	2.41	3.41	2.68	2.50	2.38	2.69	2.06	1.95	1.59	2.33	6.80	0 of 38
N-NITROSODIMETHYLAMINE	2.21	1.68	2.58	2.41	3.41	2.68	2.50	2.38	2.69	2.06	1.95	1.59	2.33	6.80	0 of 38
N-NITROSODI-N-PROPYLAMINE	2.21	1.68	2.58	2.41	3.41	2.68	2.50	2.38	2.69	2.06	1.95	1.59	2.33	6.80	0 of 38
N-NITROSODIPHENYLAMINE	2.21	1.68	2.58	2.41	3.41	2.68	2.50	2.38	2.69	2.06	1.95	1.59	2.33	6.80	0 of 38
PENTACHLOROPHENOL	11.03	8.40	12.91	8.41	10.23	8.03	7.51	7.15	8.08	6.18	5.84	4.76	8.22	23.03	0 of 38
PHENANTHRENE	0.69	0.17	0.26	0.24	0.34	0.27	0.25	0.24	0.27	0.21	0.19	0.16	0.28	2.10	0 of 38
PHENOL	4.41	3.36	5.17	4.81	6.82	11.75	5.01	4.77	5.38	4.12	3.89	3.18	5.17	16.80	2 of 38
PYRENE	2.21	1.68	2.58	2.41	3.41	2.68	2.50	2.38	2.69	2.06	1.95	1.59	2.33	6.80	0 of 38

Table A-5 Deer Island Influent Loadings (North System), Fiscal Year 1999, cont.

Volatile Organics (lbs/day)															Times Detected
	Jul	Aug	Sep	Oct	Nov	Dec	Jan	Feb	Mar	Apr	May	Jun	Average	Maximum	
1,1,1-TRICHLOROETHANE	0.97	0.84	0.79	1.03	0.83	0.77	0.91	1.13	1.11	0.91	0.86	0.77	0.91	1.53	0 of 36
1,1,2,2-TETRACHLOROETHANE	0.97	0.84	0.79	1.03	0.83	0.77	0.91	1.13	1.11	0.91	0.86	0.77	0.91	1.53	0 of 36
1,1,2-TRICHLOROETHANE	0.97	0.84	0.79	1.03	0.83	0.77	0.91	1.13	1.11	0.91	0.86	0.77	0.91	1.53	0 of 36
1,1-DICHLOROETHANE	0.97	0.84	0.79	1.03	0.83	0.77	0.91	1.13	1.11	0.91	0.86	0.77	0.91	1.53	0 of 36
1,1-DICHLOROETHENE	0.97	0.84	0.79	1.03	0.83	0.77	0.91	1.13	1.11	2.29	0.86	0.77	1.03	5.05	1 of 36
1,2-DICHLOROBENZENE	0.97	0.84	0.79	1.03	0.83	0.77	0.91	1.13	1.11	0.91	0.86	0.77	0.91	1.53	0 of 36
1,2-DICHLOROETHANE	0.97	0.84	0.79	1.03	0.83	0.77	0.91	1.13	1.11	0.91	0.86	0.77	0.91	1.53	0 of 36
1,2-DICHLOROPROPANE	0.97	0.84	0.79	1.03	0.83	0.77	0.91	1.13	1.11	0.91	0.86	0.77	0.91	1.53	0 of 36
1,3-DICHLOROBENZENE	0.97	0.84	0.79	1.03	0.83	0.77	0.91	1.13	1.11	0.91	0.86	0.77	0.91	1.53	0 of 36
1,4-DICHLOROBENZENE	0.97	0.84	0.79	1.03	0.83	0.77	0.91	1.13	2.62	0.91	0.86	1.85	1.13	5.65	2 of 36
2-BUTANONE	0.97	0.84	9.93	4.29	3.84	5.95	0.91	3.91	3.98	9.57	6.90	3.86	4.75	12.86	15 of 36
2-CHLOROETHYL VINYL ETHER	0.97	0.84	0.79	1.03	0.83	0.77	0.91	1.13	1.11	0.91	0.86	0.77	0.91	1.53	0 of 36
2-HEXANONE	0.97	0.84	0.79	1.03	0.83	0.77	0.91	1.13	1.11	0.91	0.86	0.77	0.91	1.53	0 of 36
4-METHYL-2-PENTANONE	0.97	0.84	0.79	1.03	0.83	0.77	0.91	1.13	1.11	0.91	0.86	0.77	0.91	1.53	0 of 36
ACETONE	263.99	281.30	261.21	360.45	200.97	158.15	268.74	228.25	348.14	221.55	195.35	178.16	244.32	549.51	36 of 36
ACROLEIN	0.97	0.84	0.79	1.03	0.83	0.77	0.91	1.13	1.11	0.91	0.86	0.77	0.91	1.53	0 of 36
ACRYLONITRILE	0.97	0.84	0.79	1.03	0.83	0.77	0.91	1.13	1.11	0.91	0.86	0.77	0.91	1.53	0 of 36
BENZENE	0.97	0.84	0.79	1.03	0.83	0.77	0.91	1.13	1.11	0.91	0.86	0.77	0.91	1.53	0 of 36
BROMODICHLOROMETHANE	0.97	0.84	0.79	1.03	0.83	0.77	2.88	1.13	1.11	0.91	0.86	0.77	1.08	6.77	1 of 36
BROMOFORM	0.97	0.84	0.79	1.03	0.83	0.77	0.91	1.13	1.11	0.91	0.86	0.77	0.91	1.53	0 of 36
BROMOMETHANE	0.97	0.84	0.79	1.03	0.83	0.77	0.91	1.13	1.11	0.91	0.86	0.77	0.91	1.53	0 of 36
CARBON DISULFIDE	4.31	0.84	7.19	1.03	12.17	2.65	2.32	2.85	1.11	5.93	0.86	2.77	3.76	25.19	11 of 36
CARBON TETRACHLORIDE	0.97	0.84	0.79	1.03	0.83	0.77	0.91	1.13	1.11	0.91	0.86	0.77	0.91	1.53	0 of 36
CHLOROBENZENE	0.97	0.84	0.79	1.03	0.83	0.77	0.91	1.13	1.11	0.91	0.86	0.77	0.91	1.53	0 of 36
CHLOROETHANE	0.97	0.84	0.79	1.03	0.83	0.77	0.91	1.13	1.11	0.91	0.86	0.77	0.91	1.53	0 of 36
CHLOROFORM	14.99	11.02	12.57	14.86	12.91	11.49	13.87	11.01	14.90	14.89	17.93	14.98	14.09	22.50	36 of 36
CHLOROMETHANE	0.97	0.84	0.79	1.03	0.83	0.77	0.91	1.13	1.11	0.91	2.87	0.77	1.14	8.88	1 of 36
CIS-1,2-DICHLOROETHENE	0.97	0.84	0.79	1.03	0.83	0.77	2.10	1.13	2.64	0.91	0.86	0.77	1.14	5.66	2 of 36
CIS-1,3-DICHLOROPROPENE	0.97	0.84	0.79	1.03	0.83	0.77	0.91	1.13	1.11	0.91	0.86	0.77	0.91	1.53	0 of 36
DIBROMOCHLOROMETHANE	0.97	0.84	0.79	1.03	0.83	0.77	0.91	1.13	1.11	0.91	0.86	0.77	0.91	1.53	0 of 36
ETHYLBENZENE	0.97	0.84	0.79	1.03	0.83	0.77	0.91	1.13	1.11	0.91	0.86	0.77	0.91	1.53	0 of 36
M,P-XYLENE	0.97	0.84	0.79	1.03	0.83	0.77	0.91	1.13	2.66	0.91	0.86	0.77	1.04	5.76	1 of 36
METHYLENE CHLORIDE	5.29	16.54	3.92	4.39	13.10	5.62	0.91	8.46	8.57	11.63	4.91	9.05	7.06	20.31	24 of 36
O-XYLENE	0.97	0.84	0.79	1.03	0.83	0.77	0.91	1.13	1.11	0.91	0.86	0.77	0.91	1.53	0 of 36
STYRENE	0.97	0.84	0.79	1.03	0.83	0.77	0.91	1.13	1.11	0.91	0.86	0.77	0.91	1.53	0 of 36
TETRACHLOROETHENE	3.38	0.84	4.49	6.69	0.83	1.83	5.24	4.77	15.76	5.60	4.03	15.37	5.89	41.09	19 of 36
TOLUENE	10.16	7.64	8.33	8.98	8.38	9.98	5.99	4.79	6.42	7.05	9.97	8.21	8.13	17.78	33 of 36
TRANS-1,2-DICHLOROETHENE	0.97	0.84	0.79	1.03	0.83	0.77	0.91	1.13	1.11	0.91	0.86	0.77	0.91	1.53	0 of 36

Table A-5 Deer Island Influent Loadings (North System), Fiscal Year 1999, cont.

Volatile Organics (lbs/day)															Times
	Jul	Aug	Sep	Oct	Nov	Dec	Jan	Feb	Mar	Apr	May	Jun	Average	Maximum	Detected
TRANS-1,3-DICHLOROPROPENE	0.97	0.84	0.79	1.03	0.83	0.77	0.91	1.13	1.11	0.91	0.86	0.77	0.91	1.53	0 of 36
TRICHLOROETHENE	0.97	0.84	2.63	4.52	0.83	1.80	0.91	1.13	2.70	2.18	0.86	2.15	1.80	11.27	6 of 36
TRICHLOROFLUOROMETHANE	0.97	0.84	0.79	7.26	0.83	0.77	0.91	1.13	1.11	0.91	0.86	0.77	1.43	20.22	1 of 36
VINYL ACETATE	0.97	0.84	0.79	1.03	0.83	0.77	0.91	1.13	1.11	0.91	0.86	0.77	0.91	1.53	0 of 36
VINYL CHLORIDE	0.97	0.84	0.79	1.03	0.83	0.77	0.91	1.13	1.11	0.91	0.86	0.77	0.91	1.53	0 of 36

Notes:

Results in ***bold italics*** indicate one or more detects in the month.

Yearly averages are calculated from individual results collected in the fiscal

Non-detected compounds are assumed to equal one half of the detection limit for metals and inorganics and one tenth of the reporting limit for organic

Table A-6 Deer Island Influent Characterization (South System), Fiscal Year 1999

Metals (ug/L)													Times		
	Jul	Aug	Sep	Oct	Nov	Dec	Jan	Feb	Mar	Apr	May	Jun	Average	Maximum	Detected
ANTIMONY	20.00	20.00	20.00	20.00	12.30	8.76	8.48	13.15	11.15	7.50	7.08	7.50	13.03	20.00	0 of 71
ARSENIC	<i>0.49</i>	<i>1.16</i>	<i>0.94</i>	<i>1.00</i>	<i>0.74</i>	<i>1.32</i>	<i>0.98</i>	0.40	<i>0.64</i>	<i>0.51</i>	<i>0.72</i>	<i>0.86</i>	0.80	3.10	33 of 71
BERYLLIUM	0.50	0.50	0.50	0.50	0.36	0.25	0.25	0.36	0.25	0.25	0.25	0.25	0.35	0.50	0 of 71
BORON	<i>209.02</i>	<i>244.52</i>	<i>316.64</i>	<i>228.83</i>	<i>291.73</i>	<i>253.37</i>	<i>161.85</i>	125.00	125.00	125.00	<i>235.12</i>	<i>348.19</i>	213.44	397.00	40 of 71
CADMIUM	1.00	1.00	1.00	<i>1.56</i>	<i>1.61</i>	1.00	<i>1.14</i>	1.00	1.00	1.00	1.00	1.00	1.11	2.69	6 of 71
CHROMIUM	<i>3.70</i>	<i>3.87</i>	<i>3.52</i>	<i>3.07</i>	<i>3.62</i>	<i>4.84</i>	<i>5.20</i>	<i>3.72</i>	<i>4.64</i>	<i>3.03</i>	<i>6.91</i>	<i>5.39</i>	4.31	12.90	47 of 71
COPPER	<i>91.29</i>	<i>97.36</i>	<i>147.07</i>	<i>78.62</i>	<i>74.40</i>	<i>101.43</i>	<i>79.27</i>	<i>45.27</i>	<i>50.81</i>	<i>60.55</i>	<i>85.35</i>	<i>90.30</i>	80.80	340.00	71 of 71
HEXAVALENT CHROMIUM	5.50	5.50	5.50	5.50	5.50	5.50	5.50	5.50	5.50	5.50	5.50	5.50	5.50	5.50	0 of 34
IRON	<i>2059.74</i>	<i>2144.49</i>	<i>3196.71</i>	<i>1807.40</i>	<i>1697.83</i>	<i>2085.66</i>	<i>2157.71</i>	<i>1254.22</i>	<i>1509.13</i>	<i>1586.88</i>	<i>2248.47</i>	<i>2018.62</i>	1946.18	8160.00	71 of 71
LEAD	<i>13.47</i>	<i>12.03</i>	<i>22.53</i>	<i>15.00</i>	<i>8.90</i>	<i>13.77</i>	<i>13.49</i>	<i>6.50</i>	<i>6.87</i>	<i>7.58</i>	<i>10.03</i>	<i>10.75</i>	11.48	82.50	70 of 71
MERCURY	<i>0.40</i>	<i>0.28</i>	<i>0.58</i>	<i>0.24</i>	<i>0.21</i>	<i>0.40</i>	<i>0.28</i>	<i>0.25</i>	<i>0.21</i>	<i>0.19</i>	<i>0.35</i>	<i>0.33</i>	0.30	2.04	70 of 71
MOLYBDENUM	<i>3.57</i>	<i>5.24</i>	<i>4.63</i>	<i>6.90</i>	<i>4.49</i>	<i>5.13</i>	<i>3.31</i>	<i>1.20</i>	<i>1.43</i>	<i>2.54</i>	<i>3.29</i>	<i>7.34</i>	3.88	15.50	50 of 75
NICKEL	4.00	<i>4.79</i>	<i>4.89</i>	<i>5.88</i>	<i>4.97</i>	<i>5.76</i>	<i>4.24</i>	<i>2.47</i>	<i>4.27</i>	<i>4.01</i>	<i>6.08</i>	<i>6.77</i>	4.74	14.30	38 of 71
SELENIUM	0.53	0.45	0.52	0.77	<i>0.65</i>	0.45	0.45	0.45	0.44	0.45	0.45	<i>0.56</i>	0.51	2.25	2 of 71
SILVER	<i>3.54</i>	<i>2.51</i>	<i>6.06</i>	<i>4.43</i>	<i>3.73</i>	<i>5.36</i>	<i>2.96</i>	<i>2.19</i>	<i>2.36</i>	<i>4.13</i>	<i>3.53</i>	<i>5.97</i>	3.71	12.60	61 of 71
THALLIUM	0.50	<i>0.60</i>	0.50	<i>0.86</i>	0.50	0.50	<i>0.57</i>	0.50	0.50	0.50	0.50	0.50	0.55	1.77	4 of 71
ZINC	<i>106.00</i>	<i>118.22</i>	<i>170.44</i>	<i>104.05</i>	<i>98.01</i>	<i>139.69</i>	<i>123.30</i>	<i>74.86</i>	<i>92.35</i>	<i>101.62</i>	<i>150.90</i>	<i>139.41</i>	115.67	397.00	71 of 71

Cyanide and Phenols (ug/L)													Times		
	Jul	Aug	Sep	Oct	Nov	Dec	Jan	Feb	Mar	Apr	May	Jun	Average	Maximum	Detected
CYANIDE	5.00	5.00	5.00	5.00	5.00	5.00	5.00	5.00	5.00	5.00	5.00	5.00	5.00	5.00	0 of 34
TOTAL PHENOLS	<i>22.91</i>	<i>38.14</i>	<i>39.51</i>	<i>39.36</i>	<i>42.09</i>	<i>41.34</i>	<i>38.63</i>	<i>17.62</i>	<i>5.43</i>	<i>10.29</i>	<i>40.89</i>	<i>63.92</i>	31.29	78.00	30 of 33

Oil and Grease, Petroleum Hydrocarbons, and Surfactants (mg/L)													Times		
	Jul	Aug	Sep	Oct	Nov	Dec	Jan	Feb	Mar	Apr	May	Jun	Average	Maximum	Detected
PETROLEUM HYDROCARBON	<i>0.80</i>	<i>1.23</i>	<i>0.96</i>	<i>1.53</i>	<i>0.82</i>	<i>0.71</i>	<i>1.10</i>	<i>0.55</i>	<i>0.61</i>	<i>1.63</i>	<i>0.99</i>	<i>1.03</i>	0.98	2.40	34 of 34
TOTAL PETROLEUM HYDROCARBON	<i>3.22</i>	<i>3.06</i>	<i>2.63</i>	<i>3.51</i>	<i>3.13</i>	<i>3.08</i>	<i>6.46</i>	<i>2.33</i>	<i>1.76</i>	<i>4.81</i>	<i>2.66</i>	<i>6.04</i>	3.52	10.00	34 of 34
FATS OIL AND GREASE	<i>41.83</i>	<i>34.27</i>	<i>37.44</i>	<i>33.64</i>	<i>35.85</i>	<i>41.48</i>	<i>24.27</i>	<i>24.19</i>	<i>27.34</i>	<i>39.63</i>	<i>43.38</i>	<i>34.47</i>	33.73	104.00	72 of 72
MBAS	<i>4.36</i>	<i>5.04</i>	<i>4.28</i>	<i>3.80</i>	<i>4.17</i>	<i>5.35</i>	<i>4.08</i>	<i>2.71</i>	<i>2.72</i>	<i>3.67</i>	<i>4.66</i>	<i>5.70</i>	4.09	7.16	33 of 33

Table A-6 Deer Island Influent Characterization (South System), Fiscal Year 1999, cont.

Organochlorine Pesticides and PCBs (ug/L)	Jul	Aug	Sep	Oct	Nov	Dec	Jan	Feb	Mar	Apr	May	Jun	Average	Maximum	Times Detected
4,4'-DDD	0.002	0.002	0.002	0.002	0.002	0.003	0.002	0.002	0.002	0.002	0.002	0.002	0.002	0.004	0 of 33
4,4'-DDE	0.002	0.002	0.002	0.002	0.002	0.003	0.002	0.002	0.002	0.002	0.002	0.002	0.002	0.004	0 of 33
4,4'-DDT	0.002	0.002	0.002	0.002	0.002	0.003	0.002	0.002	0.002	0.002	0.002	0.002	0.002	0.004	0 of 33
ALDRIN	0.002	0.002	0.002	0.002	0.002	0.003	0.002	0.002	0.002	0.002	0.002	0.002	0.002	0.004	0 of 33
ALPHA-BHC	0.002	0.002	0.002	0.002	0.002	0.003	0.002	0.002	0.002	0.002	0.002	0.002	0.002	0.004	0 of 33
ALPHA-CHLORDANE	0.002	0.002	0.008	0.002	0.002	0.003	0.002	0.002	0.002	0.002	0.002	0.002	0.003	0.019	1 of 33
AROCLOR-1016	0.053	0.052	0.057	0.062	0.057	0.068	0.053	0.053	0.056	0.056	0.053	0.052	0.056	0.098	0 of 33
AROCLOR-1221	0.106	0.104	0.113	0.083	0.113	0.136	0.106	0.106	0.113	0.113	0.105	0.105	0.109	0.196	0 of 33
AROCLOR-1232	0.053	0.052	0.057	0.062	0.057	0.068	0.053	0.053	0.056	0.056	0.053	0.052	0.056	0.098	0 of 33
AROCLOR-1242	0.053	0.052	0.057	0.062	0.057	0.068	0.053	0.053	0.056	0.056	0.053	0.052	0.056	0.098	0 of 33
AROCLOR-1248	0.053	0.052	0.057	0.062	0.057	0.068	0.053	0.053	0.056	0.056	0.053	0.052	0.056	0.098	0 of 33
AROCLOR-1254	0.053	0.052	0.057	0.062	0.057	0.068	0.053	0.053	0.056	0.056	0.053	0.052	0.056	0.098	0 of 33
AROCLOR-1260	0.053	0.052	0.057	0.062	0.057	0.068	0.053	0.053	0.056	0.056	0.053	0.052	0.056	0.098	0 of 33
BETA-BHC	0.002	0.002	0.002	0.002	0.002	0.003	0.002	0.002	0.002	0.002	0.002	0.002	0.002	0.004	0 of 33
CHLORDANE (TECHNICAL)	0.053	0.052	0.057	0.062	0.057	0.068	0.053	0.053	0.056	0.056	0.053	0.052	0.056	0.098	0 of 33
DELTA-BHC	0.002	0.002	0.002	0.002	0.002	0.009	0.002	0.002	0.002	0.002	0.002	0.002	0.003	0.022	1 of 33
DIELDRIN	0.002	0.002	0.002	0.002	0.002	0.003	0.002	0.002	0.002	0.002	0.002	0.002	0.002	0.004	0 of 33
ENDOSULFAN I	0.002	0.002	0.002	0.002	0.002	0.003	0.002	0.002	0.002	0.002	0.002	0.002	0.002	0.004	0 of 33
ENDOSULFAN II	0.002	0.002	0.002	0.002	0.002	0.003	0.002	0.002	0.002	0.002	0.002	0.002	0.002	0.004	0 of 33
ENDOSULFAN SULFATE	0.002	0.002	0.002	0.002	0.002	0.003	0.002	0.002	0.002	0.002	0.002	0.002	0.002	0.004	0 of 33
ENDRIN	0.002	0.002	0.002	0.002	0.002	0.003	0.002	0.002	0.002	0.002	0.002	0.002	0.002	0.004	0 of 33
ENDRIN ALDEHYDE	0.002	0.002	0.002	0.002	0.002	0.003	0.002	0.002	0.002	0.002	0.002	0.002	0.002	0.004	0 of 33
ENDRIN KETONE	0.002	0.002	0.002	0.002	0.002	0.003	0.002	0.002	0.002	0.002	0.002	0.002	0.002	0.004	0 of 33
GAMMA-BHC (LINDANE)	0.002	0.002	0.002	0.002	0.002	0.022	0.002	0.002	0.002	0.002	0.002	0.007	0.004	0.040	3 of 33
GAMMA-CHLORDANE	0.002	0.002	0.007	0.002	0.002	0.003	0.002	0.002	0.002	0.002	0.002	0.002	0.003	0.015	1 of 33
HEPTACHLOR	0.002	0.002	0.002	0.002	0.002	0.003	0.002	0.002	0.002	0.002	0.002	0.002	0.002	0.004	0 of 33
HEPTACHLOR EPOXIDE	0.002	0.002	0.002	0.002	0.002	0.003	0.002	0.002	0.002	0.002	0.002	0.002	0.002	0.004	0 of 33
METHOXYCHLOR	0.021	0.021	0.023	0.025	0.023	0.027	0.021	0.021	0.022	0.022	0.021	0.021	0.022	0.039	0 of 33
TOXAPHENE	0.053	0.052	0.057	0.062	0.057	0.068	0.053	0.053	0.056	0.056	0.053	0.052	0.056	0.098	0 of 33

Table A-6 Deer Island Influent Characterization (South System), Fiscal Year 1999, cont.

Semivolatile Organics (ug/L)	Jul	Aug	Sep	Oct	Nov	Dec	Jan	Feb	Mar	Apr	May	Jun	Average	Maximum	Times Detected
1,2,4-TRICHLOROBENZENE	1.09	1.04	1.51	1.20	1.05	1.62	1.14	1.05	1.16	1.53	1.11	1.08	1.21	2.44	0 of 33
1,2-DICHLOROBENZENE	1.09	1.04	1.51	1.20	1.05	1.62	1.14	1.05	1.16	1.53	1.11	1.08	1.21	2.44	0 of 33
1,2-DIPHENYLHYDRAZINE (AS AZOB)	1.09	1.04	1.51	1.20	1.05	1.62	1.14	1.05	1.16	1.53	1.11	1.08	1.21	2.44	0 of 33
1,3-DICHLOROBENZENE	1.09	1.04	1.51	1.20	1.05	1.62	1.14	1.05	1.16	1.53	1.11	1.08	1.21	2.44	0 of 33
1,4-DICHLOROBENZENE	1.09	1.04	1.51	1.20	1.05	1.62	1.14	1.05	1.16	1.53	1.11	1.08	1.21	2.44	0 of 33
2,2'-OXYBIS(1-CHLOROPROPANE)	1.09	1.04	1.51	1.20	1.05	1.62	1.14	1.05	1.16	1.53	1.11	1.08	1.21	2.44	0 of 33
2,4,5-TRICHLOROPHENOL	1.09	1.04	1.51	1.20	1.05	1.62	1.14	1.05	1.16	1.53	1.11	1.08	1.21	2.44	0 of 33
2,4,6-TRICHLOROPHENOL	1.09	1.04	1.51	1.20	1.05	1.62	1.14	1.05	1.16	1.53	1.11	1.08	1.21	2.44	0 of 33
2,4-DICHLOROPHENOL	1.09	1.04	1.51	1.20	1.05	1.62	1.14	1.05	1.16	1.53	1.11	1.08	1.21	2.44	0 of 33
2,4-DIMETHYLPHENOL	1.09	1.04	1.51	1.20	1.05	1.62	1.14	1.05	1.16	1.53	1.11	1.08	1.21	2.44	0 of 33
2,4-DINITROPHENOL	2.18	2.09	3.01	2.40	2.09	3.24	2.29	2.10	2.32	3.05	2.22	2.15	2.42	4.88	0 of 33
2,4-DINITROTOLUENE	1.09	1.04	1.51	1.20	1.05	1.62	1.14	1.05	1.16	1.53	1.11	1.08	1.21	2.44	0 of 33
2,6-DINITROTOLUENE	1.09	1.04	1.51	1.20	1.05	1.62	1.14	1.05	1.16	1.53	1.11	1.08	1.21	2.44	0 of 33
2-CHLORONAPHTHALENE	1.09	1.04	1.51	1.20	1.05	1.62	1.14	1.05	1.16	1.53	1.11	1.08	1.21	2.44	0 of 33
2-CHLOROPHENOL	1.09	1.04	1.51	1.20	1.05	1.62	1.14	1.05	1.16	1.53	1.11	1.08	1.21	2.44	0 of 33
2-METHYL-4,6-DINITROPHENOL	10.90	10.43	15.07	11.98	10.45	16.21	11.43	10.49	11.62	15.27	11.11	10.77	12.10	24.40	0 of 33
2-METHYLNAPHTHALENE	1.09	1.04	1.51	1.20	1.05	1.62	1.14	1.05	1.16	1.53	1.11	1.08	1.21	2.44	0 of 33
2-METHYLPHENOL	1.09	1.04	1.51	1.20	1.05	1.62	1.14	1.05	1.16	1.53	1.11	1.08	1.21	2.44	0 of 33
2-NITROANILINE	1.09	1.04	1.51	1.20	1.05	1.62	1.14	1.05	1.16	1.53	1.11	1.08	1.21	2.44	0 of 33
2-NITROPHENOL	1.09	1.04	1.51	1.20	1.05	1.62	1.14	1.05	1.16	1.53	1.11	1.08	1.21	2.44	0 of 33
3,3'-DICHLOROBENZIDINE	2.18	2.09	3.01	2.40	2.09	3.24	2.29	2.10	2.32	3.05	2.22	2.15	2.42	4.88	0 of 33
3-NITROANILINE	1.09	1.04	1.51	1.20	1.05	1.62	1.14	1.05	1.16	1.53	1.11	1.08	1.21	2.44	0 of 33
4-BROMOPHENYL PHENYL ETHER	1.09	1.04	1.51	1.20	1.05	1.62	1.14	1.05	1.16	1.53	1.11	1.08	1.21	2.44	0 of 33
4-CHLORO-3-METHYLPHENOL	1.09	1.04	1.51	1.20	1.05	1.62	1.14	1.05	1.16	1.53	1.11	1.08	1.21	2.44	0 of 33
4-CHLOROANILINE	1.09	1.04	1.51	1.20	1.05	1.62	1.14	1.05	1.16	1.53	1.11	1.08	1.21	2.44	0 of 33
4-CHLOROPHENYL PHENYL ETHER	1.09	1.04	1.51	1.20	1.05	1.62	1.14	1.05	1.16	1.53	1.11	1.08	1.21	2.44	0 of 33
4-METHYLPHENOL (INCLUDES 3-MET)	10.56	18.36	27.98	14.09	16.73	30.56	18.07	3.74	1.16	5.03	17.94	31.67	15.04	54.75	28 of 33
4-NITROANILINE	1.09	1.04	1.51	1.20	1.05	1.62	1.14	1.05	1.16	1.53	1.11	1.08	1.21	2.44	0 of 33
4-NITROPHENOL	2.18	2.09	3.01	2.40	2.09	3.24	2.29	2.10	2.32	3.05	2.22	2.15	2.42	4.88	0 of 33
ACENAPHTHENE	1.09	1.04	1.51	1.20	1.05	1.62	1.14	1.05	1.16	1.53	1.11	1.08	1.21	2.44	0 of 33
ACENAPHTHYLENE	1.09	1.04	1.51	1.20	1.05	1.62	1.14	1.05	1.16	1.53	1.11	1.08	1.21	2.44	0 of 33
ANILINE	1.09	1.04	1.51	1.20	1.05	1.62	1.14	1.05	1.16	1.53	1.11	1.08	1.21	2.44	0 of 33
ANTHRACENE	1.09	1.04	1.51	1.20	1.05	1.62	1.14	1.05	1.16	1.53	1.11	1.08	1.21	2.44	0 of 33
BENZIDINE	5.45	5.22	7.53	5.99	5.23	8.10	5.72	5.25	5.81	7.64	5.56	5.38	6.05	12.20	0 of 33
BENZO(A)ANTHRACENE	1.09	1.04	1.51	1.20	1.05	1.62	1.14	1.05	1.16	1.53	1.11	1.08	1.21	2.44	0 of 33

Table A-6 Deer Island Influent Characterization (South System), Fiscal Year 1999, cont.

Semivolatile Organics (ug/L)	Jul	Aug	Sep	Oct	Nov	Dec	Jan	Feb	Mar	Apr	May	Jun	Average	Maximum	Times Detected
BENZO(A)PYRENE	1.09	1.04	1.51	1.20	1.05	1.62	1.14	1.05	1.16	1.53	1.11	1.08	1.21	2.44	0 of 33
BENZO(B)FLUORANTHENE	1.09	1.04	1.51	1.20	1.05	1.62	1.14	1.05	1.16	1.53	1.11	1.08	1.21	2.44	0 of 33
BENZO(GHI)PERYLENE	1.09	1.04	1.51	1.20	1.05	1.62	1.14	1.05	1.16	1.53	1.11	1.08	1.21	2.44	0 of 33
BENZO(K)FLUORANTHENE	1.09	1.04	1.51	1.20	1.05	1.62	1.14	1.05	1.16	1.53	1.11	1.08	1.21	2.44	0 of 33
BENZOIC ACID	2.18	8.56	13.27	7.35	2.09	36.82	10.21	2.10	2.32	3.05	19.15	2.15	9.00	63.76	13 of 33
BENZYL ALCOHOL	8.83	11.00	7.06	9.38	6.35	10.71	8.45	1.05	27.72	6.94	10.15	13.03	9.82	31.20	24 of 33
BIS(2-CHLOROETHOXY)METHANE	1.09	1.04	1.51	1.20	1.05	1.62	1.14	1.05	1.16	1.53	1.11	1.08	1.21	2.44	0 of 33
BIS(2-CHLOROETHYL)ETHER	1.09	1.04	1.51	1.20	1.05	1.62	1.14	1.05	1.16	1.53	1.11	1.08	1.21	2.44	0 of 33
BIS(2-ETHYLHEXYL)PHTHALATE	1.09	3.38	14.07	8.34	6.86	11.68	11.10	10.93	6.56	6.39	2.54	9.06	7.78	29.20	24 of 33
BUTYL BENZYL PHTHALATE	1.09	1.04	1.51	1.20	1.05	1.62	1.14	1.05	1.16	1.53	1.11	1.08	1.21	2.44	0 of 33
CHRYSENE	1.09	1.04	1.51	1.20	1.05	1.62	1.14	1.05	1.16	1.53	1.11	1.08	1.21	2.44	0 of 33
DIBENZO(A,H)ANTHRACENE	1.09	1.04	1.51	1.20	1.05	1.62	1.14	1.05	1.16	1.53	1.11	1.08	1.21	2.44	0 of 33
DIBENZOFURAN	1.09	1.04	1.51	1.20	1.05	1.62	1.14	1.05	1.16	1.53	1.11	1.08	1.21	2.44	0 of 33
DIETHYL PHTHALATE	1.09	1.04	1.51	1.20	1.05	1.62	1.14	1.05	1.16	1.53	1.11	1.08	1.21	2.44	0 of 33
DIMETHYL PHTHALATE	1.09	1.04	1.51	1.20	1.05	1.62	1.14	1.05	1.16	1.53	1.11	1.08	1.21	2.44	0 of 33
DI-N-BUTYLPHTHALATE	1.09	2.49	7.62	2.93	1.05	1.62	1.14	1.05	1.16	1.53	2.22	7.05	2.38	15.48	8 of 33
DI-N-OCTYLPHTHALATE	1.09	1.04	1.51	1.20	1.05	1.62	1.14	1.05	1.16	1.53	1.11	1.08	1.21	2.44	0 of 33
FLUORANTHENE	1.09	1.04	1.51	1.20	1.05	1.62	1.14	1.05	1.16	1.53	1.11	1.08	1.21	2.44	0 of 33
FLUORENE	1.09	1.04	1.51	1.20	1.05	1.62	1.14	1.05	1.16	1.53	1.11	1.08	1.21	2.44	0 of 33
HEXACHLOROBENZENE	1.09	1.04	1.51	1.20	1.05	1.62	1.14	1.05	1.16	1.53	1.11	1.08	1.21	2.44	0 of 33
HEXACHLOROBUTADIENE	1.09	1.04	1.51	1.20	1.05	1.62	1.14	1.05	1.16	1.53	1.11	1.08	1.21	2.44	0 of 33
HEXACHLOROCYCLOPENTADIENE	5.45	5.22	7.53	5.99	5.23	8.10	5.72	5.25	5.81	7.64	5.56	5.38	6.05	12.20	0 of 33
HEXACHLOROETHANE	1.09	1.04	1.51	1.20	1.05	1.62	1.14	1.05	1.16	1.53	1.11	1.08	1.21	2.44	0 of 33
INDENO(1,2,3-CD)PYRENE	1.09	1.04	1.51	1.20	1.05	1.62	1.14	1.05	1.16	1.53	1.11	1.08	1.21	2.44	0 of 33
ISOPHORONE	1.09	1.04	1.51	1.20	1.05	1.62	1.14	1.05	1.16	1.53	1.11	1.08	1.21	2.44	0 of 33
NAPHTHALENE	1.09	1.04	1.51	1.20	1.05	1.62	1.14	1.05	1.16	1.53	1.11	1.08	1.21	2.44	0 of 33
NITROBENZENE	1.09	1.04	1.51	1.20	1.05	1.62	1.14	1.05	1.16	1.53	1.11	1.08	1.21	2.44	0 of 33
N-NITROSODIMETHYLAMINE	1.09	1.04	1.51	1.20	1.05	1.62	1.14	1.05	1.16	1.53	1.11	1.08	1.21	2.44	0 of 33
N-NITROSDI-N-PROPYLAMINE	1.09	1.04	1.51	1.20	1.05	1.62	1.14	1.05	1.16	1.53	1.11	1.08	1.21	2.44	0 of 33
N-NITROSODIPHENYLAMINE	1.09	1.04	1.51	1.20	1.05	1.62	1.14	1.05	1.16	1.53	1.11	1.08	1.21	2.44	0 of 33
PENTACHLOROPHENOL	5.45	5.22	7.53	3.60	3.14	4.86	3.43	3.15	3.49	4.58	3.33	3.23	4.13	11.50	0 of 33
PHENANTHRENE	0.11	0.10	0.15	0.12	0.10	0.16	0.11	0.10	0.12	0.15	0.11	0.11	0.12	0.24	0 of 33
PHENOL	2.18	7.62	3.01	3.68	4.72	6.79	5.14	2.10	2.32	3.05	4.35	7.92	4.22	19.29	11 of 33
PYRENE	1.09	1.04	1.51	1.20	1.05	1.62	1.14	1.05	1.16	1.53	1.11	1.08	1.21	2.44	0 of 33

Table A-6 Deer Island Influent Characterization (South System), Fiscal Year 1999, cont.

Volatile Organics (ug/L)													Average	Maximum	Times	
	Jul	Aug	Sep	Oct	Nov	Dec	Jan	Feb	Mar	Apr	May	Jun			Detected	
1,1,1-TRICHLOROETHANE	0.50	0.50	0.50	0.50	0.50	0.50	0.50	0.50	0.50	0.50	0.50	0.50	0.50	0.50	0.50	0 of 34
1,1,2,2-TETRACHLOROETHANE	0.50	0.50	0.50	0.50	0.50	0.50	0.50	0.50	0.50	0.50	0.50	0.50	0.50	0.50	0.50	0 of 34
1,1,2-TRICHLOROETHANE	0.50	0.50	0.50	0.50	0.50	0.50	0.50	0.50	0.50	0.50	0.50	0.50	0.50	0.50	0.50	0 of 34
1,1-DICHLOROETHANE	0.50	0.50	0.50	0.50	0.50	0.50	0.50	0.50	0.50	0.50	0.50	0.50	0.50	0.50	0.50	0 of 34
1,1-DICHLOROETHENE	0.50	0.50	0.50	0.50	0.50	0.50	0.50	0.50	0.50	0.50	0.50	0.50	0.50	0.50	0.50	0 of 34
1,2-DICHLOROBENZENE	0.50	0.50	0.50	0.50	0.50	0.50	0.50	0.50	0.50	0.50	0.50	0.50	0.50	0.50	0.50	0 of 34
1,2-DICHLOROETHANE	0.50	0.50	0.50	0.50	0.50	0.50	0.50	0.50	0.50	0.50	0.50	0.50	0.50	0.50	0.50	0 of 34
1,2-DICHLOROPROPANE	0.50	0.50	0.50	0.50	0.50	0.50	0.50	0.50	0.50	0.50	0.50	0.50	0.50	0.50	0.50	0 of 34
1,3-DICHLOROBENZENE	0.50	0.50	0.50	0.50	0.50	0.50	0.50	0.50	0.50	0.50	0.50	0.50	0.50	0.50	0.50	0 of 34
1,4-DICHLOROBENZENE	3.12	1.95	1.40	0.50	0.50	0.50	0.50	0.50	0.50	0.50	0.50	1.43	0.89	3.23	6 of 34	
2-BUTANONE	0.50	6.28	9.49	8.20	10.95	3.93	6.43	6.76	0.50	7.88	5.69	9.09	6.32	12.89	23 of 34	
2-CHLOROETHYL VINYL ETHER	0.50	0.50	0.50	0.50	0.50	0.50	0.50	0.50	0.50	0.50	0.50	0.50	0.50	0.50	0.50	0 of 34
2-HEXANONE	0.50	0.50	0.50	0.50	0.50	0.50	0.50	0.50	0.50	0.50	0.50	0.50	0.50	0.50	0.50	0 of 34
4-METHYL-2-PENTANONE	0.50	0.50	0.50	0.50	0.50	0.50	0.50	0.50	0.50	0.50	0.50	0.50	0.50	0.50	0.50	0 of 34
ACETONE	227.69	163.79	256.76	165.85	158.50	102.28	112.20	100.59	93.50	156.12	133.12	128.86	143.69	369.00	34 of 34	
ACROLEIN	0.50	0.50	0.50	0.50	0.50	0.50	0.50	0.50	0.50	0.50	0.50	0.50	0.50	0.50	0.50	0 of 34
ACRYLONITRILE	0.50	0.50	0.50	0.50	0.50	0.50	0.50	0.50	0.50	0.50	0.50	0.50	0.50	0.50	0.50	0 of 34
BENZENE	0.50	0.50	0.50	0.50	0.50	0.50	0.50	0.50	0.50	0.50	0.50	0.50	0.50	0.50	0.50	0 of 34
BROMODICHLOROMETHANE	0.50	0.50	0.50	0.50	0.50	0.50	0.50	0.50	0.50	0.50	0.50	0.50	0.50	0.50	0.50	0 of 34
BROMOFORM	0.50	0.50	0.50	0.50	0.50	0.50	0.50	0.50	0.50	0.50	0.50	0.50	0.50	0.50	0.50	0 of 34
BROMOMETHANE	0.50	0.50	0.50	0.50	0.50	0.50	0.50	0.50	0.50	0.50	0.50	0.50	0.50	0.50	0.50	0 of 34
CARBON DISULFIDE	2.20	0.50	0.50	0.50	1.18	1.71	1.82	0.50	0.50	2.95	0.50	8.05	1.63	10.80	10 of 34	
CARBON TETRACHLORIDE	0.50	0.50	0.50	0.50	0.50	0.50	0.50	0.50	0.50	0.50	0.50	0.50	0.50	0.50	0.50	0 of 34
CHLOROBENZENE	0.50	0.50	0.50	0.50	0.50	0.50	0.50	0.50	0.50	0.50	0.50	0.50	0.50	0.50	0.50	0 of 34
CHLOROETHANE	0.50	0.50	0.50	0.50	0.50	0.50	0.50	0.50	0.50	0.50	0.50	0.50	0.50	0.50	0.50	0 of 34
CHLOROFORM	5.94	5.05	6.07	4.51	4.99	7.46	3.99	3.29	3.35	5.61	7.75	7.40	5.34	8.96	34 of 34	
CHLOROMETHANE	0.50	0.50	0.50	0.50	0.50	0.50	0.50	0.50	0.50	0.50	0.50	0.50	0.50	0.50	0.50	0 of 34
CIS-1,2-DICHLOROETHENE	0.50	0.50	0.50	0.50	0.50	0.50	0.50	0.50	0.50	0.50	0.50	0.50	0.50	0.50	0.50	0 of 34
CIS-1,3-DICHLOROPROPENE	0.50	0.50	0.50	0.50	0.50	0.50	0.50	0.50	0.50	0.50	0.50	0.50	0.50	0.50	0.50	0 of 34
DIBROMOCHLOROMETHANE	0.50	0.50	0.50	0.50	0.50	0.50	0.50	0.50	0.50	0.50	0.50	0.50	0.50	0.50	0.50	0 of 34
ETHYLBENZENE	0.50	0.50	0.50	0.50	0.50	0.50	0.50	0.50	0.50	0.50	0.50	0.50	0.50	0.50	0.50	0 of 34
M,P-XYLENE	0.50	0.50	0.50	0.50	0.50	0.50	0.50	0.50	0.50	0.50	0.50	1.76	0.59	4.18	1 of 34	
METHYLENE CHLORIDE	3.48	2.35	12.47	4.18	24.59	3.66	3.00	2.09	0.50	18.82	20.07	10.60	8.99	52.30	21 of 34	
O-XYLENE	0.50	0.50	0.50	0.50	0.50	0.50	0.50	0.50	0.50	0.50	0.50	0.50	0.50	0.50	0.50	0 of 34

Table A-6 Deer Island Influent Characterization (South System), Fiscal Year 1999, cont.

Volatile Organics (ug/L)	Jul	Aug	Sep	Oct	Nov	Dec	Jan	Feb	Mar	Apr	May	Jun	Average	Maximum	Times Detected
STYRENE	0.50	0.50	0.50	0.50	0.50	0.50	0.50	0.50	0.50	0.50	0.50	0.50	0.50	0.50	0 of 34
TETRACHLOROETHENE	9.77	7.22	2.47	2.55	5.29	1.22	1.50	1.23	0.50	2.76	3.47	2.26	3.09	15.10	23 of 34
TOLUENE	3.39	4.50	3.51	4.86	3.35	6.47	3.93	0.50	0.50	2.02	5.79	7.19	3.60	10.60	27 of 34
TRANS-1,2-DICHLOROETHENE	0.50	0.50	0.50	0.50	0.50	0.50	0.50	0.50	0.50	0.50	0.50	0.50	0.50	0.50	0 of 34
TRANS-1,3-DICHLOROPROPENE	0.50	0.50	0.50	0.50	0.50	0.50	0.50	0.50	0.50	0.50	0.50	0.50	0.50	0.50	0 of 34
TRICHLOROETHENE	0.50	0.50	0.50	0.50	0.50	1.20	0.50	0.50	0.50	0.50	0.50	0.50	0.55	2.62	1 of 34
TRICHLOROFLUOROMETHANE	0.50	0.50	0.50	0.50	0.50	0.50	0.50	0.50	0.50	0.50	0.50	0.50	0.50	0.50	0 of 34
VINYL ACETATE	0.50	0.50	0.50	0.50	0.50	0.50	0.50	0.50	0.50	0.50	0.50	0.50	0.50	0.50	0 of 34
VINYL CHLORIDE	0.50	0.50	0.50	0.50	0.50	0.50	0.50	0.50	0.50	0.50	0.50	0.50	0.50	0.50	0 of 34

Notes:

Results in **bold italics** indicate one or more detects in the month.

Yearly averages are calculated from individual results collected in the fiscal year.

Non-detected compounds are assumed to equal one half of the detection limit for metals and inorganics and one tenth of the reporting limit for organic

Table A-7 Deer Island Influent Loadings (South System), Fiscal Year 1999

Metals (lbs/day)													Times		
	Jul	Aug	Sep	Oct	Nov	Dec	Jan	Feb	Mar	Apr	May	Jun	Average	Maximum	Detected
ANTIMONY	20.02	16.30	15.20	20.10	10.01	6.72	10.23	18.03	16.86	7.97	6.38	5.70	12.80	30.28	0 of 71
ARSENIC	<i>0.49</i>	<i>0.94</i>	<i>0.71</i>	<i>1.01</i>	<i>0.60</i>	<i>1.02</i>	<i>1.18</i>	0.55	<i>0.97</i>	<i>0.54</i>	<i>0.65</i>	<i>0.65</i>	0.79	2.35	33 of 71
BERYLLIUM	0.50	0.41	0.38	0.50	0.29	0.19	0.30	0.50	0.38	0.27	0.23	0.19	0.34	0.83	0 of 71
BORON	<i>209.24</i>	<i>199.28</i>	<i>240.57</i>	<i>229.95</i>	<i>237.45</i>	<i>194.44</i>	<i>195.18</i>	171.38	189.04	132.78	<i>211.91</i>	<i>264.43</i>	209.65	317.55	40 of 71
CADMIUM	1.00	0.82	0.76	<i>1.57</i>	<i>1.31</i>	0.77	<i>1.38</i>	1.37	1.51	1.06	0.90	0.76	1.09	2.39	6 of 71
CHROMIUM	<i>3.70</i>	<i>3.15</i>	<i>2.68</i>	<i>3.09</i>	<i>2.95</i>	<i>3.72</i>	<i>6.27</i>	<i>5.11</i>	<i>7.02</i>	<i>3.22</i>	<i>6.23</i>	<i>4.09</i>	4.24	14.29	47 of 71
COPPER	<i>91.39</i>	<i>79.34</i>	<i>111.74</i>	<i>79.01</i>	<i>60.56</i>	<i>77.84</i>	<i>95.59</i>	<i>62.07</i>	<i>76.84</i>	<i>64.32</i>	<i>76.92</i>	<i>68.58</i>	79.36	258.28	71 of 71
HEXAVALENT CHROMIUM	5.43	4.39	4.11	5.68	4.61	4.24	5.62	7.74	7.96	5.86	4.84	4.20	5.29	8.49	0 of 34
IRON	<i>2061.98</i>	<i>1747.76</i>	<i>2428.78</i>	<i>1816.27</i>	<i>1381.94</i>	<i>1600.59</i>	<i>2601.95</i>	<i>1719.60</i>	<i>2282.35</i>	<i>1685.61</i>	<i>2026.47</i>	<i>1533.04</i>	1911.60	6198.82	71 of 71
LEAD	<i>13.49</i>	<i>9.80</i>	<i>17.12</i>	<i>15.07</i>	<i>7.25</i>	<i>10.57</i>	<i>16.27</i>	<i>8.91</i>	<i>10.39</i>	<i>8.05</i>	<i>9.04</i>	<i>8.16</i>	11.27	62.67	70 of 71
MERCURY	<i>0.40</i>	<i>0.23</i>	<i>0.44</i>	<i>0.24</i>	<i>0.17</i>	<i>0.31</i>	<i>0.33</i>	<i>0.35</i>	<i>0.32</i>	<i>0.20</i>	<i>0.32</i>	<i>0.25</i>	0.30	1.55	70 of 71
MOLYBDENUM	<i>3.58</i>	<i>4.27</i>	<i>3.52</i>	<i>6.93</i>	<i>3.65</i>	<i>3.94</i>	<i>3.99</i>	<i>1.64</i>	<i>2.17</i>	<i>2.70</i>	<i>2.96</i>	<i>5.57</i>	3.81	16.38	50 of 75
NICKEL	4.00	<i>3.90</i>	<i>3.71</i>	<i>5.91</i>	<i>4.04</i>	<i>4.42</i>	<i>5.11</i>	<i>3.38</i>	<i>6.45</i>	<i>4.26</i>	<i>5.48</i>	<i>5.14</i>	4.66	15.72	38 of 71
SELENIUM	0.53	0.37	0.39	0.77	<i>0.53</i>	0.35	0.54	0.62	0.67	0.48	0.41	<i>0.43</i>	0.50	2.38	2 of 71
SILVER	<i>3.54</i>	<i>2.04</i>	<i>4.60</i>	<i>4.45</i>	<i>3.03</i>	<i>4.12</i>	<i>3.57</i>	<i>3.00</i>	<i>3.57</i>	<i>4.39</i>	<i>3.18</i>	<i>4.53</i>	3.64	9.57	61 of 71
THALLIUM	0.50	<i>0.49</i>	0.38	<i>0.87</i>	0.41	0.38	<i>0.69</i>	0.69	0.76	0.53	0.45	0.38	0.54	1.79	4 of 71
ZINC	<i>106.11</i>	<i>96.35</i>	<i>129.50</i>	<i>104.56</i>	<i>79.78</i>	<i>107.20</i>	<i>148.68</i>	<i>102.63</i>	<i>139.67</i>	<i>107.94</i>	<i>136.00</i>	<i>105.87</i>	113.62	301.58	71 of 71
Cyanide and Phenols (lbs/day)															
	Jul	Aug	Sep	Oct	Nov	Dec	Jan	Feb	Mar	Apr	May	Jun	Average	Maximum	Times
CYANIDE	4.94	3.99	3.74	5.17	4.19	3.85	5.11	7.04	7.23	5.33	4.40	3.81	4.81	7.71	0 of 34
TOTAL PHENOLS	<i>23.47</i>	<i>30.25</i>	<i>29.96</i>	<i>35.03</i>	<i>35.82</i>	<i>32.67</i>	<i>42.69</i>	<i>25.94</i>	<i>8.23</i>	<i>11.17</i>	<i>36.18</i>	<i>48.70</i>	30.73	59.66	30 of 33
Oil and Grease, Petroleum Hydrocarbons, and Surfactants (lbs/day)															
	Jul	Aug	Sep	Oct	Nov	Dec	Jan	Feb	Mar	Apr	May	Jun	Average	Maximum	Times
PETROLEUM HYDROCARBON	793	980	720	1581	683	549	1128	772	877	1741	874	784	943	2578	34 of 34
TOTAL PETROLEUM HYDROCARBON	3184	2446	1967	3626	2622	2371	6593	3274	2545	5130	2337	4610	3385	9398	34 of 34
FATS OIL AND GREASE	44196	29656	28314	37604	29012	31406	31133	31688	40725	40515	38464	25723	33979	117199	72 of 72
MBAS	4466	3996	3244	3381	3545	4227	4510	3997	4128	3983	4125	4345	4014	5647	33 of 33

Table A-7 Deer Island Influent Loadings (South System), Fiscal Year 1999, cont.

Organochlorine Pesticides and PCBs (lbs/day)	Jul	Aug	Sep	Oct	Nov	Dec	Jan	Feb	Mar	Apr	May	Jun	Average	Maximum	Times Detected
4,4'-DDD	0.002	0.002	0.002	0.002	0.002	0.002	0.002	0.003	0.003	0.002	0.002	0.002	0.002	0.003	0 of 33
4,4'-DDE	0.002	0.002	0.002	0.002	0.002	0.002	0.002	0.003	0.003	0.002	0.002	0.002	0.002	0.003	0 of 33
4,4'-DDT	0.002	0.002	0.002	0.002	0.002	0.002	0.002	0.003	0.003	0.002	0.002	0.002	0.002	0.003	0 of 33
ALDRIN	0.002	0.002	0.002	0.002	0.002	0.002	0.002	0.003	0.003	0.002	0.002	0.002	0.002	0.003	0 of 33
ALPHA-BHC	0.002	0.002	0.002	0.002	0.002	0.002	0.002	0.003	0.003	0.002	0.002	0.002	0.002	0.003	0 of 33
ALPHA-CHLORDANE	0.002	0.002	0.006	0.002	0.002	0.002	0.002	0.003	0.003	0.002	0.002	0.002	0.003	0.015	1 of 33
AROCLOR-1016	0.054	0.041	0.043	0.055	0.048	0.054	0.058	0.078	0.085	0.061	0.047	0.040	0.055	0.086	0 of 33
AROCLOR-1221	0.109	0.082	0.086	0.074	0.096	0.107	0.117	0.157	0.171	0.123	0.093	0.080	0.107	0.172	0 of 33
AROCLOR-1232	0.054	0.041	0.043	0.055	0.048	0.054	0.058	0.078	0.085	0.061	0.047	0.040	0.055	0.086	0 of 33
AROCLOR-1242	0.054	0.041	0.043	0.055	0.048	0.054	0.058	0.078	0.085	0.061	0.047	0.040	0.055	0.086	0 of 33
AROCLOR-1248	0.054	0.041	0.043	0.055	0.048	0.054	0.058	0.078	0.085	0.061	0.047	0.040	0.055	0.086	0 of 33
AROCLOR-1254	0.054	0.041	0.043	0.055	0.048	0.054	0.058	0.078	0.085	0.061	0.047	0.040	0.055	0.086	0 of 33
AROCLOR-1260	0.054	0.041	0.043	0.055	0.048	0.054	0.058	0.078	0.085	0.061	0.047	0.040	0.055	0.086	0 of 33
BETA-BHC	0.002	0.002	0.002	0.002	0.002	0.002	0.002	0.003	0.003	0.002	0.002	0.002	0.002	0.003	0 of 33
CHLORDANE (TECHNICAL)	0.054	0.041	0.043	0.055	0.048	0.054	0.058	0.078	0.085	0.061	0.047	0.040	0.055	0.086	0 of 33
DELTA-BHC	0.002	0.002	0.002	0.002	0.002	0.007	0.002	0.003	0.003	0.002	0.002	0.002	0.003	0.018	1 of 33
DIELDRIN	0.002	0.002	0.002	0.002	0.002	0.002	0.002	0.003	0.003	0.002	0.002	0.002	0.002	0.003	0 of 33
ENDOSULFAN I	0.002	0.002	0.002	0.002	0.002	0.002	0.002	0.003	0.003	0.002	0.002	0.002	0.002	0.003	0 of 33
ENDOSULFAN II	0.002	0.002	0.002	0.002	0.002	0.002	0.002	0.003	0.003	0.002	0.002	0.002	0.002	0.003	0 of 33
ENDOSULFAN SULFATE	0.002	0.002	0.002	0.002	0.002	0.002	0.002	0.003	0.003	0.002	0.002	0.002	0.002	0.003	0 of 33
ENDRIN	0.002	0.002	0.002	0.002	0.002	0.002	0.002	0.003	0.003	0.002	0.002	0.002	0.002	0.003	0 of 33
ENDRIN ALDEHYDE	0.002	0.002	0.002	0.002	0.002	0.002	0.002	0.003	0.003	0.002	0.002	0.002	0.002	0.003	0 of 33
ENDRIN KETONE	0.002	0.002	0.002	0.002	0.002	0.002	0.002	0.003	0.003	0.002	0.002	0.002	0.002	0.003	0 of 33
GAMMA-BHC (LINDANE)	0.002	0.002	0.002	0.002	0.002	0.018	0.002	0.003	0.003	0.002	0.002	0.005	0.004	0.032	3 of 33
GAMMA-CHLORDANE	0.002	0.002	0.005	0.002	0.002	0.002	0.002	0.003	0.003	0.002	0.002	0.002	0.002	0.011	1 of 33
HEPTACHLOR	0.002	0.002	0.002	0.002	0.002	0.002	0.002	0.003	0.003	0.002	0.002	0.002	0.002	0.003	0 of 33
HEPTACHLOR EPOXIDE	0.002	0.002	0.002	0.002	0.002	0.002	0.002	0.003	0.003	0.002	0.002	0.002	0.002	0.003	0 of 33
METHOXYCHLOR	0.022	0.016	0.017	0.022	0.019	0.021	0.023	0.031	0.034	0.024	0.019	0.016	0.022	0.034	0 of 33
TOXAPHENE	0.054	0.041	0.043	0.055	0.048	0.054	0.058	0.078	0.085	0.061	0.047	0.040	0.055	0.086	0 of 33

Table A-7 Deer Island Influent Loadings (South System), Fiscal Year 1999, cont.

Semivolatile Organics (lbs/day)	Jul	Aug	Sep	Oct	Nov	Dec	Jan	Feb	Mar	Apr	May	Jun	Average	Maximum	Times Detected
1,2,4-TRICHLOROBENZENE	1.12	0.83	1.14	1.07	0.89	1.28	1.26	1.54	1.76	1.66	0.98	0.82	1.19	2.47	0 of 33
1,2-DICHLOROBENZENE	1.12	0.83	1.14	1.07	0.89	1.28	1.26	1.54	1.76	1.66	0.98	0.82	1.19	2.47	0 of 33
1,2-DIPHENYLHYDRAZINE (AS AZOB)	1.12	0.83	1.14	1.07	0.89	1.28	1.26	1.54	1.76	1.66	0.98	0.82	1.19	2.47	0 of 33
1,3-DICHLOROBENZENE	1.12	0.83	1.14	1.07	0.89	1.28	1.26	1.54	1.76	1.66	0.98	0.82	1.19	2.47	0 of 33
1,4-DICHLOROBENZENE	1.12	0.83	1.14	1.07	0.89	1.28	1.26	1.54	1.76	1.66	0.98	0.82	1.19	2.47	0 of 33
2,2'-OXYBIS(1-CHLOROPROPANE)	1.12	0.83	1.14	1.07	0.89	1.28	1.26	1.54	1.76	1.66	0.98	0.82	1.19	2.47	0 of 33
2,4,5-TRICHLOROPHENOL	1.12	0.83	1.14	1.07	0.89	1.28	1.26	1.54	1.76	1.66	0.98	0.82	1.19	2.47	0 of 33
2,4,6-TRICHLOROPHENOL	1.12	0.83	1.14	1.07	0.89	1.28	1.26	1.54	1.76	1.66	0.98	0.82	1.19	2.47	0 of 33
2,4-DICHLOROPHENOL	1.12	0.83	1.14	1.07	0.89	1.28	1.26	1.54	1.76	1.66	0.98	0.82	1.19	2.47	0 of 33
2,4-DIMETHYLPHENOL	1.12	0.83	1.14	1.07	0.89	1.28	1.26	1.54	1.76	1.66	0.98	0.82	1.19	2.47	0 of 33
2,4-DINITROPHENOL	2.23	1.66	2.28	2.13	1.78	2.56	2.53	3.09	3.52	3.32	1.97	1.64	2.38	4.94	0 of 33
2,4-DINITROTOLUENE	1.12	0.83	1.14	1.07	0.89	1.28	1.26	1.54	1.76	1.66	0.98	0.82	1.19	2.47	0 of 33
2,6-DINITROTOLUENE	1.12	0.83	1.14	1.07	0.89	1.28	1.26	1.54	1.76	1.66	0.98	0.82	1.19	2.47	0 of 33
2-CHLORONAPHTHALENE	1.12	0.83	1.14	1.07	0.89	1.28	1.26	1.54	1.76	1.66	0.98	0.82	1.19	2.47	0 of 33
2-CHLOROPHENOL	1.12	0.83	1.14	1.07	0.89	1.28	1.26	1.54	1.76	1.66	0.98	0.82	1.19	2.47	0 of 33
2-METHYL-4,6-DINITROPHENOL	11.16	8.28	11.42	10.67	8.89	12.81	12.63	15.45	17.60	16.59	9.83	8.20	11.88	24.72	0 of 33
2-METHYLNAPHTHALENE	1.12	0.83	1.14	1.07	0.89	1.28	1.26	1.54	1.76	1.66	0.98	0.82	1.19	2.47	0 of 33
2-METHYLPHENOL	1.12	0.83	1.14	1.07	0.89	1.28	1.26	1.54	1.76	1.66	0.98	0.82	1.19	2.47	0 of 33
2-NITROANILINE	1.12	0.83	1.14	1.07	0.89	1.28	1.26	1.54	1.76	1.66	0.98	0.82	1.19	2.47	0 of 33
2-NITROPHENOL	1.12	0.83	1.14	1.07	0.89	1.28	1.26	1.54	1.76	1.66	0.98	0.82	1.19	2.47	0 of 33
3,3'-DICHLOROBENZIDINE	2.23	1.66	2.28	2.13	1.78	2.56	2.53	3.09	3.52	3.32	1.97	1.64	2.38	4.94	0 of 33
3-NITROANILINE	1.12	0.83	1.14	1.07	0.89	1.28	1.26	1.54	1.76	1.66	0.98	0.82	1.19	2.47	0 of 33
4-BROMOPHENYL PHENYL ETHER	1.12	0.83	1.14	1.07	0.89	1.28	1.26	1.54	1.76	1.66	0.98	0.82	1.19	2.47	0 of 33
4-CHLORO-3-METHYLPHENOL	1.12	0.83	1.14	1.07	0.89	1.28	1.26	1.54	1.76	1.66	0.98	0.82	1.19	2.47	0 of 33
4-CHLOROANILINE	1.12	0.83	1.14	1.07	0.89	1.28	1.26	1.54	1.76	1.66	0.98	0.82	1.19	2.47	0 of 33
4-CHLOROPHENYL PHENYL ETHER	1.12	0.83	1.14	1.07	0.89	1.28	1.26	1.54	1.76	1.66	0.98	0.82	1.19	2.47	0 of 33
4-METHYLPHENOL (INCLUDES 3-MET)	10.82	14.56	21.22	12.54	14.24	24.16	19.97	5.51	1.76	5.46	15.87	24.13	14.76	42.20	28 of 33
4-NITROANILINE	1.12	0.83	1.14	1.07	0.89	1.28	1.26	1.54	1.76	1.66	0.98	0.82	1.19	2.47	0 of 33
4-NITROPHENOL	2.23	1.66	2.28	2.13	1.78	2.56	2.53	3.09	3.52	3.32	1.97	1.64	2.38	4.94	0 of 33
ACENAPHTHENE	1.12	0.83	1.14	1.07	0.89	1.28	1.26	1.54	1.76	1.66	0.98	0.82	1.19	2.47	0 of 33
ACENAPHTHYLENE	1.12	0.83	1.14	1.07	0.89	1.28	1.26	1.54	1.76	1.66	0.98	0.82	1.19	2.47	0 of 33
ANILINE	1.12	0.83	1.14	1.07	0.89	1.28	1.26	1.54	1.76	1.66	0.98	0.82	1.19	2.47	0 of 33
ANTHRACENE	1.12	0.83	1.14	1.07	0.89	1.28	1.26	1.54	1.76	1.66	0.98	0.82	1.19	2.47	0 of 33
BENZIDINE	5.58	4.14	5.71	5.33	4.45	6.41	6.32	7.72	8.80	8.30	4.91	4.10	5.94	12.36	0 of 33
BENZO(A)ANTHRACENE	1.12	0.83	1.14	1.07	0.89	1.28	1.26	1.54	1.76	1.66	0.98	0.82	1.19	2.47	0 of 33

Table A-7 Deer Island Influent Loadings (South System), Fiscal Year 1999, cont.

Semivolatile Organics (lbs/day)	Jul	Aug	Sep	Oct	Nov	Dec	Jan	Feb	Mar	Apr	May	Jun	Average	Maximum	Times Detected
BENZO(A)PYRENE	1.12	0.83	1.14	1.07	0.89	1.28	1.26	1.54	1.76	1.66	0.98	0.82	1.19	2.47	0 of 33
BENZO(B)FLUORANTHENE	1.12	0.83	1.14	1.07	0.89	1.28	1.26	1.54	1.76	1.66	0.98	0.82	1.19	2.47	0 of 33
BENZO(GHI)PERYLENE	1.12	0.83	1.14	1.07	0.89	1.28	1.26	1.54	1.76	1.66	0.98	0.82	1.19	2.47	0 of 33
BENZO(K)FLUORANTHENE	1.12	0.83	1.14	1.07	0.89	1.28	1.26	1.54	1.76	1.66	0.98	0.82	1.19	2.47	0 of 33
BENZOIC ACID	2.23	6.79	10.06	6.55	1.78	29.10	11.28	3.09	3.52	3.32	16.94	1.64	8.84	50.03	13 of 33
BENZYL ALCOHOL	9.05	8.73	5.35	8.35	5.40	8.46	9.33	1.54	42.00	7.54	8.98	9.93	9.64	49.47	24 of 33
BIS(2-CHLOROETHOXY)METHANE	1.12	0.83	1.14	1.07	0.89	1.28	1.26	1.54	1.76	1.66	0.98	0.82	1.19	2.47	0 of 33
BIS(2-CHLOROETHYL)ETHER	1.12	0.83	1.14	1.07	0.89	1.28	1.26	1.54	1.76	1.66	0.98	0.82	1.19	2.47	0 of 33
BIS(2-ETHYLHEXYL)PHTHALATE	1.12	2.68	10.67	7.42	5.84	9.23	12.27	16.09	9.93	6.95	2.25	6.90	7.64	38.23	24 of 33
BUTYL BENZYL PHTHALATE	1.12	0.83	1.14	1.07	0.89	1.28	1.26	1.54	1.76	1.66	0.98	0.82	1.19	2.47	0 of 33
CHRYSENE	1.12	0.83	1.14	1.07	0.89	1.28	1.26	1.54	1.76	1.66	0.98	0.82	1.19	2.47	0 of 33
DIBENZO(A,H)ANTHRACENE	1.12	0.83	1.14	1.07	0.89	1.28	1.26	1.54	1.76	1.66	0.98	0.82	1.19	2.47	0 of 33
DIBENZOFURAN	1.12	0.83	1.14	1.07	0.89	1.28	1.26	1.54	1.76	1.66	0.98	0.82	1.19	2.47	0 of 33
DIETHYL PHTHALATE	1.12	0.83	1.14	1.07	0.89	1.28	1.26	1.54	1.76	1.66	0.98	0.82	1.19	2.47	0 of 33
DIMETHYL PHTHALATE	1.12	0.83	1.14	1.07	0.89	1.28	1.26	1.54	1.76	1.66	0.98	0.82	1.19	2.47	0 of 33
DI-N-BUTYLPHTHALATE	1.12	1.98	5.78	2.61	0.89	1.28	1.26	1.54	1.76	1.66	1.96	5.37	2.34	11.93	8 of 33
DI-N-OCTYLPHTHALATE	1.12	0.83	1.14	1.07	0.89	1.28	1.26	1.54	1.76	1.66	0.98	0.82	1.19	2.47	0 of 33
FLUORANTHENE	1.12	0.83	1.14	1.07	0.89	1.28	1.26	1.54	1.76	1.66	0.98	0.82	1.19	2.47	0 of 33
FLUORENE	1.12	0.83	1.14	1.07	0.89	1.28	1.26	1.54	1.76	1.66	0.98	0.82	1.19	2.47	0 of 33
HEXACHLOROBENZENE	1.12	0.83	1.14	1.07	0.89	1.28	1.26	1.54	1.76	1.66	0.98	0.82	1.19	2.47	0 of 33
HEXACHLOROBUTADIENE	1.12	0.83	1.14	1.07	0.89	1.28	1.26	1.54	1.76	1.66	0.98	0.82	1.19	2.47	0 of 33
HEXACHLOROCYCLOPENTADIENE	5.58	4.14	5.71	5.33	4.45	6.41	6.32	7.72	8.80	8.30	4.91	4.10	5.94	12.36	0 of 33
HEXACHLOROETHANE	1.12	0.83	1.14	1.07	0.89	1.28	1.26	1.54	1.76	1.66	0.98	0.82	1.19	2.47	0 of 33
INDENO(1,2,3-CD)PYRENE	1.12	0.83	1.14	1.07	0.89	1.28	1.26	1.54	1.76	1.66	0.98	0.82	1.19	2.47	0 of 33
ISOPHORONE	1.12	0.83	1.14	1.07	0.89	1.28	1.26	1.54	1.76	1.66	0.98	0.82	1.19	2.47	0 of 33
NAPHTHALENE	1.12	0.83	1.14	1.07	0.89	1.28	1.26	1.54	1.76	1.66	0.98	0.82	1.19	2.47	0 of 33
NITROBENZENE	1.12	0.83	1.14	1.07	0.89	1.28	1.26	1.54	1.76	1.66	0.98	0.82	1.19	2.47	0 of 33
N-NITROSODIMETHYLAMINE	1.12	0.83	1.14	1.07	0.89	1.28	1.26	1.54	1.76	1.66	0.98	0.82	1.19	2.47	0 of 33
N-NITROSDI-N-PROPYLAMINE	1.12	0.83	1.14	1.07	0.89	1.28	1.26	1.54	1.76	1.66	0.98	0.82	1.19	2.47	0 of 33
N-NITROSODIPHENYLAMINE	1.12	0.83	1.14	1.07	0.89	1.28	1.26	1.54	1.76	1.66	0.98	0.82	1.19	2.47	0 of 33
PENTACHLOROPHENOL	5.58	4.14	5.71	3.20	2.67	3.84	3.79	4.63	5.28	4.98	2.95	2.46	4.06	8.86	0 of 33
PHENANTHRENE	0.11	0.08	0.11	0.11	0.09	0.13	0.13	0.15	0.18	0.17	0.10	0.08	0.12	0.25	0 of 33
PHENOL	2.23	6.04	2.28	3.27	4.01	5.36	5.68	3.09	3.52	3.32	3.85	6.03	4.15	14.76	11 of 33
PYRENE	1.12	0.83	1.14	1.07	0.89	1.28	1.26	1.54	1.76	1.66	0.98	0.82	1.19	2.47	0 of 33

Table A-7 Deer Island Influent Loadings (South System), Fiscal Year 1999, cont.

Volatile Organics (lbs/day)													Times		
	Jul	Aug	Sep	Oct	Nov	Dec	Jan	Feb	Mar	Apr	May	Jun	Average	Maximum	Detected
1,1,1-TRICHLOROETHANE	0.49	0.40	0.37	0.52	0.42	0.39	0.51	0.70	0.72	0.53	0.44	0.38	0.48	0.77	0 of 34
1,1,2,2-TETRACHLOROETHANE	0.49	0.40	0.37	0.52	0.42	0.39	0.51	0.70	0.72	0.53	0.44	0.38	0.48	0.77	0 of 34
1,1,2-TRICHLOROETHANE	0.49	0.40	0.37	0.52	0.42	0.39	0.51	0.70	0.72	0.53	0.44	0.38	0.48	0.77	0 of 34
1,1-DICHLOROETHANE	0.49	0.40	0.37	0.52	0.42	0.39	0.51	0.70	0.72	0.53	0.44	0.38	0.48	0.77	0 of 34
1,1-DICHLOROETHENE	0.49	0.40	0.37	0.52	0.42	0.39	0.51	0.70	0.72	0.53	0.44	0.38	0.48	0.77	0 of 34
1,2-DICHLOROBENZENE	0.49	0.40	0.37	0.52	0.42	0.39	0.51	0.70	0.72	0.53	0.44	0.38	0.48	0.77	0 of 34
1,2-DICHLOROETHANE	0.49	0.40	0.37	0.52	0.42	0.39	0.51	0.70	0.72	0.53	0.44	0.38	0.48	0.77	0 of 34
1,2-DICHLOROPROPANE	0.49	0.40	0.37	0.52	0.42	0.39	0.51	0.70	0.72	0.53	0.44	0.38	0.48	0.77	0 of 34
1,3-DICHLOROBENZENE	0.49	0.40	0.37	0.52	0.42	0.39	0.51	0.70	0.72	0.53	0.44	0.38	0.48	0.77	0 of 34
1,4-DICHLOROBENZENE	3.08	1.56	1.04	0.52	0.42	0.39	0.51	0.70	0.72	0.53	0.44	1.09	0.86	3.35	6 of 34
2-BUTANONE	0.49	5.01	7.10	8.47	9.17	3.03	6.57	9.51	0.72	8.40	5.00	6.93	6.07	15.87	23 of 34
2-CHLOROETHYL VINYL ETHER	0.49	0.40	0.37	0.52	0.42	0.39	0.51	0.70	0.72	0.53	0.44	0.38	0.48	0.77	0 of 34
2-HEXANONE	0.49	0.40	0.37	0.52	0.42	0.39	0.51	0.70	0.72	0.53	0.44	0.38	0.48	0.77	0 of 34
4-METHYL-2-PENTANONE	0.49	0.40	0.37	0.52	0.42	0.39	0.51	0.70	0.72	0.53	0.44	0.38	0.48	0.77	0 of 34
ACETONE	224.93	130.73	191.92	171.33	132.78	78.81	114.59	141.57	135.24	166.39	117.08	98.30	138.14	282.34	34 of 34
ACROLEIN	0.49	0.40	0.37	0.52	0.42	0.39	0.51	0.70	0.72	0.53	0.44	0.38	0.48	0.77	0 of 34
ACRYLONITRILE	0.49	0.40	0.37	0.52	0.42	0.39	0.51	0.70	0.72	0.53	0.44	0.38	0.48	0.77	0 of 34
BENZENE	0.49	0.40	0.37	0.52	0.42	0.39	0.51	0.70	0.72	0.53	0.44	0.38	0.48	0.77	0 of 34
BROMODICHLOROMETHANE	0.49	0.40	0.37	0.52	0.42	0.39	0.51	0.70	0.72	0.53	0.44	0.38	0.48	0.77	0 of 34
BROMOFORM	0.49	0.40	0.37	0.52	0.42	0.39	0.51	0.70	0.72	0.53	0.44	0.38	0.48	0.77	0 of 34
BROMOMETHANE	0.49	0.40	0.37	0.52	0.42	0.39	0.51	0.70	0.72	0.53	0.44	0.38	0.48	0.77	0 of 34
CARBON DISULFIDE	2.17	0.40	0.37	0.52	0.99	1.32	1.86	0.70	0.72	3.14	0.44	6.14	1.57	8.19	10 of 34
CARBON TETRACHLORIDE	0.49	0.40	0.37	0.52	0.42	0.39	0.51	0.70	0.72	0.53	0.44	0.38	0.48	0.77	0 of 34
CHLOROBENZENE	0.49	0.40	0.37	0.52	0.42	0.39	0.51	0.70	0.72	0.53	0.44	0.38	0.48	0.77	0 of 34
CHLOROETHANE	0.49	0.40	0.37	0.52	0.42	0.39	0.51	0.70	0.72	0.53	0.44	0.38	0.48	0.77	0 of 34
CHLOROFORM	5.86	4.03	4.54	4.66	4.18	5.75	4.08	4.63	4.84	5.97	6.82	5.65	5.13	8.12	34 of 34
CHLOROMETHANE	0.49	0.40	0.37	0.52	0.42	0.39	0.51	0.70	0.72	0.53	0.44	0.38	0.48	0.77	0 of 34
CIS-1,2-DICHLOROETHENE	0.49	0.40	0.37	0.52	0.42	0.39	0.51	0.70	0.72	0.53	0.44	0.38	0.48	0.77	0 of 34
CIS-1,3-DICHLOROPROPENE	0.49	0.40	0.37	0.52	0.42	0.39	0.51	0.70	0.72	0.53	0.44	0.38	0.48	0.77	0 of 34
DIBROMOCHLOROMETHANE	0.49	0.40	0.37	0.52	0.42	0.39	0.51	0.70	0.72	0.53	0.44	0.38	0.48	0.77	0 of 34
ETHYLBENZENE	0.49	0.40	0.37	0.52	0.42	0.39	0.51	0.70	0.72	0.53	0.44	0.38	0.48	0.77	0 of 34
M,P-XYLENE	0.49	0.40	0.37	0.52	0.42	0.39	0.51	0.70	0.72	0.53	0.44	1.34	0.57	3.27	1 of 34
METHYLENE CHLORIDE	3.44	1.88	9.32	4.31	20.60	2.82	3.06	2.94	0.72	20.06	17.65	8.09	8.64	45.23	21 of 34
O-XYLENE	0.49	0.40	0.37	0.52	0.42	0.39	0.51	0.70	0.72	0.53	0.44	0.38	0.48	0.77	0 of 34
STYRENE	0.49	0.40	0.37	0.52	0.42	0.39	0.51	0.70	0.72	0.53	0.44	0.38	0.48	0.77	0 of 34
TETRACHLOROETHENE	9.66	5.76	1.85	2.63	4.44	0.94	1.53	1.73	0.72	2.94	3.05	1.72	2.97	15.81	23 of 34
TOLUENE	3.35	3.59	2.63	5.03	2.81	4.99	4.02	0.70	0.72	2.15	5.10	5.48	3.46	9.34	27 of 34
TRANS-1,2-DICHLOROETHENE	0.49	0.40	0.37	0.52	0.42	0.39	0.51	0.70	0.72	0.53	0.44	0.38	0.48	0.77	0 of 34

Table A-7 Deer Island Influent Loadings (South System), Fiscal Year 1999, cont.

Volatile Organics (lbs/day)															Times
	Jul	Aug	Sep	Oct	Nov	Dec	Jan	Feb	Mar	Apr	May	Jun	Average	Maximum	Detected
TRANS-1,3-DICHLOROPROPENE	0.49	0.40	0.37	0.52	0.42	0.39	0.51	0.70	0.72	0.53	0.44	0.38	0.48	0.77	0 of 34
TRICHLOROETHENE	0.49	0.40	0.37	0.52	0.42	0.93	0.51	0.70	0.72	0.53	0.44	0.38	0.53	2.01	1 of 34
TRICHLOROFLUOROMETHANE	0.49	0.40	0.37	0.52	0.42	0.39	0.51	0.70	0.72	0.53	0.44	0.38	0.48	0.77	0 of 34
VINYL ACETATE	0.49	0.40	0.37	0.52	0.42	0.39	0.51	0.70	0.72	0.53	0.44	0.38	0.48	0.77	0 of 34
VINYL CHLORIDE	0.49	0.40	0.37	0.52	0.42	0.39	0.51	0.70	0.72	0.53	0.44	0.38	0.48	0.77	0 of 34

Notes:

Results in ***bold italics*** indicate one or more detects in the month.

Yearly averages are calculated from individual results collected in the fiscal year.

Non-detected compounds are assumed to equal one half of the detection limit for metals and inorganics and one tenth of the reporting limit for organic compounds.

Table A-8 Deer Island Effluent Characterization, Fiscal Year 1999

Metals (ug/L)															Times
	Jul	Aug	Sep	Oct	Nov	Dec	Jan	Feb	Mar	Apr	May	Jun	Average	Maximum	Detected
ANTIMONY	20.00	20.00	20.00	20.00	<i>12.01</i>	7.50	8.11	12.64	13.27	7.50	7.50	7.12	13.06	20.00	1 of 77
ARSENIC	<i>0.60</i>	<i>0.80</i>	0.40	<i>0.74</i>	<i>0.59</i>	<i>0.84</i>	<i>0.78</i>	0.40	<i>0.73</i>	<i>0.70</i>	<i>0.82</i>	<i>0.48</i>	0.66	2.12	24 of 78
BERYLLIUM	0.50	0.50	0.50	0.50	0.32	0.25	0.25	0.34	0.25	0.25	0.25	0.25	0.35	0.50	0 of 77
BORON	<i>188.29</i>	<i>205.48</i>	<i>273.02</i>	<i>244.36</i>	<i>342.22</i>	<i>315.69</i>	<i>159.72</i>	125.00	125.00	<i>202.38</i>	<i>201.99</i>	<i>306.76</i>	218.84	445.00	46 of 77
CADMIUM	1.00	1.00	1.00	<i>1.16</i>	<i>1.18</i>	1.00	1.00	1.00	1.00	1.00	1.00	1.00	1.03	2.36	2 of 77
CHROMIUM	1.50	<i>1.73</i>	<i>1.77</i>	<i>1.76</i>	<i>2.32</i>	<i>2.31</i>	<i>4.77</i>	<i>2.90</i>	<i>5.84</i>	<i>2.41</i>	<i>3.74</i>	<i>3.41</i>	2.92	8.68	20 of 77
COPPER	<i>14.86</i>	<i>12.90</i>	<i>12.52</i>	<i>19.43</i>	<i>13.85</i>	<i>18.29</i>	<i>24.48</i>	<i>22.63</i>	<i>20.36</i>	<i>22.16</i>	<i>22.38</i>	<i>13.39</i>	18.29	33.30	66 of 77
HEXAVALENT CHROMIUM	5.50	5.50	5.50	5.50	5.50	5.50	5.50	5.50	5.50	5.50	5.50	5.50	5.50	5.50	0 of 34
IRON	<i>377.09</i>	<i>451.90</i>	<i>535.66</i>	<i>588.69</i>	<i>349.62</i>	<i>439.04</i>	<i>813.97</i>	<i>624.22</i>	<i>609.34</i>	<i>524.42</i>	<i>631.71</i>	<i>335.15</i>	529.52	1210.00	78 of 78
LEAD	<i>1.79</i>	<i>2.84</i>	<i>1.63</i>	<i>3.16</i>	1.20	1.20	<i>5.67</i>	<i>1.72</i>	<i>6.11</i>	<i>2.18</i>	<i>5.16</i>	<i>1.20</i>	2.91	16.80	21 of 77
MERCURY	<i>0.05</i>	<i>0.05</i>	<i>0.03</i>	<i>0.06</i>	<i>0.03</i>	<i>0.04</i>	<i>0.06</i>	<i>0.07</i>	<i>0.05</i>	<i>0.04</i>	<i>0.06</i>	<i>0.01</i>	0.05	0.17	63 of 77
MOLYBDENUM	<i>6.32</i>	<i>5.66</i>	<i>5.60</i>	<i>4.78</i>	<i>5.23</i>	<i>4.90</i>	<i>5.62</i>	<i>4.38</i>	<i>3.79</i>	<i>5.48</i>	<i>7.14</i>	<i>6.64</i>	5.43	10.40	66 of 84
NICKEL	4.00	4.00	4.00	4.00	<i>3.54</i>	<i>3.48</i>	<i>2.87</i>	<i>5.00</i>	<i>3.09</i>	<i>2.83</i>	<i>6.45</i>	<i>3.58</i>	3.88	17.30	30 of 77
SELENIUM	0.65	0.51	<i>1.04</i>	0.99	0.45	0.45	0.45	0.45	0.45	0.45	0.45	<i>0.62</i>	0.57	4.10	2 of 77
SILVER	<i>1.41</i>	<i>0.59</i>	<i>0.72</i>	<i>1.22</i>	<i>1.16</i>	<i>1.35</i>	<i>1.00</i>	<i>1.63</i>	<i>1.48</i>	<i>2.18</i>	<i>1.92</i>	<i>1.39</i>	1.33	3.74	27 of 77
THALLIUM	<i>0.57</i>	<i>0.72</i>	0.50	<i>0.64</i>	0.50	0.50	0.50	0.50	0.50	0.50	0.50	0.50	0.54	1.64	3 of 77
ZINC	<i>21.84</i>	<i>23.64</i>	<i>19.31</i>	<i>32.76</i>	<i>20.91</i>	<i>25.11</i>	<i>51.25</i>	<i>52.85</i>	<i>52.40</i>	<i>38.68</i>	<i>48.18</i>	<i>27.54</i>	35.15	96.00	72 of 75

Cyanide and Phenols (ug/L)															Times
	Jul	Aug	Sep	Oct	Nov	Dec	Jan	Feb	Mar	Apr	May	Jun	Average	Maximum	Detected
CYANIDE	5.00	5.00	5.00	5.00	5.00	5.00	5.00	5.00	5.00	5.00	5.00	5.00	5.00	5.00	0 of 34
TOTAL PHENOLS	<i>7.06</i>	<i>7.35</i>	1.00	1.00	1.00	<i>7.36</i>	<i>6.40</i>	<i>5.88</i>	<i>4.09</i>	1.00	1.00	<i>5.17</i>	4.20	22.50	9 of 37

Oil and Grease, Petroleum Hydrocarbons, and Surfactants (mg/L)															Times
	Jul	Aug	Sep	Oct	Nov	Dec	Jan	Feb	Mar	Apr	May	Jun	Average	Maximum	Detected
PETROLEUM HYDROCARBON	<i>0.39</i>	<i>0.26</i>	<i>0.33</i>	<i>0.21</i>	<i>0.27</i>	<i>0.38</i>	<i>0.57</i>	<i>0.39</i>	<i>0.42</i>	<i>0.38</i>	<i>0.25</i>	<i>0.26</i>	0.35	0.99	64 of 69
TOTAL PETROLEUM HYDROCARBON	<i>1.35</i>	<i>0.43</i>	<i>0.53</i>	<i>1.18</i>	<i>2.16</i>	<i>0.90</i>	<i>2.00</i>	<i>1.82</i>	<i>0.64</i>	<i>0.62</i>	0.10	<i>0.23</i>	1.01	6.80	38 of 69
FATS OIL AND GREASE	<i>2.50</i>	<i>1.71</i>	<i>9.55</i>	<i>4.54</i>	<i>8.51</i>	<i>10.58</i>	<i>8.43</i>	<i>9.52</i>	<i>10.73</i>	<i>15.61</i>	<i>9.82</i>	<i>3.79</i>	8.30	28.00	49 of 69
MBAS	<i>1.07</i>	<i>0.85</i>	<i>1.00</i>	<i>0.62</i>	<i>0.87</i>	<i>0.83</i>	<i>2.27</i>	<i>0.67</i>	<i>0.83</i>	<i>1.06</i>	<i>1.13</i>	<i>0.43</i>	0.99	4.08	38 of 38

Table A-8 Deer Island Effluent Characterization, Fiscal Year 1999, cont.

Organochlorine Pesticides and PCBs (ug/L)	Jul	Aug	Sep	Oct	Nov	Dec	Jan	Feb	Mar	Apr	May	Jun	Average	Maximum	Times Detected
4,4'-DDD	0.002	0.002	0.002	0.002	0.002	0.002	0.002	0.002	0.002	0.002	0.002	0.002	0.002	0.003	0 of 37
4,4'-DDE	0.002	0.002	0.002	0.002	0.002	0.002	0.002	0.002	0.002	0.002	0.002	0.002	0.002	0.003	0 of 37
4,4'-DDT	0.002	0.002	0.002	0.002	0.002	0.002	0.002	0.002	0.002	0.002	0.002	0.002	0.002	0.003	0 of 37
ALDRIN	0.002	0.002	0.002	0.002	0.002	0.002	0.002	0.002	0.002	0.002	0.002	0.002	0.002	0.003	0 of 37
ALPHA-BHC	0.002	0.008	0.002	0.002	0.002	0.002	0.002	0.002	0.002	0.002	0.002	0.002	0.003	0.019	1 of 37
ALPHA-CHLORDANE	0.002	0.002	0.002	0.002	0.002	0.002	0.002	0.002	0.002	0.002	0.002	0.002	0.002	0.003	0 of 37
AROCLOR-1016	0.053	0.054	0.053	0.054	0.054	0.050	0.059	0.053	0.058	0.054	0.053	0.054	0.054	0.067	0 of 37
AROCLOR-1221	0.107	0.107	0.106	0.108	0.108	0.101	0.118	0.107	0.117	0.107	0.106	0.108	0.109	0.133	0 of 37
AROCLOR-1232	0.053	0.054	0.053	0.054	0.054	0.050	0.059	0.053	0.058	0.054	0.053	0.054	0.054	0.067	0 of 37
AROCLOR-1242	0.053	0.054	0.053	0.054	0.054	0.050	0.059	0.053	0.058	0.054	0.053	0.054	0.054	0.067	0 of 37
AROCLOR-1248	0.053	0.054	0.053	0.054	0.054	0.050	0.059	0.053	0.058	0.054	0.053	0.054	0.054	0.067	0 of 37
AROCLOR-1254	0.053	0.054	0.053	0.054	0.054	0.050	0.059	0.053	0.058	0.054	0.053	0.054	0.054	0.067	0 of 37
AROCLOR-1260	0.053	0.054	0.053	0.054	0.054	0.050	0.059	0.053	0.058	0.054	0.053	0.054	0.054	0.067	0 of 37
BETA-BHC	0.002	0.006	0.002	0.002	0.002	0.002	0.002	0.002	0.002	0.002	0.002	0.002	0.002	0.014	2 of 37
CHLORDANE (TECHNICAL)	0.053	0.054	0.053	0.054	0.054	0.050	0.059	0.053	0.058	0.054	0.053	0.054	0.054	0.067	0 of 37
DELTA-BHC	0.002	0.002	0.002	0.002	0.002	0.002	0.002	0.002	0.002	0.002	0.002	0.002	0.002	0.003	0 of 37
DIELDRIN	0.002	0.002	0.002	0.002	0.002	0.002	0.002	0.002	0.002	0.002	0.002	0.002	0.002	0.003	0 of 37
ENDOSULFAN I	0.002	0.002	0.002	0.002	0.002	0.002	0.002	0.002	0.002	0.002	0.002	0.002	0.002	0.003	0 of 37
ENDOSULFAN II	0.002	0.002	0.002	0.002	0.002	0.002	0.002	0.002	0.002	0.002	0.002	0.002	0.002	0.003	0 of 37
ENDOSULFAN SULFATE	0.002	0.002	0.002	0.002	0.002	0.002	0.002	0.002	0.002	0.002	0.002	0.002	0.002	0.003	0 of 37
ENDRIN	0.002	0.002	0.002	0.002	0.002	0.002	0.002	0.002	0.002	0.002	0.002	0.002	0.002	0.003	0 of 37
ENDRIN ALDEHYDE	0.002	0.002	0.002	0.002	0.002	0.002	0.002	0.002	0.002	0.002	0.002	0.002	0.002	0.003	0 of 37
ENDRIN KETONE	0.002	0.002	0.002	0.002	0.002	0.002	0.002	0.002	0.002	0.002	0.002	0.002	0.002	0.003	0 of 37
GAMMA-BHC (LINDANE)	0.002	0.004	0.002	0.002	0.002	0.002	0.002	0.002	0.002	0.002	0.002	0.002	0.002	0.009	1 of 37
GAMMA-CHLORDANE	0.002	0.002	0.002	0.002	0.002	0.002	0.002	0.002	0.002	0.002	0.002	0.002	0.002	0.003	0 of 37
HEPTACHLOR	0.002	0.002	0.002	0.002	0.002	0.002	0.002	0.002	0.002	0.002	0.002	0.002	0.002	0.003	0 of 37
HEPTACHLOR EPOXIDE	0.002	0.002	0.002	0.002	0.002	0.002	0.002	0.002	0.002	0.002	0.002	0.002	0.002	0.003	0 of 37
METHOXYCHLOR	0.030	0.021	0.021	0.022	0.022	0.020	0.024	0.021	0.023	0.021	0.021	0.021	0.023	0.049	0 of 37
TOXAPHENE	0.053	0.054	0.053	0.054	0.054	0.050	0.059	0.053	0.058	0.054	0.053	0.054	0.054	0.067	0 of 37

Table A-8 Deer Island Effluent Characterization, Fiscal Year 1999, cont.

Semivolatile Organics (ug/L)													Average	Maximum	Times Detected
	Jul	Aug	Sep	Oct	Nov	Dec	Jan	Feb	Mar	Apr	May	Jun			
1,2,4-TRICHLOROBENZENE	1.05	1.03	1.08	1.13	1.13	1.03	1.14	1.03	1.18	1.48	1.07	1.05	1.12	2.24	0 of 37
1,2-DICHLOROBENZENE	1.05	1.03	1.08	1.13	1.13	1.03	1.14	1.03	1.18	1.48	1.07	1.05	1.12	2.24	0 of 37
1,2-DIPHENYLHYDRAZINE (AS AZOB)	1.05	1.03	1.08	1.13	1.13	1.03	1.14	1.03	1.18	1.48	1.07	1.05	1.12	2.24	0 of 37
1,3-DICHLOROBENZENE	1.05	1.03	1.08	1.13	1.13	1.03	1.14	1.03	1.18	1.48	1.07	1.05	1.12	2.24	0 of 37
1,4-DICHLOROBENZENE	1.05	1.03	1.08	1.13	1.13	1.03	1.14	1.03	1.18	1.48	1.07	1.05	1.12	2.24	0 of 37
2,2'-OXYBIS(1-CHLOROPROPANE)	1.05	1.03	1.08	1.13	1.13	1.03	1.14	1.03	1.18	1.48	1.07	1.05	1.12	2.24	0 of 37
2,4,5-TRICHLOROPHENOL	1.05	1.03	1.08	1.13	1.13	1.03	1.14	1.03	1.18	1.48	1.07	1.05	1.12	2.24	0 of 37
2,4,6-TRICHLOROPHENOL	1.05	1.03	1.08	1.13	1.13	1.03	1.14	1.03	1.18	1.48	1.07	1.05	1.12	2.24	0 of 37
2,4-DICHLOROPHENOL	1.05	1.03	1.08	1.13	1.13	1.03	1.14	1.03	1.18	1.48	1.07	1.05	1.12	2.24	0 of 37
2,4-DIMETHYLPHENOL	1.05	1.03	1.08	1.13	1.13	1.03	1.14	1.03	1.18	1.48	1.07	1.05	1.12	2.24	0 of 37
2,4-DINITROPHENOL	2.09	2.06	2.17	2.26	2.26	2.06	2.28	2.06	2.36	2.96	2.15	2.09	2.24	4.48	0 of 37
2,4-DINITROTOLUENE	1.05	1.03	1.08	1.13	1.13	1.03	1.14	1.03	1.18	1.48	1.07	1.05	1.12	2.24	0 of 37
2,6-DINITROTOLUENE	1.05	1.03	1.08	1.13	1.13	1.03	1.14	1.03	6.02	1.48	1.07	1.05	1.63	16.20	1 of 37
2-CHLORONAPHTHALENE	1.05	1.03	1.08	1.13	1.13	1.03	1.14	1.03	1.18	1.48	1.07	1.05	1.12	2.24	0 of 37
2-CHLOROPHENOL	1.05	1.03	1.08	1.13	1.13	1.03	1.14	1.03	1.18	1.48	1.07	1.05	1.12	2.24	0 of 37
2-METHYL-4,6-DINITROPHENOL	10.47	10.30	10.84	11.32	11.30	10.31	11.38	10.29	11.78	14.78	10.73	10.47	11.18	22.40	0 of 37
2-METHYLNAPHTHALENE	1.05	1.03	1.08	1.13	1.13	1.03	1.14	1.03	1.18	1.48	1.07	1.05	1.12	2.24	0 of 37
2-METHYLPHENOL	1.05	1.03	1.08	1.13	1.13	1.03	1.14	1.03	1.18	1.48	1.07	1.05	1.12	2.24	0 of 37
2-NITROANILINE	1.05	1.03	1.08	1.13	1.13	1.03	1.14	1.03	1.18	1.48	1.07	1.05	1.12	2.24	0 of 37
2-NITROPHENOL	1.05	1.03	1.08	1.13	1.13	1.03	1.14	1.03	1.18	1.48	1.07	1.05	1.12	2.24	0 of 37
3,3'-DICHLOROBENZIDINE	2.09	2.06	2.17	2.26	2.26	2.06	2.28	2.06	2.36	2.96	2.15	2.09	2.24	4.48	0 of 37
3-NITROANILINE	1.05	1.03	1.08	1.13	1.13	1.03	1.14	1.03	1.18	1.48	1.07	1.05	1.12	2.24	0 of 37
4-BROMOPHENYL PHENYL ETHER	1.05	1.03	1.08	1.13	1.13	1.03	1.14	1.03	1.18	1.48	1.07	1.05	1.12	2.24	0 of 37
4-CHLORO-3-METHYLPHENOL	1.05	1.03	1.08	1.13	1.13	1.03	1.14	1.03	1.18	1.48	1.07	1.05	1.12	2.24	0 of 37
4-CHLOROANILINE	1.05	1.03	1.08	1.13	1.13	1.03	1.14	1.03	1.18	1.48	1.07	1.05	1.12	2.24	0 of 37
4-CHLOROPHENYL PHENYL ETHER	1.05	1.03	1.08	1.13	1.13	1.03	1.14	1.03	1.18	1.48	1.07	1.05	1.12	2.24	0 of 37
4-METHYLPHENOL (INCLUDES 3-MET)	1.05	1.03	1.08	1.13	2.54	1.03	4.08	1.03	1.18	1.48	1.07	1.05	1.49	7.71	2 of 37
4-NITROANILINE	1.05	1.03	1.08	1.13	1.13	1.03	1.14	1.03	1.18	1.48	1.07	1.05	1.12	2.24	0 of 37
4-NITROPHENOL	2.09	2.06	2.17	2.26	2.26	2.06	2.28	2.06	2.36	2.96	2.15	2.09	2.24	4.48	0 of 37
ACENAPHTHENE	1.05	1.03	1.08	1.13	1.13	1.03	1.14	1.03	1.18	1.48	1.07	1.05	1.12	2.24	0 of 37
ACENAPHTHYLENE	1.05	1.03	1.08	1.13	1.13	1.03	1.14	1.03	1.18	1.48	1.07	1.05	1.12	2.24	0 of 37
ANILINE	1.05	1.03	1.08	1.13	1.13	1.03	1.14	1.03	1.18	1.48	1.07	1.05	1.12	2.24	0 of 37
ANTHRACENE	1.05	1.03	1.08	1.13	1.13	1.03	1.14	1.03	1.18	1.48	1.07	1.05	1.12	2.24	0 of 37
BENZIDINE	5.23	5.15	5.42	5.66	5.65	5.15	5.69	5.14	5.89	7.39	5.36	5.23	5.59	11.20	0 of 37
BENZO(A)ANTHRACENE	1.05	1.03	1.08	1.13	1.13	1.03	1.14	1.03	1.18	1.48	1.07	1.05	1.12	2.24	0 of 37

Table A-8 Deer Island Effluent Characterization, Fiscal Year 1999, cont.

Semivolatile Organics (ug/L)	Jul	Aug	Sep	Oct	Nov	Dec	Jan	Feb	Mar	Apr	May	Jun	Average	Maximum	Times Detected
BENZO(A)PYRENE	1.05	1.03	1.08	1.13	1.13	1.03	1.14	1.03	1.18	1.48	1.07	1.05	1.12	2.24	0 of 37
BENZO(B)FLUORANTHENE	1.05	1.03	1.08	1.13	1.13	1.03	1.14	1.03	1.18	1.48	1.07	1.05	1.12	2.24	0 of 37
BENZO(GHI)PERYLENE	1.05	1.03	1.08	1.13	1.13	1.03	1.14	1.03	1.18	1.48	1.07	1.05	1.12	2.24	0 of 37
BENZO(K)FLUORANTHENE	1.05	1.03	1.08	1.13	1.13	1.03	1.14	1.03	1.18	1.48	1.07	1.05	1.12	2.24	0 of 37
BENZOIC ACID	2.09	2.06	2.17	2.26	4.52	2.06	2.28	2.06	2.36	2.96	2.15	2.09	2.39	8.94	1 of 37
BENZYL ALCOHOL	1.05	1.03	1.08	1.13	3.87	1.03	1.14	1.03	19.46	1.48	1.07	1.05	3.23	31.20	1 of 37
BIS(2-CHLOROETHOXY)METHANE	1.05	1.03	1.08	1.13	1.13	1.03	1.14	1.03	1.18	1.48	1.07	1.05	1.12	2.24	0 of 37
BIS(2-CHLOROETHYL)ETHER	1.05	1.03	1.08	1.13	1.13	1.03	1.14	1.03	1.18	1.48	1.07	1.05	1.12	2.24	0 of 37
BIS(2-ETHYLHEXYL)PHTHALATE	1.05	1.03	1.08	3.78	8.27	1.03	3.62	1.03	1.18	1.48	1.07	1.05	2.08	22.69	3 of 37
BUTYL BENZYL PHTHALATE	1.05	1.03	1.08	1.13	1.13	1.03	1.14	1.03	1.18	1.48	1.07	1.05	1.12	2.24	0 of 37
CHRYSENE	1.05	1.03	1.08	1.13	1.13	1.03	1.14	1.03	1.18	1.48	1.07	1.05	1.12	2.24	0 of 37
DIBENZO(A,H)ANTHRACENE	1.05	1.03	1.08	1.13	1.13	1.03	1.14	1.03	1.18	1.48	1.07	1.05	1.12	2.24	0 of 37
DIBENZOFURAN	1.05	1.03	1.08	1.13	1.13	1.03	1.14	1.03	1.18	1.48	1.07	1.05	1.12	2.24	0 of 37
DIETHYL PHTHALATE	1.05	1.03	1.08	1.13	1.13	1.03	1.14	3.28	1.18	1.48	1.07	1.05	1.35	7.85	1 of 37
DIMETHYL PHTHALATE	1.05	1.03	1.08	1.13	1.13	1.03	1.14	1.03	1.18	1.48	1.07	1.05	1.12	2.24	0 of 37
DI-N-BUTYLPHTHALATE	1.05	1.03	1.08	1.13	1.13	1.03	1.14	1.03	1.18	1.48	1.07	1.05	1.12	2.24	0 of 37
DI-N-OCTYLPHTHALATE	1.05	1.03	1.08	1.13	1.13	1.03	1.14	1.03	1.18	1.48	1.07	1.05	1.12	2.24	0 of 37
FLUORANTHENE	1.05	1.03	1.08	1.13	1.13	1.03	1.14	1.03	1.18	1.48	1.07	1.05	1.12	2.24	0 of 37
FLUORENE	1.05	1.03	1.08	1.13	1.13	1.03	1.14	1.03	1.18	1.48	1.07	1.05	1.12	2.24	0 of 37
HEXACHLOROBENZENE	1.05	1.03	1.08	1.13	1.13	1.03	1.14	1.03	1.18	1.48	1.07	1.05	1.12	2.24	0 of 37
HEXACHLOROBUTADIENE	1.05	1.03	1.08	1.13	1.13	1.03	1.14	1.03	1.18	1.48	1.07	1.05	1.12	2.24	0 of 37
HEXACHLOROCYCLOPENTADIENE	5.23	5.15	5.42	5.66	5.65	5.15	5.69	5.14	5.89	7.39	5.36	5.23	5.59	11.20	0 of 37
HEXACHLOROETHANE	1.05	1.03	1.08	1.13	1.13	1.03	1.14	1.03	1.18	1.48	1.07	1.05	1.12	2.24	0 of 37
INDENO(1,2,3-CD)PYRENE	1.05	1.03	1.08	1.13	1.13	1.03	1.14	1.03	1.18	1.48	1.07	1.05	1.12	2.24	0 of 37
ISOPHORONE	1.05	1.03	1.08	1.13	1.13	1.03	1.14	1.03	1.18	1.48	1.07	1.05	1.12	2.24	0 of 37
NAPHTHALENE	1.05	1.03	1.08	1.13	1.13	1.03	1.14	1.03	1.18	1.48	1.07	1.05	1.12	2.24	0 of 37
NITROBENZENE	1.05	1.03	1.08	1.13	1.13	1.03	1.14	1.03	1.18	1.48	1.07	1.05	1.12	2.24	0 of 37
N-NITROSODIMETHYLAMINE	1.05	1.03	1.08	1.13	1.13	1.03	1.14	1.03	1.18	1.48	1.07	1.05	1.12	2.24	0 of 37
N-NITROSODI-N-PROPYLAMINE	1.05	1.03	1.08	1.13	1.13	1.03	1.14	1.03	1.18	1.48	1.07	1.05	1.12	2.24	0 of 37
N-NITROSODIPHENYLAMINE	1.05	1.03	1.08	1.13	1.13	1.03	1.14	1.03	1.18	1.48	1.07	1.05	1.12	2.24	0 of 37
PENTACHLOROPHENOL	5.23	5.15	5.42	5.05	3.39	3.09	3.41	3.09	3.53	4.44	3.22	3.14	4.03	6.72	0 of 37
PHENANTHRENE	0.10	0.10	0.11	0.11	0.11	0.10	0.11	0.10	0.12	0.15	0.11	0.10	0.11	0.22	0 of 37
PHENOL	2.09	2.06	2.17	2.26	5.40	2.06	2.28	2.06	2.36	2.96	2.15	2.09	2.46	11.60	1 of 37
PYRENE	1.05	1.03	1.08	1.13	1.13	1.03	1.14	1.03	1.18	1.48	1.07	1.05	1.12	2.24	0 of 37

Table A-8 Deer Island Effluent Characterization, Fiscal Year 1999, cont.

Volatile Organics (ug/L)													Average	Maximum	Times Detected	
	Jul	Aug	Sep	Oct	Nov	Dec	Jan	Feb	Mar	Apr	May	Jun				
1,1,1-TRICHLOROETHANE	0.50	0.50	0.50	0.50	0.50	0.50	0.50	0.50	0.50	0.50	0.50	0.50	0.50	0.50	0.50	0 of 34
1,1,2,2-TETRACHLOROETHANE	0.50	0.50	0.50	0.50	0.50	0.50	0.50	0.50	0.50	0.50	0.50	0.50	0.50	0.50	0.50	0 of 34
1,1,2-TRICHLOROETHANE	0.50	0.50	0.50	0.50	0.50	0.50	0.50	0.50	0.50	0.50	0.50	0.50	0.50	0.50	0.50	0 of 34
1,1-DICHLOROETHANE	0.50	0.50	0.50	0.50	0.50	0.50	0.50	0.50	0.50	0.50	0.50	0.50	0.50	0.50	0.50	0 of 34
1,1-DICHLOROETHENE	0.50	0.50	0.50	0.50	0.50	0.50	0.50	0.50	0.50	0.50	0.50	0.50	0.50	0.50	0.50	0 of 34
1,2-DICHLOROBENZENE	0.50	0.50	0.50	0.50	0.50	0.50	0.50	0.50	0.50	0.50	0.50	0.50	0.50	0.50	0.50	0 of 34
1,2-DICHLOROETHANE	0.50	0.50	0.50	0.50	0.50	0.50	0.50	0.50	0.50	0.50	0.50	0.50	0.50	0.50	0.50	0 of 34
1,2-DICHLOROPROPANE	0.50	0.50	0.50	0.50	0.50	0.50	0.50	0.50	0.50	0.50	0.50	0.50	0.50	0.50	0.50	0 of 34
1,3-DICHLOROBENZENE	0.50	0.50	0.50	0.50	0.50	0.50	0.50	0.50	0.50	0.50	0.50	0.50	0.50	0.50	0.50	0 of 34
1,4-DICHLOROBENZENE	0.50	0.50	0.50	0.50	0.50	0.50	0.50	0.50	0.50	0.50	0.50	0.50	0.50	0.50	0.50	0 of 34
2-BUTANONE	0.50	0.50	0.50	0.50	0.50	0.50	2.64	1.90	0.50	3.85	2.15	2.50	1.43	7.56	6 of 34	
2-CHLOROETHYL VINYL ETHER	0.50	0.50	0.50	0.50	0.50	0.50	0.50	0.50	0.50	0.50	0.50	0.50	0.50	0.50	0.50	0 of 34
2-HEXANONE	0.50	0.50	0.50	0.50	0.50	0.50	0.50	0.50	0.50	0.50	0.50	0.50	0.50	0.50	0.50	0 of 34
4-METHYL-2-PENTANONE	0.50	0.50	0.50	0.50	0.50	0.50	0.50	0.50	0.50	0.50	0.50	0.50	0.50	0.50	0.50	0 of 34
ACETONE	16.71	31.56	15.17	32.70	28.53	26.11	35.31	29.79	47.70	40.00	24.14	26.13	30.70	59.80	34 of 34	
ACROLEIN	0.50	0.50	0.50	0.50	0.50	0.50	0.50	0.50	0.50	0.50	0.50	0.50	0.50	0.50	0.50	0 of 34
ACRYLONITRILE	0.50	0.50	0.50	0.50	0.50	0.50	0.50	0.50	0.50	0.50	0.50	0.50	0.50	0.50	0.50	0 of 34
BENZENE	0.50	0.50	0.50	0.50	0.50	0.50	0.50	0.50	0.50	0.50	0.50	0.50	0.50	0.50	0.50	0 of 34
BROMODICHLOROMETHANE	0.50	0.50	0.50	0.50	0.50	0.50	0.50	0.50	0.50	0.50	0.50	0.50	0.50	0.50	0.50	0 of 34
BROMOFORM	0.50	0.50	0.50	0.50	0.50	0.50	0.50	0.50	0.50	0.50	0.50	0.50	0.50	0.50	0.50	0 of 34
BROMOMETHANE	0.50	0.50	0.50	0.50	0.50	0.50	0.50	0.50	0.50	0.50	0.50	0.50	0.50	0.50	0.50	0 of 34
CARBON DISULFIDE	0.50	0.50	0.50	0.50	5.13	0.50	0.50	0.50	0.50	0.50	0.50	0.50	0.86	8.79	2 of 34	
CARBON TETRACHLORIDE	0.50	0.50	0.50	0.50	0.50	0.50	0.50	0.50	0.50	0.50	0.50	0.50	0.50	0.50	0.50	0 of 34
CHLOROBENZENE	0.50	0.50	0.50	0.50	0.50	0.50	0.50	0.50	0.50	0.50	0.50	0.50	0.50	0.50	0.50	0 of 34
CHLOROETHANE	0.50	0.50	0.50	0.50	0.50	0.50	0.50	0.50	0.50	0.50	0.50	0.50	0.50	0.50	0.50	0 of 34
CHLOROFORM	7.02	6.37	4.42	7.37	7.01	7.43	7.48	6.01	6.76	9.67	10.19	8.35	7.38	11.60	33 of 34	
CHLOROMETHANE	0.50	0.50	0.50	0.50	0.50	0.50	0.50	0.50	0.50	0.50	0.50	0.50	0.50	0.50	0.50	0 of 34
CIS-1,2-DICHLOROETHENE	0.50	0.50	0.50	0.50	0.50	0.50	0.50	0.50	0.50	0.50	0.50	0.50	0.50	0.50	0.50	0 of 34
CIS-1,3-DICHLOROPROPENE	0.50	0.50	0.50	0.50	0.50	0.50	0.50	0.50	0.50	0.50	0.50	0.50	0.50	0.50	0.50	0 of 34
DIBROMOCHLOROMETHANE	0.50	0.50	0.50	0.50	0.50	0.50	0.50	0.50	0.50	0.50	0.50	0.50	0.50	0.50	0.50	0 of 34
ETHYLBENZENE	0.50	0.50	0.50	0.50	0.50	0.50	0.50	0.50	0.50	0.50	0.50	0.50	0.50	0.50	0.50	0 of 34
M,P-XYLENE	0.50	0.50	0.50	0.50	0.50	0.50	0.50	0.50	0.50	0.50	0.50	0.50	0.50	0.50	0.50	0 of 34
METHYLENE CHLORIDE	2.76	8.41	2.09	2.19	8.72	5.32	4.54	4.18	4.31	7.25	3.59	5.62	4.87	11.50	28 of 34	
O-XYLENE	0.50	0.50	0.50	0.50	0.50	0.50	0.50	0.50	0.50	0.50	0.50	0.50	0.50	0.50	0.50	0 of 34

Table A-8 Deer Island Effluent Characterization, Fiscal Year 1999, cont.

Volatile Organics (ug/L)															Times	
	Jul	Aug	Sep	Oct	Nov	Dec	Jan	Feb	Mar	Apr	May	Jun	Average	Maximum	Detected	
STYRENE	0.50	0.50	0.50	0.50	0.50	0.50	0.50	0.50	0.50	0.50	0.50	0.50	0.50	0.50	0.50	0 of 34
TETRACHLOROETHENE	2.79	3.50	1.75	1.58	5.72	4.32	2.90	2.12	4.99	3.77	1.94	4.68	3.32	9.64	24 of 34	
TOLUENE	0.50	0.50	0.50	3.02	0.50	0.50	0.50	0.50	0.50	0.50	0.50	0.50	0.74	5.63	1 of 34	
TRANS-1,2-DICHLOROETHENE	0.50	0.50	0.50	0.50	0.50	0.50	0.50	0.50	0.50	0.50	0.50	0.50	0.50	0.50	0 of 34	
TRANS-1,3-DICHLOROPROPENE	0.50	0.50	0.50	0.50	0.50	0.50	0.50	0.50	0.50	0.50	0.50	0.50	0.50	0.50	0 of 34	
TRICHLOROETHENE	0.50	0.50	0.50	0.50	0.50	0.50	0.50	0.50	0.50	0.50	0.50	0.50	0.50	0.50	0 of 34	
TRICHLOROFLUOROMETHANE	0.50	0.50	0.50	0.50	0.50	0.50	0.50	0.50	0.50	0.50	0.50	0.50	0.50	0.50	0 of 34	
VINYL ACETATE	0.50	0.50	0.50	0.50	0.50	0.50	0.50	0.50	0.50	0.50	0.50	0.50	0.50	0.50	0 of 34	
VINYL CHLORIDE	0.50	0.50	0.50	0.50	0.50	0.50	0.50	0.50	0.50	0.50	0.50	0.50	0.50	0.50	0 of 34	

Notes:

Results in ***bold italics*** indicate one or more detects in the month.

Yearly averages are calculated from individual results collected in the fiscal year.

Non-detected compounds are assumed to equal one half of the detection limit for metals and inorganics and one tenth of the reporting limit for organic compounds.

Table A-9 Deer Island Effluent Loadings, Fiscal Year 1999

Metals (lbs/day)															Times
	Jul	Aug	Sep	Oct	Nov	Dec	Jan	Feb	Mar	Apr	May	Jun	Average	Maximum	Detected
ANTIMONY	60.59	55.07	48.21	60.99	29.00	17.56	30.88	43.97	52.97	20.89	20.35	16.37	37.61	94.70	1 of 77
ARSENIC	1.82	2.20	0.96	2.25	1.41	1.96	2.98	1.39	2.89	1.95	2.22	1.11	1.89	8.36	24 of 78
BERYLLIUM	1.51	1.38	1.21	1.52	0.76	0.59	0.95	1.19	1.00	0.70	0.68	0.57	1.00	2.37	0 of 77
BORON	570.43	565.83	658.17	745.23	826.54	739.31	608.16	434.86	498.92	563.58	548.14	705.55	630.18	1316.38	46 of 77
CADMIUM	3.03	2.75	2.41	3.54	2.84	2.34	3.81	3.48	3.99	2.78	2.71	2.30	2.96	5.89	2 of 77
CHROMIUM	4.54	4.78	4.26	5.36	5.60	5.41	18.18	10.10	23.30	6.70	10.14	7.85	8.41	48.37	20 of 77
COPPER	45.01	35.53	30.19	59.25	33.46	42.84	93.20	78.72	81.25	61.71	60.72	30.81	52.67	151.53	66 of 77
HEXAVALENT CHROMIUM	16.50	13.66	12.95	16.41	13.71	12.44	15.62	20.17	19.91	15.87	14.32	12.67	15.51	24.21	0 of 34
IRON	1142.42	1244.37	1291.31	1795.35	844.42	1028.16	3099.29	2171.55	2432.08	1460.43	1714.29	770.85	1524.80	5567.25	78 of 78
LEAD	5.43	7.82	3.94	9.64	2.90	2.81	21.58	6.00	24.39	6.08	14.00	2.76	8.37	77.34	21 of 77
MERCURY	0.16	0.14	0.08	0.20	0.06	0.08	0.24	0.23	0.18	0.11	0.17	0.03	0.13	0.63	63 of 77
MOLYBDENUM	19.13	15.60	13.50	14.57	12.62	11.48	21.41	15.23	15.15	15.27	19.37	15.28	15.63	35.74	66 of 84
NICKEL	12.12	11.01	9.64	12.20	8.55	8.15	10.92	17.41	12.33	7.89	17.51	8.22	11.17	41.75	30 of 77
SELENIUM	1.96	1.40	2.51	3.03	1.09	1.05	1.71	1.57	1.80	1.25	1.22	1.42	1.64	9.60	2 of 77
SILVER	4.28	1.63	1.73	3.71	2.81	3.17	3.81	5.68	5.92	6.06	5.20	3.19	3.83	13.15	27 of 77
THALLIUM	1.73	1.98	1.21	1.96	1.21	1.17	1.90	1.74	2.00	1.39	1.36	1.15	1.55	6.27	3 of 77
ZINC	66.16	65.09	46.54	99.90	50.50	58.81	195.12	183.85	209.13	107.71	133.11	62.89	101.62	354.99	72 of 75
Cyanide and Phenols (lbs/day)															
	Jul	Aug	Sep	Oct	Nov	Dec	Jan	Feb	Mar	Apr	May	Jun	Average	Maximum	Times Detected
CYANIDE	15.00	12.42	11.77	14.92	12.46	11.31	14.20	18.34	18.10	14.43	13.02	11.52	14.10	22.01	0 of 34
TOTAL PHENOLS	22.28	18.13	2.48	3.09	2.51	18.29	21.39	21.98	15.35	2.93	2.49	11.80	12.17	80.05	9 of 37
Oil and Grease, Petroleum Hydrocarbons, and Surfactants (lbs/day)															
	Jul	Aug	Sep	Oct	Nov	Dec	Jan	Feb	Mar	Apr	May	Jun	Average	Maximum	Times Detected
PETROLEUM HYDROCARBON	1151	708	763	683	653	857	2028	1364	1644	1042	681	599	1027	3777	64 of 69
TOTAL PETROLEUM HYDROCARBON	4014	1202	1256	3705	5174	2021	7129	6341	2505	1710	271	528	2955	16719	38 of 69
FATS OIL AND GREASE	7455	4734	22409	13545	20408	23749	30003	33159	41728	43151	26582	8693	24051	92979	49 of 69
MBAS	3390	2090	2471	1910	2187	2073	7574	2517	3104	3102	3222	989	2908	18565	38 of 38

Table A-9 Deer Island Effluent Loadings, Fiscal Year 1999, cont.

Organochlorine Pesticides and PCBs (lbs/day)	Jul	Aug	Sep	Oct	Nov	Dec	Jan	Feb	Mar	Apr	May	Jun	Average	Maximum	Times Detected
4,4'-DDD	0.007	0.005	0.005	0.007	0.005	0.005	0.008	0.008	0.009	0.006	0.005	0.005	0.006	0.012	0 of 37
4,4'-DDE	0.007	0.005	0.005	0.007	0.005	0.005	0.008	0.008	0.009	0.006	0.005	0.005	0.006	0.012	0 of 37
4,4'-DDT	0.007	0.005	0.005	0.007	0.005	0.005	0.008	0.008	0.009	0.006	0.005	0.005	0.006	0.012	0 of 37
ALDRIN	0.007	0.005	0.005	0.007	0.005	0.005	0.008	0.008	0.009	0.006	0.005	0.005	0.006	0.012	0 of 37
ALPHA-BHC	0.007	0.019	0.005	0.007	0.005	0.005	0.008	0.008	0.009	0.006	0.005	0.005	0.007	0.048	1 of 37
ALPHA-CHLORDANE	0.007	0.005	0.005	0.007	0.005	0.005	0.008	0.008	0.009	0.006	0.005	0.005	0.006	0.012	0 of 37
AROCLOR-1016	0.169	0.132	0.131	0.167	0.135	0.125	0.198	0.200	0.219	0.157	0.132	0.123	0.158	0.304	0 of 37
AROCLOR-1221	0.337	0.264	0.262	0.334	0.271	0.251	0.394	0.400	0.438	0.314	0.264	0.246	0.315	0.605	0 of 37
AROCLOR-1232	0.169	0.132	0.131	0.167	0.135	0.125	0.198	0.200	0.219	0.157	0.132	0.123	0.158	0.304	0 of 37
AROCLOR-1242	0.169	0.132	0.131	0.167	0.135	0.125	0.198	0.200	0.219	0.157	0.132	0.123	0.158	0.304	0 of 37
AROCLOR-1248	0.169	0.132	0.131	0.167	0.135	0.125	0.198	0.200	0.219	0.157	0.132	0.123	0.158	0.304	0 of 37
AROCLOR-1254	0.169	0.132	0.131	0.167	0.135	0.125	0.198	0.200	0.219	0.157	0.132	0.123	0.158	0.304	0 of 37
AROCLOR-1260	0.169	0.132	0.131	0.167	0.135	0.125	0.198	0.200	0.219	0.157	0.132	0.123	0.158	0.304	0 of 37
BETA-BHC	0.007	0.015	0.005	0.007	0.005	0.005	0.008	0.008	0.009	0.006	0.005	0.005	0.007	0.034	2 of 37
CHLORDANE (TECHNICAL)	0.169	0.132	0.131	0.167	0.135	0.125	0.198	0.200	0.219	0.157	0.132	0.123	0.158	0.304	0 of 37
DELTA-BHC	0.007	0.005	0.005	0.007	0.005	0.005	0.008	0.008	0.009	0.006	0.005	0.005	0.006	0.012	0 of 37
DIELDRIN	0.007	0.005	0.005	0.007	0.005	0.005	0.008	0.008	0.009	0.006	0.005	0.005	0.006	0.012	0 of 37
ENDOSULFAN I	0.007	0.005	0.005	0.007	0.005	0.005	0.008	0.008	0.009	0.006	0.005	0.005	0.006	0.012	0 of 37
ENDOSULFAN II	0.007	0.005	0.005	0.007	0.005	0.005	0.008	0.008	0.009	0.006	0.005	0.005	0.006	0.012	0 of 37
ENDOSULFAN SULFATE	0.007	0.005	0.005	0.007	0.005	0.005	0.008	0.008	0.009	0.006	0.005	0.005	0.006	0.012	0 of 37
ENDRIN	0.007	0.005	0.005	0.007	0.005	0.005	0.008	0.008	0.009	0.006	0.005	0.005	0.006	0.012	0 of 37
ENDRIN ALDEHYDE	0.007	0.005	0.005	0.007	0.005	0.005	0.008	0.008	0.009	0.006	0.005	0.005	0.006	0.012	0 of 37
ENDRIN KETONE	0.007	0.005	0.005	0.007	0.005	0.005	0.008	0.008	0.009	0.006	0.005	0.005	0.006	0.012	0 of 37
GAMMA-BHC (LINDANE)	0.007	0.011	0.005	0.007	0.005	0.005	0.008	0.008	0.009	0.006	0.005	0.005	0.007	0.021	1 of 37
GAMMA-CHLORDANE	0.007	0.005	0.005	0.007	0.005	0.005	0.008	0.008	0.009	0.006	0.005	0.005	0.006	0.012	0 of 37
HEPTACHLOR	0.007	0.005	0.005	0.007	0.005	0.005	0.008	0.008	0.009	0.006	0.005	0.005	0.006	0.012	0 of 37
HEPTACHLOR EPOXIDE	0.007	0.005	0.005	0.007	0.005	0.005	0.008	0.008	0.009	0.006	0.005	0.005	0.006	0.012	0 of 37
METHOXYCHLOR	0.094	0.053	0.052	0.067	0.054	0.050	0.079	0.080	0.087	0.063	0.053	0.049	0.066	0.174	0 of 37
TOXAPHENE	0.169	0.132	0.131	0.167	0.135	0.125	0.198	0.200	0.219	0.157	0.132	0.123	0.158	0.304	0 of 37

Table A-9 Deer Island Effluent Loadings, Fiscal Year 1999, cont.

Semivolatile Organics (lbs/day)	Jul	Aug	Sep	Oct	Nov	Dec	Jan	Feb	Mar	Apr	May	Jun	Average	Maximum	Times Detected
1,2,4-TRICHLOROBENZENE	3.30	2.54	2.68	3.50	2.83	2.56	3.80	3.85	4.41	4.33	2.67	2.39	3.24	6.70	0 of 37
1,2-DICHLOROBENZENE	3.30	2.54	2.68	3.50	2.83	2.56	3.80	3.85	4.41	4.33	2.67	2.39	3.24	6.70	0 of 37
1,2-DIPHENYLHYDRAZINE (AS AZOB)	3.30	2.54	2.68	3.50	2.83	2.56	3.80	3.85	4.41	4.33	2.67	2.39	3.24	6.70	0 of 37
1,3-DICHLOROBENZENE	3.30	2.54	2.68	3.50	2.83	2.56	3.80	3.85	4.41	4.33	2.67	2.39	3.24	6.70	0 of 37
1,4-DICHLOROBENZENE	3.30	2.54	2.68	3.50	2.83	2.56	3.80	3.85	4.41	4.33	2.67	2.39	3.24	6.70	0 of 37
2,2'-OXYBIS(1-CHLOROPROPANE)	3.30	2.54	2.68	3.50	2.83	2.56	3.80	3.85	4.41	4.33	2.67	2.39	3.24	6.70	0 of 37
2,4,5-TRICHLOROPHENOL	3.30	2.54	2.68	3.50	2.83	2.56	3.80	3.85	4.41	4.33	2.67	2.39	3.24	6.70	0 of 37
2,4,6-TRICHLOROPHENOL	3.30	2.54	2.68	3.50	2.83	2.56	3.80	3.85	4.41	4.33	2.67	2.39	3.24	6.70	0 of 37
2,4-DICHLOROPHENOL	3.30	2.54	2.68	3.50	2.83	2.56	3.80	3.85	4.41	4.33	2.67	2.39	3.24	6.70	0 of 37
2,4-DIMETHYLPHENOL	3.30	2.54	2.68	3.50	2.83	2.56	3.80	3.85	4.41	4.33	2.67	2.39	3.24	6.70	0 of 37
2,4-DINITROPHENOL	6.60	5.08	5.37	6.99	5.67	5.13	7.60	7.69	8.83	8.66	5.33	4.77	6.48	13.40	0 of 37
2,4-DINITROTOLUENE	3.30	2.54	2.68	3.50	2.83	2.56	3.80	3.85	4.41	4.33	2.67	2.39	3.24	6.70	0 of 37
2,6-DINITROTOLUENE	3.30	2.54	2.68	3.50	2.83	2.56	3.80	3.85	22.58	4.33	2.67	2.39	4.71	58.54	1 of 37
2-CHLORONAPHTHALENE	3.30	2.54	2.68	3.50	2.83	2.56	3.80	3.85	4.41	4.33	2.67	2.39	3.24	6.70	0 of 37
2-CHLOROPHENOL	3.30	2.54	2.68	3.50	2.83	2.56	3.80	3.85	4.41	4.33	2.67	2.39	3.24	6.70	0 of 37
2-METHYL-4,6-DINITROPHENOL	33.02	25.42	26.84	34.97	28.33	25.63	38.01	38.47	44.15	43.29	26.67	23.87	32.41	67.01	0 of 37
2-METHYLNAPHTHALENE	3.30	2.54	2.68	3.50	2.83	2.56	3.80	3.85	4.41	4.33	2.67	2.39	3.24	6.70	0 of 37
2-METHYLPHENOL	3.30	2.54	2.68	3.50	2.83	2.56	3.80	3.85	4.41	4.33	2.67	2.39	3.24	6.70	0 of 37
2-NITROANILINE	3.30	2.54	2.68	3.50	2.83	2.56	3.80	3.85	4.41	4.33	2.67	2.39	3.24	6.70	0 of 37
2-NITROPHENOL	3.30	2.54	2.68	3.50	2.83	2.56	3.80	3.85	4.41	4.33	2.67	2.39	3.24	6.70	0 of 37
3,3'-DICHLOROBENZIDINE	6.60	5.08	5.37	6.99	5.67	5.13	7.60	7.69	8.83	8.66	5.33	4.77	6.48	13.40	0 of 37
3-NITROANILINE	3.30	2.54	2.68	3.50	2.83	2.56	3.80	3.85	4.41	4.33	2.67	2.39	3.24	6.70	0 of 37
4-BROMOPHENYL PHENYL ETHER	3.30	2.54	2.68	3.50	2.83	2.56	3.80	3.85	4.41	4.33	2.67	2.39	3.24	6.70	0 of 37
4-CHLORO-3-METHYLPHENOL	3.30	2.54	2.68	3.50	2.83	2.56	3.80	3.85	4.41	4.33	2.67	2.39	3.24	6.70	0 of 37
4-CHLOROANILINE	3.30	2.54	2.68	3.50	2.83	2.56	3.80	3.85	4.41	4.33	2.67	2.39	3.24	6.70	0 of 37
4-CHLOROPHENYL PHENYL ETHER	3.30	2.54	2.68	3.50	2.83	2.56	3.80	3.85	4.41	4.33	2.67	2.39	3.24	6.70	0 of 37
4-METHYLPHENOL (INCLUDES 3-MET)	3.30	2.54	2.68	3.50	6.38	2.56	13.64	3.85	4.41	4.33	2.67	2.39	4.33	35.06	2 of 37
4-NITROANILINE	3.30	2.54	2.68	3.50	2.83	2.56	3.80	3.85	4.41	4.33	2.67	2.39	3.24	6.70	0 of 37
4-NITROPHENOL	6.60	5.08	5.37	6.99	5.67	5.13	7.60	7.69	8.83	8.66	5.33	4.77	6.48	13.40	0 of 37
ACENAPHTHENE	3.30	2.54	2.68	3.50	2.83	2.56	3.80	3.85	4.41	4.33	2.67	2.39	3.24	6.70	0 of 37
ACENAPHTHYLENE	3.30	2.54	2.68	3.50	2.83	2.56	3.80	3.85	4.41	4.33	2.67	2.39	3.24	6.70	0 of 37
ANILINE	3.30	2.54	2.68	3.50	2.83	2.56	3.80	3.85	4.41	4.33	2.67	2.39	3.24	6.70	0 of 37
ANTHRACENE	3.30	2.54	2.68	3.50	2.83	2.56	3.80	3.85	4.41	4.33	2.67	2.39	3.24	6.70	0 of 37
BENZIDINE	16.51	12.71	13.42	17.48	14.17	12.81	19.01	19.23	22.07	21.65	13.34	11.94	16.20	33.51	0 of 37
BENZO(A)ANTHRACENE	3.30	2.54	2.68	3.50	2.83	2.56	3.80	3.85	4.41	4.33	2.67	2.39	3.24	6.70	0 of 37

Table A-9 Deer Island Effluent Loadings, Fiscal Year 1999, cont.

Semivolatile Organics (lbs/day)	Jul	Aug	Sep	Oct	Nov	Dec	Jan	Feb	Mar	Apr	May	Jun	Average	Maximum	Times Detected
BENZO(A)PYRENE	3.30	2.54	2.68	3.50	2.83	2.56	3.80	3.85	4.41	4.33	2.67	2.39	3.24	6.70	0 of 37
BENZO(B)FLUORANTHENE	3.30	2.54	2.68	3.50	2.83	2.56	3.80	3.85	4.41	4.33	2.67	2.39	3.24	6.70	0 of 37
BENZO(GHI)PERYLENE	3.30	2.54	2.68	3.50	2.83	2.56	3.80	3.85	4.41	4.33	2.67	2.39	3.24	6.70	0 of 37
BENZO(K)FLUORANTHENE	3.30	2.54	2.68	3.50	2.83	2.56	3.80	3.85	4.41	4.33	2.67	2.39	3.24	6.70	0 of 37
BENZOIC ACID	6.60	5.08	5.37	6.99	11.32	5.13	7.60	7.69	8.83	8.66	5.33	4.77	6.94	22.19	1 of 37
BENZYL ALCOHOL	3.30	2.54	2.68	3.50	9.71	2.56	3.80	3.85	72.95	4.33	2.67	2.39	9.35	128.48	1 of 37
BIS(2-CHLOROETHOXY)METHANE	3.30	2.54	2.68	3.50	2.83	2.56	3.80	3.85	4.41	4.33	2.67	2.39	3.24	6.70	0 of 37
BIS(2-CHLOROETHYL)ETHER	3.30	2.54	2.68	3.50	2.83	2.56	3.80	3.85	4.41	4.33	2.67	2.39	3.24	6.70	0 of 37
BIS(2-ETHYLHEXYL)PHTHALATE	3.30	2.54	2.68	11.67	20.73	2.56	12.11	3.85	4.41	4.33	2.67	2.39	6.03	56.31	3 of 37
BUTYL BENZYL PHTHALATE	3.30	2.54	2.68	3.50	2.83	2.56	3.80	3.85	4.41	4.33	2.67	2.39	3.24	6.70	0 of 37
CHRYSENE	3.30	2.54	2.68	3.50	2.83	2.56	3.80	3.85	4.41	4.33	2.67	2.39	3.24	6.70	0 of 37
DIBENZO(A,H)ANTHRACENE	3.30	2.54	2.68	3.50	2.83	2.56	3.80	3.85	4.41	4.33	2.67	2.39	3.24	6.70	0 of 37
DIBENZOFURAN	3.30	2.54	2.68	3.50	2.83	2.56	3.80	3.85	4.41	4.33	2.67	2.39	3.24	6.70	0 of 37
DIETHYL PHTHALATE	3.30	2.54	2.68	3.50	2.83	2.56	3.80	12.28	4.41	4.33	2.67	2.39	3.92	29.12	1 of 37
DIMETHYL PHTHALATE	3.30	2.54	2.68	3.50	2.83	2.56	3.80	3.85	4.41	4.33	2.67	2.39	3.24	6.70	0 of 37
DI-N-BUTYLPHTHALATE	3.30	2.54	2.68	3.50	2.83	2.56	3.80	3.85	4.41	4.33	2.67	2.39	3.24	6.70	0 of 37
DI-N-OCTYLPHTHALATE	3.30	2.54	2.68	3.50	2.83	2.56	3.80	3.85	4.41	4.33	2.67	2.39	3.24	6.70	0 of 37
FLUORANTHENE	3.30	2.54	2.68	3.50	2.83	2.56	3.80	3.85	4.41	4.33	2.67	2.39	3.24	6.70	0 of 37
FLUORENE	3.30	2.54	2.68	3.50	2.83	2.56	3.80	3.85	4.41	4.33	2.67	2.39	3.24	6.70	0 of 37
HEXACHLOROBENZENE	3.30	2.54	2.68	3.50	2.83	2.56	3.80	3.85	4.41	4.33	2.67	2.39	3.24	6.70	0 of 37
HEXACHLOROBUTADIENE	3.30	2.54	2.68	3.50	2.83	2.56	3.80	3.85	4.41	4.33	2.67	2.39	3.24	6.70	0 of 37
HEXACHLOROCYCLOPENTADIENE	16.51	12.71	13.42	17.48	14.17	12.81	19.01	19.23	22.07	21.65	13.34	11.94	16.20	33.51	0 of 37
HEXACHLOROETHANE	3.30	2.54	2.68	3.50	2.83	2.56	3.80	3.85	4.41	4.33	2.67	2.39	3.24	6.70	0 of 37
INDENO(1,2,3-CD)PYRENE	3.30	2.54	2.68	3.50	2.83	2.56	3.80	3.85	4.41	4.33	2.67	2.39	3.24	6.70	0 of 37
ISOPHORONE	3.30	2.54	2.68	3.50	2.83	2.56	3.80	3.85	4.41	4.33	2.67	2.39	3.24	6.70	0 of 37
NAPHTHALENE	3.30	2.54	2.68	3.50	2.83	2.56	3.80	3.85	4.41	4.33	2.67	2.39	3.24	6.70	0 of 37
NITROBENZENE	3.30	2.54	2.68	3.50	2.83	2.56	3.80	3.85	4.41	4.33	2.67	2.39	3.24	6.70	0 of 37
N-NITROSODIMETHYLAMINE	3.30	2.54	2.68	3.50	2.83	2.56	3.80	3.85	4.41	4.33	2.67	2.39	3.24	6.70	0 of 37
N-NITROSDI-N-PROPYLAMINE	3.30	2.54	2.68	3.50	2.83	2.56	3.80	3.85	4.41	4.33	2.67	2.39	3.24	6.70	0 of 37
N-NITROSODIPHENYLAMINE	3.30	2.54	2.68	3.50	2.83	2.56	3.80	3.85	4.41	4.33	2.67	2.39	3.24	6.70	0 of 37
PENTACHLOROPHENOL	16.51	12.71	13.42	15.61	8.50	7.69	11.40	11.54	13.24	12.99	8.00	7.16	11.70	26.04	0 of 37
PHENANTHRENE	0.33	0.25	0.27	0.35	0.28	0.26	0.38	0.38	0.44	0.43	0.27	0.24	0.32	0.67	0 of 37
PHENOL	6.60	5.08	5.37	6.99	13.52	5.13	7.60	7.69	8.83	8.66	5.33	4.77	7.12	28.79	1 of 37
PYRENE	3.30	2.54	2.68	3.50	2.83	2.56	3.80	3.85	4.41	4.33	2.67	2.39	3.24	6.70	0 of 37

Table A-9 Deer Island Effluent Loadings, Fiscal Year 1999, cont.

Volatile Organics (lbs/day)															Times Detected
	Jul	Aug	Sep	Oct	Nov	Dec	Jan	Feb	Mar	Apr	May	Jun	Average	Maximum	
1,1,1-TRICHLOROETHANE	1.50	1.24	1.18	1.49	1.25	1.13	1.42	1.83	1.81	1.44	1.30	1.15	1.41	2.20	0 of 34
1,1,2,2-TETRACHLOROETHANE	1.50	1.24	1.18	1.49	1.25	1.13	1.42	1.83	1.81	1.44	1.30	1.15	1.41	2.20	0 of 34
1,1,2-TRICHLOROETHANE	1.50	1.24	1.18	1.49	1.25	1.13	1.42	1.83	1.81	1.44	1.30	1.15	1.41	2.20	0 of 34
1,1-DICHLOROETHANE	1.50	1.24	1.18	1.49	1.25	1.13	1.42	1.83	1.81	1.44	1.30	1.15	1.41	2.20	0 of 34
1,1-DICHLOROETHENE	1.50	1.24	1.18	1.49	1.25	1.13	1.42	1.83	1.81	1.44	1.30	1.15	1.41	2.20	0 of 34
1,2-DICHLOROBENZENE	1.50	1.24	1.18	1.49	1.25	1.13	1.42	1.83	1.81	1.44	1.30	1.15	1.41	2.20	0 of 34
1,2-DICHLOROETHANE	1.50	1.24	1.18	1.49	1.25	1.13	1.42	1.83	1.81	1.44	1.30	1.15	1.41	2.20	0 of 34
1,2-DICHLOROPROPANE	1.50	1.24	1.18	1.49	1.25	1.13	1.42	1.83	1.81	1.44	1.30	1.15	1.41	2.20	0 of 34
1,3-DICHLOROBENZENE	1.50	1.24	1.18	1.49	1.25	1.13	1.42	1.83	1.81	1.44	1.30	1.15	1.41	2.20	0 of 34
1,4-DICHLOROBENZENE	1.50	1.24	1.18	1.49	1.25	1.13	1.42	1.83	1.81	1.44	1.30	1.15	1.41	2.20	0 of 34
2-BUTANONE	1.50	1.24	1.18	1.49	1.25	1.13	7.50	6.96	1.81	11.11	5.60	5.76	4.04	22.21	6 of 34
2-CHLOROETHYL VINYL ETHER	1.50	1.24	1.18	1.49	1.25	1.13	1.42	1.83	1.81	1.44	1.30	1.15	1.41	2.20	0 of 34
2-HEXANONE	1.50	1.24	1.18	1.49	1.25	1.13	1.42	1.83	1.81	1.44	1.30	1.15	1.41	2.20	0 of 34
4-METHYL-2-PENTANONE	1.50	1.24	1.18	1.49	1.25	1.13	1.42	1.83	1.81	1.44	1.30	1.15	1.41	2.20	0 of 34
ACETONE	50.11	78.36	35.72	97.57	71.12	59.04	100.25	109.26	172.67	115.46	62.83	60.20	86.56	221.42	34 of 34
ACROLEIN	1.50	1.24	1.18	1.49	1.25	1.13	1.42	1.83	1.81	1.44	1.30	1.15	1.41	2.20	0 of 34
ACRYLONITRILE	1.50	1.24	1.18	1.49	1.25	1.13	1.42	1.83	1.81	1.44	1.30	1.15	1.41	2.20	0 of 34
BENZENE	1.50	1.24	1.18	1.49	1.25	1.13	1.42	1.83	1.81	1.44	1.30	1.15	1.41	2.20	0 of 34
BROMODICHLOROMETHANE	1.50	1.24	1.18	1.49	1.25	1.13	1.42	1.83	1.81	1.44	1.30	1.15	1.41	2.20	0 of 34
BROMOFORM	1.50	1.24	1.18	1.49	1.25	1.13	1.42	1.83	1.81	1.44	1.30	1.15	1.41	2.20	0 of 34
BROMOMETHANE	1.50	1.24	1.18	1.49	1.25	1.13	1.42	1.83	1.81	1.44	1.30	1.15	1.41	2.20	0 of 34
CARBON DISULFIDE	1.50	1.24	1.18	1.49	12.80	1.13	1.42	1.83	1.81	1.44	1.30	1.15	2.43	21.61	2 of 34
CARBON TETRACHLORIDE	1.50	1.24	1.18	1.49	1.25	1.13	1.42	1.83	1.81	1.44	1.30	1.15	1.41	2.20	0 of 34
CHLOROBENZENE	1.50	1.24	1.18	1.49	1.25	1.13	1.42	1.83	1.81	1.44	1.30	1.15	1.41	2.20	0 of 34
CHLOROETHANE	1.50	1.24	1.18	1.49	1.25	1.13	1.42	1.83	1.81	1.44	1.30	1.15	1.41	2.20	0 of 34
CHLOROFORM	21.06	15.81	10.42	21.98	17.46	16.80	21.24	22.04	24.47	27.92	26.52	19.25	20.81	32.60	33 of 34
CHLOROMETHANE	1.50	1.24	1.18	1.49	1.25	1.13	1.42	1.83	1.81	1.44	1.30	1.15	1.41	2.20	0 of 34
CIS-1,2-DICHLOROETHENE	1.50	1.24	1.18	1.49	1.25	1.13	1.42	1.83	1.81	1.44	1.30	1.15	1.41	2.20	0 of 34
CIS-1,3-DICHLOROPROPENE	1.50	1.24	1.18	1.49	1.25	1.13	1.42	1.83	1.81	1.44	1.30	1.15	1.41	2.20	0 of 34
DIBROMOCHLOROMETHANE	1.50	1.24	1.18	1.49	1.25	1.13	1.42	1.83	1.81	1.44	1.30	1.15	1.41	2.20	0 of 34
ETHYLBENZENE	1.50	1.24	1.18	1.49	1.25	1.13	1.42	1.83	1.81	1.44	1.30	1.15	1.41	2.20	0 of 34
M,P-XYLENE	1.50	1.24	1.18	1.49	1.25	1.13	1.42	1.83	1.81	1.44	1.30	1.15	1.41	2.20	0 of 34
METHYLENE CHLORIDE	8.27	20.88	4.92	6.54	21.73	12.03	12.89	15.33	15.61	20.92	9.35	12.96	13.74	29.62	28 of 34
O-XYLENE	1.50	1.24	1.18	1.49	1.25	1.13	1.42	1.83	1.81	1.44	1.30	1.15	1.41	2.20	0 of 34
STYRENE	1.50	1.24	1.18	1.49	1.25	1.13	1.42	1.83	1.81	1.44	1.30	1.15	1.41	2.20	0 of 34
TETRACHLOROETHENE	8.38	8.68	4.12	4.72	14.27	9.77	8.22	7.78	18.08	10.88	5.04	10.79	9.36	34.96	24 of 34
TOLUENE	1.50	1.24	1.18	9.02	1.25	1.13	1.42	1.83	1.81	1.44	1.30	1.15	2.07	24.78	1 of 34
TRANS-1,2-DICHLOROETHENE	1.50	1.24	1.18	1.49	1.25	1.13	1.42	1.83	1.81	1.44	1.30	1.15	1.41	2.20	0 of 34

Table A-9 Deer Island Effluent Loadings, Fiscal Year 1999, cont.

Volatile Organics (lbs/day)															Times
	Jul	Aug	Sep	Oct	Nov	Dec	Jan	Feb	Mar	Apr	May	Jun	Average	Maximum	Detected
TRANS-1,3-DICHLOROPROPENE	1.50	1.24	1.18	1.49	1.25	1.13	1.42	1.83	1.81	1.44	1.30	1.15	1.41	2.20	0 of 34
TRICHLOROETHENE	1.50	1.24	1.18	1.49	1.25	1.13	1.42	1.83	1.81	1.44	1.30	1.15	1.41	2.20	0 of 34
TRICHLOROFLUOROMETHANE	1.50	1.24	1.18	1.49	1.25	1.13	1.42	1.83	1.81	1.44	1.30	1.15	1.41	2.20	0 of 34
VINYL ACETATE	1.50	1.24	1.18	1.49	1.25	1.13	1.42	1.83	1.81	1.44	1.30	1.15	1.41	2.20	0 of 34
VINYL CHLORIDE	1.50	1.24	1.18	1.49	1.25	1.13	1.42	1.83	1.81	1.44	1.30	1.15	1.41	2.20	0 of 34

Notes:

Results in ***bold italics*** indicate one or more detects in the month.

Yearly averages are calculated from individual results collected in the fiscal year.

Non-detected compounds are assumed to equal one half of the detection limit for metals and inorganics and one tenth of the reporting limit for organic compounds.

Table A-10 Deer Island Influent Characterization (DEC), Fiscal Year 1999

North & South Systems

Metals (ug/L)													Average	Maximum	Times Detected
	Jul	Aug	Sep	Oct	Nov	Dec	Jan	Feb	Mar	Apr	May	Jun			
CADMIUM	0.41	0.60	0.57	0.49	0.42	0.40	0.36	0.38	0.37	0.35	0.57	0.35	0.44	0.81	91 of 91
CHROMIUM	5.40	4.06	8.73	4.83	4.25	4.84	2.88	4.20	5.35	3.41	6.79	3.78	5.15	13.76	91 of 91
COPPER	85.33	87.18	99.98	82.96	68.17	80.81	46.18	54.09	53.35	57.93	84.54	71.14	72.43	135.91	91 of 91
LEAD	14.98	16.69	37.31	16.81	10.27	9.03	6.74	13.54	9.76	6.32	52.16	9.19	18.71	88.43	91 of 91
MERCURY	0.24	0.32	0.48	0.31	0.29	0.63	0.13	0.18	0.20	0.27	0.83	0.29	0.36	1.34	90 of 91
MOLYBDENUM	9.19	9.14	6.23	10.49	5.30	2.74	3.28	3.84	3.26	5.17	7.68	7.75	5.95	12.68	85 of 91
NICKEL	5.41	2.97	8.88	4.31	4.22	3.71	6.78	4.11	3.78	3.43	5.23	3.91	4.67	14.54	90 of 91
SILVER	3.01	4.28	5.14	6.62	2.87	2.81	3.06	2.40	1.97	3.23	3.41	2.94	3.30	8.17	91 of 91
ZINC	108.78	110.22	142.97	103.97	93.27	110.02	66.82	97.35	92.79	121.12	167.64	110.08	112.92	210.37	91 of 91

North System

Metals (ug/L)													Average	Maximum	Times Detected
	Jul	Aug	Sep	Oct	Nov	Dec	Jan	Feb	Mar	Apr	May	Jun			
CADMIUM	0.41	0.57	0.51	0.48	0.44	0.41	0.40	0.43	0.35	0.46	0.52	0.33	0.44	0.88	38 of 38
CHROMIUM	5.40	3.48	7.08	4.16	4.69	5.05	3.52	5.11	5.77	4.20	6.54	3.90	5.13	12.40	38 of 38
COPPER	80.57	66.83	83.87	73.20	67.97	76.18	50.30	59.86	54.69	67.23	80.28	67.76	68.66	137.00	38 of 38
LEAD	15.20	16.07	33.16	18.00	9.38	6.22	7.11	17.33	9.72	17.09	54.67	9.32	19.47	114.00	38 of 38
MERCURY	0.22	0.28	0.26	0.30	0.27	0.61	0.13	0.16	0.18	0.27	0.87	0.26	0.31	1.67	37 of 38
MOLYBDENUM	9.16	10.86	6.15	14.11	5.96	2.75	5.13	5.56	4.51	8.72	10.33	10.05	7.61	17.00	38 of 38
NICKEL	5.98	2.80	6.98	3.96	5.10	3.98	4.57	4.37	4.49	4.67	5.28	3.61	4.73	16.20	38 of 38
SILVER	2.88	3.33	4.29	6.50	3.15	2.71	3.80	2.65	2.07	4.11	4.14	3.68	3.42	9.64	38 of 38
ZINC	103.91	90.82	125.54	92.03	93.71	103.59	66.50	109.62	91.31	123.95	161.18	101.17	109.48	230.00	38 of 38

Organochlorine Pesticides and PCBs (ug/L)

													Average	Maximum	Times Detected
	Jul	Aug	Sep	Oct	Nov	Dec	Jan	Feb	Mar	Apr	May	Jun			
4,4'-DDD	~	~	~	~	~	~	~	~	~	0.0075	~	~	0.0075	0.0075	1 of 1
4,4'-DDE	~	~	~	~	~	~	~	~	~	0.0027	~	~	0.0027	0.0027	1 of 1
4,4'-DDT	~	~	~	~	~	~	~	~	~	0.0036	~	~	0.0036	0.0036	1 of 1
ALDRIN	~	~	~	~	~	~	~	~	~	0.0005	~	~	0.0005	0.0005	0 of 1
ALPHA-CHLORDANE	~	~	~	~	~	~	~	~	~	0.0005	~	~	0.0005	0.0005	0 of 1
DIELDRIN	~	~	~	~	~	~	~	~	~	0.0005	~	~	0.0005	0.0005	0 of 1
ENDRIN	~	~	~	~	~	~	~	~	~	0.0005	~	~	0.0005	0.0005	0 of 1
GAMMA-BHC (LINDANE)	~	~	~	~	~	~	~	~	~	0.0005	~	~	0.0005	0.0005	0 of 1
GAMMA-CHLORDANE	~	~	~	~	~	~	~	~	~	0.0005	~	~	0.0005	0.0005	0 of 1
HEPTACHLOR	~	~	~	~	~	~	~	~	~	0.0005	~	~	0.0005	0.0005	0 of 1
HEPTACHLOR EPOXIDE	~	~	~	~	~	~	~	~	~	0.0005	~	~	0.0005	0.0005	0 of 1

Table A-10 Deer Island Influent Characterization (DEC), Fiscal Year 1999, cont.

South System

Metals (ug/L)	Jul	Aug	Sep	Oct	Nov	Dec	Jan	Feb	Mar	Apr	May	Jun	Average	Maximum	Times Detected
CADMIUM	<i>0.42</i>	<i>0.62</i>	<i>0.47</i>	<i>0.48</i>	<i>0.37</i>	<i>0.38</i>	<i>0.30</i>	<i>0.28</i>	<i>0.35</i>	<i>0.20</i>	<i>0.52</i>	<i>0.41</i>	0.39	0.65	34 of 34
CHROMIUM	<i>5.41</i>	<i>6.09</i>	<i>7.84</i>	<i>5.40</i>	<i>3.25</i>	<i>4.45</i>	<i>1.95</i>	<i>2.60</i>	<i>4.60</i>	<i>2.05</i>	<i>4.93</i>	<i>4.26</i>	4.35	17.40	34 of 34
COPPER	<i>100.77</i>	<i>127.78</i>	<i>103.30</i>	<i>98.75</i>	<i>71.07</i>	<i>89.93</i>	<i>46.08</i>	<i>43.89</i>	<i>44.69</i>	<i>51.90</i>	<i>93.73</i>	<i>84.89</i>	72.82	144.00	34 of 34
LEAD	<i>14.27</i>	<i>17.71</i>	<i>14.33</i>	<i>11.18</i>	<i>10.79</i>	<i>14.56</i>	<i>5.97</i>	<i>6.85</i>	<i>7.15</i>	<i>4.62</i>	<i>16.47</i>	<i>9.19</i>	10.40	23.00	34 of 34
MERCURY	<i>0.32</i>	<i>0.44</i>	<i>0.59</i>	<i>0.34</i>	<i>0.31</i>	<i>0.66</i>	<i>0.13</i>	<i>0.22</i>	<i>0.17</i>	<i>0.26</i>	<i>0.34</i>	<i>0.30</i>	0.31	1.48	34 of 34
MOLYBDENUM	<i>9.29</i>	<i>2.69</i>	<i>3.80</i>	<i>4.60</i>	<i>4.13</i>	<i>2.70</i>	<i>0.77</i>	<i>0.81</i>	<i>1.62</i>	<i>2.00</i>	<i>2.23</i>	<i>3.45</i>	2.67	14.20	28 of 34
NICKEL	<i>3.58</i>	<i>2.60</i>	<i>8.00</i>	<i>4.68</i>	<i>3.31</i>	<i>3.18</i>	<i>6.85</i>	<i>3.64</i>	<i>2.99</i>	<i>3.14</i>	<i>3.83</i>	<i>5.75</i>	4.26	15.40	33 of 34
SILVER	<i>3.42</i>	<i>6.15</i>	<i>5.21</i>	<i>5.68</i>	<i>2.93</i>	<i>3.00</i>	<i>1.91</i>	<i>1.97</i>	<i>1.83</i>	<i>2.80</i>	<i>3.41</i>	<i>2.71</i>	3.10	8.96	34 of 34
ZINC	<i>124.58</i>	<i>146.05</i>	<i>120.66</i>	<i>121.58</i>	<i>92.88</i>	<i>122.72</i>	<i>69.89</i>	<i>75.70</i>	<i>87.48</i>	<i>85.80</i>	<i>161.30</i>	<i>138.08</i>	106.87	176.00	34 of 34

Notes:

DEC is Detailed Effluent Characterization project in LIMS, which includes new testing methods that are not EPA approved.

~ No samples taken

Results in *bold italics* indicate one or more detects in the month.

Yearly averages are calculated from individual results collected in the fiscal year.

Non-detected compounds are assumed to equal one half of the detection limit for metals and inorganics and one tenth of the reporting limit for organic compounds.

Table A-12 Deer Island Effluent Characterization (DEC), Fiscal Year 1999

Metals (ug/L)														Times	
	Jul	Aug	Sep	Oct	Nov	Dec	Jan	Feb	Mar	Apr	May	Jun	Average	Maximum	Detected
CADMIUM	<i>0.07</i>	<i>0.09</i>	<i>0.10</i>	<i>0.11</i>	<i>0.10</i>	<i>0.08</i>	<i>0.15</i>	<i>0.16</i>	<i>0.15</i>	<i>0.16</i>	<i>0.19</i>	<i>0.06</i>	0.13	0.31	38 of 38
CHROMIUM	<i>1.16</i>	<i>0.80</i>	<i>1.25</i>	<i>0.89</i>	<i>0.87</i>	<i>0.76</i>	<i>1.34</i>	<i>1.55</i>	<i>2.27</i>	<i>1.44</i>	<i>2.47</i>	<i>1.20</i>	1.50	4.67	36 of 38
COPPER	<i>15.81</i>	<i>13.37</i>	<i>10.87</i>	<i>9.40</i>	<i>14.63</i>	<i>15.29</i>	<i>19.99</i>	<i>26.22</i>	<i>17.16</i>	<i>24.16</i>	<i>22.93</i>	<i>17.52</i>	18.59	44.90	33 of 38
LEAD	1.20	1.20	1.70	1.20	1.20	1.20	2.73	3.45	2.72	2.74	9.30	1.20	2.86	21.40	13 of 38
MERCURY	<i>0.04</i>	<i>0.04</i>	<i>0.03</i>	<i>0.02</i>	<i>0.03</i>	<i>0.02</i>	<i>0.06</i>	<i>0.05</i>	<i>0.08</i>	<i>0.07</i>	<i>0.12</i>	<i>0.02</i>	0.05	0.24	30 of 38
MOLYBDENUM	<i>7.26</i>	<i>8.07</i>	<i>7.87</i>	<i>7.23</i>	<i>5.54</i>	<i>4.22</i>	<i>4.19</i>	<i>4.72</i>	<i>4.00</i>	<i>6.65</i>	<i>6.30</i>	<i>7.42</i>	5.94	10.60	38 of 38
NICKEL	<i>5.56</i>	<i>3.13</i>	<i>2.66</i>	<i>3.42</i>	<i>2.41</i>	<i>2.82</i>	<i>4.89</i>	<i>3.14</i>	<i>2.94</i>	<i>2.92</i>	<i>3.36</i>	<i>2.83</i>	3.30	8.11	38 of 38
SILVER	<i>0.39</i>	<i>0.76</i>	<i>0.90</i>	<i>0.78</i>	<i>0.80</i>	<i>0.74</i>	<i>1.38</i>	<i>1.56</i>	<i>1.00</i>	<i>1.41</i>	<i>1.69</i>	<i>0.55</i>	1.08	2.39	36 of 38
ZINC	<i>25.38</i>	<i>18.58</i>	<i>18.35</i>	<i>18.15</i>	<i>19.73</i>	<i>22.13</i>	<i>34.48</i>	<i>49.75</i>	<i>47.91</i>	<i>41.47</i>	<i>50.76</i>	<i>25.21</i>	35.22	84.20	38 of 38
Organochlorine Pesticides and PCBs (ug/L)														Times	
	Jul	Aug	Sep	Oct	Nov	Dec	Jan	Feb	Mar	Apr	May	Jun	Average	Maximum	Detected
4,4'-DDD	0.0003	0.0002	0.0003	0.0004	<i>0.0009</i>	0.0003	0.0002	0.0002	0.0004	<i>0.0007</i>	0.0002	0.0001	0.0003	0.0022	2 of 40
4,4'-DDE	0.0003	<i>0.0004</i>	<i>0.0009</i>	0.0004	<i>0.0010</i>	0.0003	0.0002	0.0002	0.0004	<i>0.0009</i>	0.0002	0.0001	0.0004	0.0026	5 of 40
4,4'-DDT	0.0003	0.0002	<i>0.0008</i>	0.0004	0.0007	0.0003	0.0002	0.0002	0.0004	<i>0.0024</i>	<i>0.0029</i>	0.0001	0.0008	0.0092	3 of 40
ALDRIN	0.0003	0.0002	0.0003	0.0004	0.0007	0.0003	0.0002	0.0002	0.0004	0.0004	0.0002	0.0001	0.0003	0.0015	0 of 40
ALPHA-BHC	~	~	~	~	0.0027	~	~	~	~	~	~	~	0.0027	0.0027	0 of 1
ALPHA-CHLORDANE	<i>0.0033</i>	0.0002	<i>0.0017</i>	0.0004	<i>0.0008</i>	0.0003	0.0002	0.0002	<i>0.0021</i>	0.0004	0.0002	0.0001	0.0009	0.0089	7 of 40
AROCLOR-1016	~	~	~	~	0.0676	~	~	~	~	~	~	~	0.0676	0.0676	0 of 1
AROCLOR-1221	~	~	~	~	0.1350	~	~	~	~	~	~	~	0.1350	0.1350	0 of 1
AROCLOR-1232	~	~	~	~	0.0676	~	~	~	~	~	~	~	0.0676	0.0676	0 of 1
AROCLOR-1242	~	~	~	~	0.0676	~	~	~	~	~	~	~	0.0676	0.0676	0 of 1
AROCLOR-1248	~	~	~	~	0.0676	~	~	~	~	~	~	~	0.0676	0.0676	0 of 1
AROCLOR-1254	~	~	~	~	0.0676	~	~	~	~	~	~	~	0.0676	0.0676	0 of 1
AROCLOR-1260	~	~	~	~	0.0676	~	~	~	~	~	~	~	0.0676	0.0676	0 of 1
BETA-BHC	~	~	~	~	0.0027	~	~	~	~	~	~	~	0.0027	0.0027	0 of 1
CHLORDANE (TECHNICAL)	~	~	~	~	0.0676	~	~	~	~	~	~	~	0.0676	0.0676	0 of 1
DELTA-BHC	~	~	~	~	0.0027	~	~	~	~	~	~	~	0.0027	0.0027	0 of 1
DIELDRIN	0.0003	0.0002	0.0003	0.0004	0.0007	0.0003	0.0002	0.0002	0.0004	0.0004	0.0002	0.0001	0.0003	0.0015	0 of 40
ENDOSULFAN I	~	~	~	~	0.0027	~	~	~	~	~	~	~	0.0027	0.0027	0 of 1
ENDOSULFAN II	~	~	~	~	0.0027	~	~	~	~	~	~	~	0.0027	0.0027	0 of 1
ENDOSULFAN SULFATE	~	~	~	~	0.0027	~	~	~	~	~	~	~	0.0027	0.0027	0 of 1
ENDRIN	0.0003	0.0002	0.0003	0.0004	0.0007	0.0003	0.0002	0.0002	0.0004	0.0004	0.0002	0.0001	0.0003	0.0015	0 of 40
ENDRIN ALDEHYDE	~	~	~	~	0.0027	~	~	~	~	~	~	~	0.0027	0.0027	0 of 1
ENDRIN KETONE	~	~	~	~	0.0027	~	~	~	~	~	~	~	0.0027	0.0027	0 of 1
GAMMA-BHC (LINDANE)	<i>0.0046</i>	<i>0.0032</i>	<i>0.0040</i>	<i>0.0038</i>	<i>0.0031</i>	0.0003	0.0002	0.0002	0.0004	0.0004	<i>0.0048</i>	<i>0.0047</i>	0.0022	0.0075	21 of 40
GAMMA-CHLORDANE	<i>0.0041</i>	<i>0.0015</i>	<i>0.0013</i>	0.0004	<i>0.0010</i>	0.0003	0.0002	0.0002	0.0004	0.0004	0.0002	0.0001	0.0008	0.0100	7 of 40
HEPTACHLOR	0.0003	0.0002	0.0003	0.0004	0.0007	0.0003	0.0002	0.0002	0.0004	0.0004	0.0002	0.0001	0.0003	0.0015	0 of 40
HEPTACHLOR EPOXIDE	0.0003	0.0002	0.0003	0.0004	0.0007	0.0003	0.0002	0.0002	0.0004	0.0004	0.0002	0.0001	0.0003	0.0015	0 of 40
METHOXYCHLOR	~	~	~	~	0.0270	~	~	~	~	~	~	~	0.0270	0.0270	0 of 1
TOXAPHENE	~	~	~	~	0.0676	~	~	~	~	~	~	~	0.0676	0.0676	0 of 1

Notes—:

DEC is Detailed Effluent Characterization project in LIMS, which includes new testing methods that are not EPA approved.

~ No samples taken

Results in *bold italics* indicate one or more detects in the month.

Yearly averages are calculated from individual results collected in the fiscal year.

Non-detected compounds are assumed to equal one half of the detection limit for metals and inorganics and one tenth of the reporting limit for organic compounds.

Appendix B

Table B-1 Cottage Farm CSO Facility Operations Summary, Fiscal Year 1999

Table B-2 Cottage Farm CSO Facility BOD and TSS Loadings, Fiscal Year 1999

Table B-3 Cottage Farm CSO Facility Effluent Characterization, Fiscal Year 1999

Table B-4 Cottage Farm CSO Facility Effluent Loadings, Fiscal Year 1999

Table B-1 Cottage Farm CSO Facility Operations Summary, Fiscal Year 1999

DATE	DISCHARGE		TOTAL VOLUME (MG)	PH (su)	BOD		TSS		SETTL. SOLIDS (mL/L)	FECAL COLIFORM (col/100 mL)	CHLORINE RESIDUAL (mg/L)	
	RAINFALL (inches)	DURATION (hours)			INFLUENT (mg/L)	EFFLUENT (mg/L)	INFLUENT (mg/L)	EFFLUENT (mg/L)				
July												
	23	0.73	3.50	9.46	7.0	160	80	278	102	0.2	< 10	2.8
August												
	17	1.52	6.00	33.49	6.9	81	63	160	126	3.0	< 10	1.7
September												
	22	1.88	3.50	34.71	7.0	55	26	116	78	0.8	< 10	2.4
October												
	9#	1.08	7.75	47.18	7.0	129	121	130	58	0.8	40	2.54
	10	1.25	5.50	11.28	7.0	132	108	110	54	0.8	< 10	2.6
	11#	0.17	4.00	1.35	7.0	80	74	42	44	0.8	~	~
November	No Activation											
December	No Activation											
January												
	3	1.51	7.75	24.97	7.0	83	56	278	77	1.2	< 10	2.34
	15*	1.67	9.50	36.84	7.0	> 222	56	87	86	4	10	2.3
	18*	0.71	6.50	32.20	7.0	66	88	172	159	4.0	< 10	2.36
	24	0.70	5.50	8.44	7.0	105	60	104	60	< .4	< 10	3.0
February												
	2*	1.29	9.50	12.99	7.0	75	71	162	132	4.0	< 10	2.91
March	No Activation											
April	No Activation											
May												
	24	0.73	6.50	5.92	7.0	112	89	116	76	< .4	< 10	2.05
June	No Activation											

Table B-1 Cottage Farm CSO Facility Operations Summary, Fiscal Year 1999, cont.

	DISCHARGE RAINFALL	DURATION	TOTAL VOLUME	PH	BOD		TSS		SETTL. SOLIDS	FECAL COLIFORM	CHLORINE RESIDUAL
	(inches)	(hours)	(MG)	(su)	INFLUENT (mg/L)	EFFLUENT (mg/L)	INFLUENT (mg/L)	EFFLUENT (mg/L)	(mL/L)	(col/100 ml)	(mg/L)
TOTAL	13.24	75.50	258.83								
AVERAGE	1.10	6.29	21.57		108	74	146	88	1.96	11	2.45
MINIMUM	0.70	3.50	1.35	6.90	55	26	42	44	0.2	<10	1.7
MAXIMUM	1.88	9.50	47.18	7.00	222	121	278	159	4.0	40	3.0
No. of Times CSO Activated			11								
No. of Days CSO Activated			13								

Table B-2 Cottage Farm CSO Facility BOD and TSS Loadings, Fiscal Year 1999

DATE	TOTAL VOLUME (MG)	BOD		TSS	
		INFLUENT (lbs/d)	EFFLUENT (lbs/d)	INFLUENT (lbs/d)	EFFLUENT (lbs/d)
July					
23	9.46	12,623	6,280	21,933	8,047
August					
17	33.49	22,652	17,652	44,689	35,193
September					
22	34.71	16,037	7,469	33,580	22,580
October					
9#	47.18	50,759	47,611	51,153	22,822
10	11.28	12,418	10,160	10,348	5,080
11#	1.35	901	835	473	495
November					
No Activation					
December					
No Activation					
January					
3	24.97	17,306	11,745	57,893	16,035
15*	36.84	68,209	17,236	26,638	26,423
18*	32.20	17,590	23,605	46,190	42,699
24	8.44	7,391	4,244	7,321	4,223
February					
2*	12.99	8,093	7,670	17,551	14,300
March					
No Activation					

Table B-2 Cottage Farm CSO Facility BOD and TSS Loadings, Fiscal Year 1999, cont.

DATE	TOTAL VOLUME (MG)	BOD		TSS	
		INFLUENT (lbs/d)	EFFLUENT (lbs/d)	INFLUENT (lbs/d)	EFFLUENT (lbs/d)
April					
	No Activation				
May					
24	5.92	5,527	4,372	8,192	3,750
June					
	No Activation				
TOTAL	258.83	239,505	158,882	325,960	201,649
AVERAGE	21.57	19958.73	13240.15	27,163	16,804
MINIMUM	1.35	901	835	473	495
MAXIMUM	47.18	68,209	47,611	57,893	42,699
No. of Times CSO Activated			11		
No. of Days CSO Activated			13		

Continued from the previous day

* Continued to following day

Table B-3 Cottage Farm CSO Facility Effluent Characterization, Fiscal Year 1999

	Jul	Aug	Sep	Oct	Nov	Dec	Jan	Feb	Mar	Apr	May	Jun	AVG	MAX	Times Detected	
Metals (ug/L)																
CADMIUM		1.00		1.00			2.12	1.00					1.28	2.12	1	of 4
COPPER		58.70		30.10			73.10	45.50					51.85	73.10	4	of 4
LEAD		32.70		28.90			95.40	38.90					48.98	95.40	4	of 4
MERCURY		0.10		0.06			0.36	0.19					0.18	0.36	4	of 4
NICKEL	N	4.00	N	4.00	N	N	8.32	3.16	N	N	N	N	4.87	8.32	2	of 4
ZINC	O	98.20	O	70.50	O	O	150.00	101.00	O	O	O	O	104.93	150.00	4	of 4
Cyanide and Phenols (ug/L)																
CYANIDE	S		S		A	A			A	A	S	A				
PHENOL	A	5.00	A	14.20	C	C	5.00	13.80	C	C	A	C	9.50	14.20	2	of 4
	M	1.00	M	1.00	T	T	10.90	1.00	T	T	M	T	3.48	10.90	1	of 4
	P		P		I	I			I	I	P	I				
Surfactants (mg/L)																
SURFACTANTS	L		L		V	V			V	V	L	V				
	E	2.18	E	0.71	A	A	1.8	ND	A	A	E	A	1.56	2.18	3	of 3
	S		S		T	T			T	T	S	T				
Organochlorine Pesticides and PCBs (ug/L)																
4,4'-DDD	T	0.003	T	0.002	O	O	0.002	0.002	O	O	T	O	0.002	0.003	0	of 4
4,4'-DDE	A	0.003	A	0.012	N	N	0.002	0.002	N	N	A	N	0.005	0.012	1	of 4
4,4'-DDT	K	0.013	K	0.016	S	S	0.018	0.002	S	S	K	S	0.012	0.018	3	of 4
METHOXYCHLOR	E	0.207	E	0.021			0.117	0.020			E		0.091	0.207	2	of 4
	N		N								N					
Semivolatile Organics (ug/L)																
4-METHYLPHENOL (INCLUDES 3-MET)		1.09		1.11			7.73	1.08					2.75	7.73	1	of 4
BENZOIC ACID		2.18		2.22			2.14	2.16					2.18	2.22	0	of 4
BENZYL ALCOHOL		1.09		1.11			1.07	1.08					1.09	1.11	0	of 4
BIS(2-ETHYLHEXYL)PHTHALATE		11.81		20.30			10.79	14.59					14.37	20.30	4	of 4
FLUORANTHENE		1.09		1.11			1.07	1.08					1.09	1.11	0	of 4
PHENANTHRENE		0.11		0.11			0.11	0.11					0.11	0.11	0	of 4

ND - No Data

Results in ***bold italics*** indicate one or more detects in the month.

Yearly averages are calculated from individual results collected in the fiscal year.

Non-detected compounds are assumed to equal one half of the detection limit for metals and inorganics and one tenth of the reporting limit for organic compounds.

Table B-4 Cottage Farm CSO Facility Effluent Loadings, Fiscal Year 1999

	Jul	Aug	Sep	Oct	Nov	Dec	Jan	Feb	Mar	Apr	May	Jun	AVG	MAX	Times Detected
Metals (lbs/day)															
CADMIUM		0.28		0.03			<i>0.44</i>	0.11					0.21	0.44	1 of 4
COPPER		<i>16.40</i>		<i>0.83</i>			<i>15.22</i>	<i>4.93</i>					9.34	16.40	4 of 4
LEAD		<i>9.13</i>		<i>0.80</i>			<i>19.87</i>	<i>4.21</i>					8.50	19.87	4 of 4
MERCURY		<i>0.03</i>		<i>0.002</i>			<i>0.07</i>	<i>0.02</i>					0.03	0.07	4 of 4
NICKEL	N	1.12	N	0.11	N	N	<i>1.73</i>	<i>0.34</i>	N	N	N	N	0.83	1.73	2 of 4
ZINC	O	<i>27.43</i>	O	<i>1.95</i>	O	O	<i>31.24</i>	<i>10.94</i>	O	O	O	O	17.89	31.24	4 of 4
Cyanide and Phenols (lbs/day)															
CYANIDE	A	1.40	A	<i>0.39</i>	C	C	1.04	<i>1.50</i>	C	C	A	C	1.08	1.50	2 of 4
PHENOL	M	0.28	M	0.03	T	T	2.27	0.11	T	T	M	T	0.67	2.27	1 of 4
	P		P		I	I			I	I	P	I			
Surfactants (lbs/day)															
SURFACTANTS	L		L		V	V			V	V	L	V			
	E	<i>608.89</i>	E	<i>19.60</i>	A	A	<i>374.85</i>	ND	A	A	E	A	334.45	608.89	3 of 3
	S		S		T	T			T	T	S	T			
Organochlorine Pesticides and PCBs (lbs/day)															
4,4'-DDD	T	0.001	T	0.0001	O	O	0.0004	0.0002	O	O	T	O	0.0004	0.001	0 of 4
4,4'-DDE	A	0.001	A	<i>0.0003</i>	N	N	0.0004	0.0002	N	N	A	N	0.0005	0.001	1 of 4
4,4'-DDT	K	<i>0.004</i>	K	<i>0.0004</i>	S	S	<i>0.0037</i>	0.0002	S	S	K	S	0.0020	0.004	3 of 4
METHOXYCHLOR	E	<i>0.058</i>	E	0.0006			<i>0.0244</i>	0.0022			E		0.0212	0.058	2 of 4
	N		N								N				
Semivolatile Organics (lbs/day)															
4-METHYLPHENOL (INCLUDES 3-MET)		0.30		0.03			<i>1.61</i>	0.12					0.52	1.61	1 of 4
BENZOIC ACID		0.61		0.06			0.45	0.23					0.34	0.61	0 of 4
BENZYL ALCOHOL		0.30		0.03			0.22	0.12					0.17	0.30	0 of 4
BIS(2-ETHYLHEXYL)PHTHALATE		<i>3.30</i>		<i>0.56</i>			<i>2.25</i>	<i>1.58</i>					1.92	3.30	4 of 4
FLUORANTHENE		0.30		0.03			0.22	0.12					0.17	0.30	0 of 4
PHENANTHRENE		0.03		0.00			0.02	0.01					0.02	0.03	0 of 4

ND - No Data

Results in *bold italics* indicate one or more detects in the month.

Appendix C

- Table C-1 Prison Point CSO Facility Operations Summary, Fiscal Year 1999
- Table C-2 Prison Point CSO Facility BOD and TSS Loadings, Fiscal Year 1999
- Table C-3 Prison Point CSO Facility Effluent Characterization, Fiscal Year 1999
- Table C-4 Prison Point CSO Facility Effluent Loadings, Fiscal Year 1999

Table C-1 Prison Point CSO Facility Operations Summary, Fiscal Year 1999

DATE	RAINFALL (inches)	DISCHARGE DURATION (hours)	TOTAL VOLUME (MG)	PH (su)	BOD		TSS		SETTL. SOLIDS (mL/L)	FECAL COLIFORM (col/100 ml)	CHLORINE RESIDUAL (mg/L)	
					INFLUENT (mg/L)	EFFLUENT (mg/L)	INFLUENT (mg/L)	EFFLUENT (mg/L)				
July												
1	0.35	2.50	5.50	~	~	~	~	~	~	~	2.0	
23	0.73	4.50	6.31	6.9	39.3	63.5	76	86	< 0.4	< 10	2.1	
31	0.61	4.00	5.50	7.1	~	~	~	~	~	~	1.5	
August												
17	1.52	6.15	30.00	7.3	49.1	37.1	164	130	1.0	10	2.0	
24	0.34	1.00	4.32	~	~	~	~	~	~	~	~	
September												
22	1.88	4.00	29.13	7.1	43	30.8	206	168	1.4	20	2.5	
October												
9#	1.08	7.50	30.00	7.2	13.4	21.3	50	52	0.4	170	1.5	
10*	1.25	7.00	20.00	7.4	< 30	31.6	84	44	0.4	< 10	1.2	
14	0.89	3.50	7.00	7.4	19.6	21.8	76	50	0.4	< 10	1.5	
November												
11	0.62	0.50	1.40	~	~	~	~	~	~	~	~	
26	0.37	2.00	4.00	6.9	> 189	184	1080	360	4.0	30	2.0	
December												
30	0.24	2.25	3.75	7.2	71.2	64.1	180	112	< 0.2	40	3.3	
January												
3	1.51	8.00	47.00	6.9	93.3	88.5	256	246	6.0	< 10	2.1	
15	1.67	8.00	51.00	7.1	143	38.6	16.7	144	2.0	< 10	2.3	
18*	0.71	7.00	40.00	7.1	61.4	50.1	211	194	2.4	30	2.6	
24	0.70	5.00	6.50	7.1	119	50.7	382	127	1.2	10	2.2	
February												
2	1.29	7.75	42.00	7.2	78.7	56.7	200	192	4.0	10	2.5	
18	0.83	4.50	4.50	7.4	125	96.3	211	170	5.0	70	2.2	
28*	0.66	7.00	9.50	7.4	46.1	67.4	96	124	3.0	< 10	2.7	
March												
4	0.38	1.50	6.00	7.3	112	29.6	330	82	0.2	< 10	3.8	
28	0.70	1.50	1.50	7.2	~	~	~	~	~	~	3.3	
April												
	No Activation											

Table C-1 Prison Point CSO Facility Operations Summary, Fiscal Year 1999, cont.

DATE	RAINFALL (inches)	DISCHARGE DURATION (hours)	TOTAL VOLUME (MG)	PH (su)	BOD		TSS		SETTL. SOLIDS (mL/L)	FECAL COLIFORM (col/100 ml)	CHLORINE RESIDUAL (mg/L)	
					INFLUENT (mg/L)	EFFLUENT (mg/L)	INFLUENT (mg/L)	EFFLUENT (mg/L)				
May												
	20	0.21	4.00	2.50	6.80	299	130	930	122	0.4	20	1.93
	24	0.73	9.50	38.50	6.90	248	74	940	196	2.0	10	1.64
	**				6.90	85	46	396	179	2.0	100	2.18
June	No Activation											
TOTAL	19.27	108.65	395.90									
AVERAGE	0.84	4.72	17.21			98.18	62.23	309.72	146.21	1.92	18.86	2.22
MINIMUM	0.21	0.50	1.40	6.80		13.4	21.3	16.7	44	<0.2	<10	1.24
MAXIMUM	1.88	9.50	51.00	7.40		299	184	1080	360	6.0	170	3.80
No. of Times CSO Activated						23						
No. of Days CSO Activated						23						

Continued from the previous day

** Multiple samples taken

~ No samples taken due to short activation

* Continued to next day

Table C-2 Prison Point CSO Facility TSS and BOD Loadings, Fiscal Year 1999

DATE	TOTAL VOLUME (MG)	BOD		TSS		
		INFLUENT (lbs/d)	EFFLUENT (lbs/d)	INFLUENT (lbs/d)	EFFLUENT (lbs/d)	
July						
1	5.50	~	~	~	~	
23	6.31	2,068	3,342	4,000	4,526	
31	5.50	~	~	~	~	
August						
17	30.00	12,285	9,282	41,033	32,526	
24	4.32	~	~	~	~	
September						
22	29.13	10,445	7,481	50,038	40,808	
October						
9#	30.00	3,353	5,329	12,510	13,010	
10*	20.00	5,004	5,271	14,011	7,339	
14	7.00	1,144	1,273	4,437	2,919	
November						
11	1.40	~	~	~	~	
26	4.00	6,305	6,138	36,029	12,010	
December						
30	3.75	2,227	2,005	5,630	3,503	
January						
3	47.00	36,572	34,690	100,347	96,427	
15	51.00	60,824	16,418	7,103	61,249	
18*	40.00	20,483	16,713	70,390	64,718	
24	6.50	6,451	2,748	20,708	6,885	
February						
2	42.00	27,567	19,861	70,056	67,254	
18	4.50	4,691	3,614	7,919	6,380	
28*	9.50	3,653	5,340	7,606	9,825	

Table C-2 Prison Point CSO Facility TSS and BOD Loadings, Fiscal Year 1999, cont.

DATE	TOTAL VOLUME (MG)	BOD		TSS	
		INFLUENT (lbs/d)	EFFLUENT (lbs/d)	INFLUENT (lbs/d)	EFFLUENT (lbs/d)
March					
4	6.00	5,604	1,481	16,513	4,103
28	1.50	~	~	~	~
April	No Activation				
May					
20	2.50	6,234	2,711	19,391	2,544
24	38.50	24,889	9,332	101,006	29,907
June	No Activation				
TOTAL	395.90	239,798	153,030	588,725	465,932
AVERAGE	17.21	13322.13	8501.68	32706.95	25885.10
MINIMUM	1.40	1144	1273	4000	2544
MAXIMUM	51.00	60824	34690	101006	96427

No. of Times CSO Activated 23
 No. of Days CSO Activated 23

Continued from the previous day
 * Continued to next day
 ~ No samples taken due to short activation

Table C-3 Prison Point CSO Facility Effluent Characterization, Fiscal Year 1999

	Jul	Aug	Sep	Oct	Nov	Dec	Jan	Feb	Mar	Apr	May	Jun	AVG	MAX	Times Detected
Metals (ug/L)															
CADMIUM	1.00	1.00	1.00	1.00	1.00		1.00	1.00	1.00		2.48		1.16	2.48	1 of 9
COPPER	150.00	147.00	52.60	27.30	93.70		70.50	70.90	50.30		123.00		87.26	150.00	9 of 9
LEAD	147.00	323.00	112.00	44.30	88.70		106.00	115.00	78.40		211.00		136.16	323.00	9 of 9
MERCURY	0.42	1.22	0.11	0.15	0.78		0.27	0.18	0.27		0.42		0.42	1.22	9 of 9
NICKEL	12.30	13.60	4.00	4.00	6.34	N	6.60	14.00	9.07	N	14.20	N	9.35	14.20	7 of 9
ZINC	310.00	343.00	120.00	83.20	255.00	O	176.00	231.00	155.00	O	349.00	O	224.69	349.00	9 of 9
Cyanide and Phenols (ug/L)															
CYANIDE	101.00	5.00	5.00	5.00	31.70	S A	30.60	38.60	5.00	A C	11.05	A C	23.90	101.00	5 of 10
PHENOL	12.65	1.00	1.00	1.00	20.00	M P L E S	1.00	24.70	11.60	T I V A T I O N	1.00	T I V A T I O N	7.76	24.70	4 of 10
Surfactants (mg/L)															
SURFACTANTS	1.06	0.69	ND	0.003	2.14		0.16	ND	0.73		1.66		0.92	2.14	6 of 7
Organochlorine Pesticides and PCBs (ug/L)															
4,4'-DDD	0.002	0.002	0.002	0.002	0.002	T	0.002	0.002	0.002	O	0.002	O	0.002	0.002	0 of 9
4,4'-DDE	0.002	0.002	0.002	0.002	0.002	A	0.002	0.002	0.002	N	0.002	N	0.002	0.002	0 of 9
4,4'-DDT	0.002	0.002	0.002	0.002	0.002	K	0.024	0.002	0.002	S	0.002	S	0.005	0.024	1 of 9
METHOXYCHLOR	0.022	0.021	0.023	0.002	0.023	E N	0.022	0.023	0.022		0.022		0.020	0.023	0 of 9
Semivolatile Organics (ug/L)															
4-METHYLPHENOL (INCLUDES 3-MET)	8.55	1.05	1.18	1.18	33.72		7.31	1.25	1.03		29.54		9.42	33.72	4 of 9
BENZOIC ACID	6.30	2.10	2.36	2.36	17.07		2.18	2.50	2.06		2.10		4.34	17.07	2 of 9
BENZYL ALCOHOL	1.07	1.05	1.18	1.18	1.22		1.09	1.25	1.03		1.05		1.12	1.25	0 of 9
BIS(2-ETHYLHEXYL)PHTHALATE	7.04	6.84	1.18	1.18	18.86		11.80	8.78	11.59		16.72		9.33	18.86	7 of 9
FLUORANTHENE	1.07	1.05	1.18	1.18	1.22		1.09	1.25	1.03		1.05		1.12	1.25	0 of 9
PHENANTHRENE	0.11	0.11	0.12	0.12	0.12		0.11	0.13	0.10		0.11		0.11	0.13	0 of 9

ND - No Data

Results in **bold italics** indicate one or more detects in the month.

Yearly averages are calculated from individual results collected in the fiscal year.

Non-detected compounds are assumed to equal one half of the detection limit for metals and inorganics and one tenth of the reporting limit for organic compounds.

Table C-4 Prison Point CSO Facility Effluent Loadings, Fiscal Year 1999

	Jul	Aug	Sep	Oct	Nov	Dec	Jan	Feb	Mar	Apr	May	Jun	AVG	MAX	Times Detected
Metals (lbs/day)															
CADMIUM	0.05	0.25	0.24	0.25	0.03		0.39	0.35	0.08		0.80		0.27	0.80	1 of 9
COPPER	7.89	36.78	12.78	6.83	3.13		27.63	24.83	3.99		39.49		18.15	39.49	9 of 9
LEAD	7.74	80.81	27.21	11.08	2.96		41.55	40.28	6.21		67.75		31.73	80.81	9 of 9
MERCURY	0.02	0.31	0.03	0.04	0.03		0.11	0.06	0.02		0.13		0.08	0.31	9 of 9
NICKEL	0.65	3.40	0.97	1.00	0.21	N	2.59	4.90	0.72	N	4.56	N	2.11	4.90	7 of 9
ZINC	16.31	85.82	29.15	20.82	8.51	O	68.99	80.91	12.28	O	112.06	O	48.32	112.06	9 of 9
Cyanide and Phenols (lbs/day)															
CYANIDE	5.32	1.25	1.21	1.25	1.06	S	11.99	13.52	0.40	A	1.99	A	3.78	13.52	5 of 10
PHENOL	0.43	0.25	0.24	0.25	0.67	M	0.39	8.65	0.92	T	0.32	T	1.24	8.65	4 of 10
Surfactants (lbs/day)															
SURFACTANTS	55.78	172.64	ND	0.75	71.39	P				I		I			
Organochlorine Pesticides and PCBs (lbs/day)															
4,4'-DDD	0.0001	0.0005	0.0005	0.0005	0.0001	L				V		V			
4,4'-DDE	0.0001	0.0005	0.0005	0.0005	0.0001	E	62.72	ND	57.84	A	533.01	A	136.30	533.01	6 of 7
4,4'-DDT	0.0001	0.0005	0.0005	0.0005	0.0001	S				T		T			
METHOXYCHLOR	0.0012	0.0053	0.0056	0.0005	0.0008	I				I		I			
Semivolatile Organics (lbs/day)															
4-METHYLPHENOL (INCLUDES 3-MET)	0.45	0.26	0.29	0.30	1.12	T	0.0008	0.0007	0.0002	O	0.0006	O	0.0004	0.0008	0 of 9
BENZOIC ACID	0.33	0.53	0.57	0.59	0.57	A	0.0008	0.0007	0.0002	N	0.0006	N	0.0004	0.0008	0 of 9
BENZYL ALCOHOL	0.06	0.26	0.29	0.30	0.04	K	0.0094	0.0007	0.0002	S	0.0006	S	0.0014	0.0094	1 of 9
BIS(2-ETHYLHEXYL)PHTHALATE	0.37	1.71	0.29	0.30	0.63	E	0.0086	0.0081	0.0017		0.0071		0.0043	0.0086	0 of 9
FLUORANTHENE	0.06	0.26	0.29	0.30	0.04	N									
PHENANTHRENE	0.01	0.03	0.03	0.03	0.004		0.04	0.05	0.01		0.04		0.03	0.05	0 of 9

ND - No Data

Results in **bold italics** indicate one or more detects in the month.

Appendix D

Table D-1 Somerville Marginal CSO Facility Operations Summary, FY 1999

Table D-2 Somerville Marginal CSO Facility BOD and TSS Loadings, FY 1999

Table D-3 Somerville Marginal CSO Facility Effluent Characterization, FY 1999

Table D-4 Somerville Marginal CSO Facility Effluent Loadings, FY 1999

Table D-1 Somerville Marginal CSO Facility Operations Summary, Fiscal Year 1999

DATE	RAINFALL (inches)	DISCHARGE		PH (su)	BOD		TSS		SETTL. SOLIDS (mL/L)	FECAL COLIFORM (col/100 ml)	CHLORINE RESIDUAL (mg/L)	
		DURATION (hours)	VOLUME (MG)		INFLUENT (mg/L)	EFFLUENT (mg/L)	INFLUENT (mg/L)	EFFLUENT (mg/L)				
July												
	23	0.73	2.00	2.17	7.0	37	37	104	230	0.6	30	2.7
August												
	17	1.52	6.00	2.68	6.6	28	12	44	52	0.4	30	3.3
September												
	15	0.62	0.50	0.25	~	~	~	~	~	~	~	~
	22	1.88	2.00	6.25	7.0	39	7	32	54	0.4	< 10	3.6
October												
	9#	1.08	6.00	10.29	7.3	21	15	56	58	0.6	< 10	3.8
	10*	1.25	4.00	1.30	7.2	< 10.3	23	32	58	1.2	< 10	3.2
	14	0.89	2.75	0.73	6.8	19	44	73	134	1.2	< 10	3.2
November												
	11	0.62	2.00	0.69	6.8	41.3	28.5	132	130	2.0	< 10	3.2
	26	0.37	8.00	0.36	6.7	121	52.2	180	134	4.0	< 10	3.8
December												
	No Activation											
January												
	3	1.51	5.00	7.09	6.8	14	25	58	131	1.6	40	3.4
	9	0.43	1.50	2.00	6.8	75	52	267	244	3.0	< 10	2.8
	15*	1.67	5.00	6.15	6.8	27	62	62	208	7.0	60	3.4
	18*	0.71	3.50	5.90	6.8	28	20	111	129	< .1	10	3.8
	24	0.70	5.00	6.00	6.8	< 40.5	42	200	188	3.0	20	3.2
February												
	2	1.29	10.00	4.03	7.0	27.5	44.3	174	198	3.0	< 10	3.7
March												
	4#	0.38	1.75	0.78	7.0	< 24.9	15.6	68	148	1.0	20	3.6
	28	0.70	0.75	0.04	~	~	~	~	~	~	~	~
April												
	No Activation											

Table D-1 Somerville Marginal CSO Facility Operations Summary, Fiscal Year 1999, cont.

DATE	RAINFALL (inches)	DISCHARGE DURATION (hours)	TOTAL VOLUME (MG)	PH (su)	BOD		TSS		SETTL. SOLIDS (mL/L)	FECAL COLIFORM (col/100 ml)	CHLORINE RESIDUAL (mg/L)
					INFLUENT (mg/L)	EFFLUENT (mg/L)	INFLUENT (mg/L)	EFFLUENT (mg/L)			
May											
	8	0.25	3.25	0.10	~	~	~	~	~	~	~
	19	0.16	1.00	0.53	6.80	55.80	56.40	200.00	318.00	3.0	30
June	No Activation										
TOTAL	16.76	70.00	57.32								
AVERAGE	0.88	3.68	3.02			38.12	33.45	112.06	150.88	2.01	16.34
MINIMUM	0.16	0.50	0.04	6.60	10.3	6.76	32	52	<0.10	<10	2.7
MAXIMUM	1.88	10.00	10.29	7.31	121	62	267	318	7.0	60	3.8

No. of Times CSO Activated 19
 No. of Days CSO Activated 19

* Continued to following day
 # Continued from the previous day
 ~ No samples taken due to short activation

Table D-2 Somerville Marginal CSO BOD and TSS Loadings, Fiscal Year 1999

DATE	TOTAL VOLUME (MG)	BOD		TSS	
		INFLUENT (lbs/d)	EFFLUENT (lbs/d)	INFLUENT (lbs/d)	EFFLUENT (lbs/d)
July					
23	2.17	675	672	1,878	4,153
August					
17	2.68	630	257	983	1,162
September					
15	0.25	~	~	~	~
22	6.25	2,034	353	1,669	2,816
October					
9#	10.29	1,793	1,244	4,804	4,976
10*	1.30	111	243	346	627
14	0.73	118	270	445	817
November					
11	0.69	238	164	760	748
26	0.36	358	155	533	397
December					
	No Activation				
January					
3	7.09	840	1,496	3,430	7,747
9	2.00	1,244	871	4,454	4,070
15*	6.15	1,359	3,201	3,181	10,670
18*	5.90	1,398	970	5,463	6,349
24	6.00	2,027	2,092	10,008	9,408
February					
2	4.03	925	1,490	5,851	6,658
March					
4*	0.78	161	101	440	957
28	0.04	~	~	~	~

Table D-2 Somerville Marginal CSO BOD and TSS Loadings, Fiscal Year 1999, cont.

DATE	TOTAL VOLUME (MG)	BOD		TSS	
		INFLUENT (lbs/d)	EFFLUENT (lbs/d)	INFLUENT (lbs/d)	EFFLUENT (lbs/d)
April					
	No Activation				
May					
	8	0.10	~	~	~
	19	0.53	246	248	881
June					
	No Activation				
TOTAL	57.32	14157	13825	45124	62955
AVERAGE	3.02	885	864	2820	3935
MINIMUM	0.04	111	101	346	397
MAXIMUM	10.29	2034	3201	10008	10670

No. of Times CSO Activated 19
 No. of Days CSO Activated 19

Continued from the previous day
 * Continued to next day
 ~ No samples taken due to short activation

Table D-3 Somerville Marginal CSO Facility Effluent Characterization, Fiscal Year 1999

	Jul	Aug	Sep	Oct	Nov	Dec	Jan	Feb	Mar	Apr	May	Jun	AVG	MAX	Times Detected
Metals (ug/L)															
CADMIUM		1.00	1.00	1.00			1.00	1.00					1.00	1.00	0 of 5
COPPER		34.80	20.40	6.00			43.40	28.90					26.70	43.40	4 of 5
LEAD		66.00	37.80	19.20			126.00	52.50					60.30	126.00	5 of 5
MERCURY		0.16	0.09	0.03			0.12	0.08					0.10	0.16	5 of 5
NICKEL	N	8.74	4.00	4.00	N	N	10.30	3.36	N	N	N	N	6.08	10.30	3 of 5
ZINC	O	112.00	86.90	46.60	O	O	170.00	145.00	O	O	O	O	112.10	170.00	5 of 5
Cyanide and Phenols (ug/L)															
CYANIDE	A	5.00	5.00	5.00	A	C	5.00	11.50	A	C	A	C	6.30	11.50	1 of 5
PHENOL	M	1.00	1.00	1.00	M	T	1.00	27.50	M	T	M	T	7.76	27.50	1 of 5
Surfactants (mg/L)															
SURFACTANTS	E	0.73	ND	0.003	E	A	0.44	ND	E	A	E	A	0.39	0.73	2 of 3
Organochlorine Pesticides and PCBs (ug/L)															
4,4'-DDD	T	0.004	0.002	0.002	T	O	0.002	0.002	T	O	T	O	0.003	0.004	0 of 5
4,4'-DDE	A	0.004	0.002	0.002	A	N	0.002	0.002	A	N	A	N	0.003	0.004	0 of 5
4,4'-DDT	K	0.004	0.002	0.002	K	S	0.002	0.002	K	S	K	S	0.003	0.004	0 of 5
METHOXYCHLOR	E	0.037	0.024	0.024	E		0.022	0.022	E		E		0.026	0.037	0 of 5
Semivolatile Organics (ug/L)															
4-METHYLPHENOL (INCLUDES 3-MET)		1.25	1.25	1.18			1.03	1.06					1.15	1.25	0 of 5
BENZOIC ACID		2.50	2.50	2.36			2.06	2.12					2.31	2.50	0 of 5
BENZYL ALCOHOL		1.25	1.25	1.18			1.03	1.06					1.15	1.25	0 of 5
BIS(2-ETHYLHEXYL)PHTHALATE		6.75	7.63	1.18			1.03	6.09					4.54	7.63	3 of 5
FLUORANTHENE		1.25	1.25	1.18			1.03	1.06					1.15	1.25	0 of 5
PHENANTHRENE		0.13	0.13	0.11			0.10	0.11					0.12	0.13	0 of 5

ND - No Data

Results in **bold italics** indicate one or more detects in the month.

Yearly averages are calculated from individual results collected in the fiscal year.

Non-detected compounds are assumed to equal one half of the detection limit for metals and inorganics and one tenth of the reporting limit for organic compounds.

Table D-4 Somerville Marginal CSO Facility Effluent Loadings, Fiscal Year 1999

	Jul	Aug	Sep	Oct	Nov	Dec	Jan	Feb	Mar	Apr	May	Jun	AVG	MAX	Times Detected
Metals (lbs/day)															
CADMIUM		0.02	0.05	0.09			0.06	0.03					0.05	0.09	0 of 5
COPPER		<i>0.78</i>	<i>1.06</i>	0.51			<i>2.57</i>	<i>0.97</i>					1.18	2.57	4 of 5
LEAD		<i>1.48</i>	<i>1.97</i>	<i>1.65</i>			<i>7.45</i>	<i>1.76</i>					2.86	7.45	5 of 5
MERCURY		<i>0.004</i>	<i>0.005</i>	<i>0.003</i>			<i>0.01</i>	<i>0.003</i>					0.004	0.01	5 of 5
NICKEL	N	<i>0.20</i>	0.21	0.34	N	N	<i>0.61</i>	<i>0.11</i>	N	N	N	N	0.29	0.61	3 of 5
ZINC	O	<i>2.50</i>	<i>4.53</i>	<i>4.00</i>	O	O	<i>10.05</i>	<i>4.87</i>	O	O	O	O	5.19	10.05	5 of 5
Cyanide and Phenols (lbs/day)															
CYANIDE	A	0.11	0.26	0.43	A	C	0.30	<i>0.39</i>	A	C	A	C	0.30	0.43	1 of 5
PHENOL	M	0.02	0.05	0.09	M	T	0.06	<i>0.92</i>	M	T	M	T	0.23	0.92	1 of 5
Surfactants (lbs/day)															
SURFACTANTS	E	<i>16.32</i>	ND	0.26	E	A	<i>26.02</i>	ND	E	A	E	A	14.20	26.02	2 of 3
Organochlorine Pesticides and PCBs (lbs/day)															
4,4'-DDD	T	0.0001	0.0001	0.0002	T	O	0.0001	0.0001	T	O	T	O	0.0001	0.0002	0 of 5
4,4'-DDE	A	0.0001	0.0001	0.0002	A	N	0.0001	0.0001	A	N	A	N	0.0001	0.0002	0 of 5
4,4'-DDT	K	0.0001	0.0001	0.0002	K	S	0.0001	0.0001	K	S	K	S	0.0001	0.0002	0 of 5
METHOXYCHLOR	E	0.0008	0.0013	0.0021	E		0.0013	0.0007	E		E		0.0012	0.0021	0 of 5
Semivolatile Organics (lbs/day)															
4-METHYLPHENOL (INCLUDES 3-MET)		0.03	0.07	0.10			0.06	0.04					0.06	0.10	0 of 5
BENZOIC ACID		0.06	0.13	0.20			0.12	0.07					0.12	0.20	0 of 5
BENZYL ALCOHOL		0.03	0.07	0.10			0.06	0.04					0.06	0.10	0 of 5
BIS(2-ETHYLHEXYL)PHTHALATE		<i>0.15</i>	<i>0.40</i>	0.10			0.06	<i>0.20</i>					0.18	0.40	3 of 5
FLUORANTHENE		0.03	0.07	0.10			0.06	0.04					0.06	0.10	0 of 5
PHENANTHRENE		0.00	0.01	0.01			0.01	0.00					0.01	0.01	0 of 5

ND - No Data

Results in *bold italics* indicate one or more detects in the month.

Appendix E

Table E-1 Constitution Beach CSO Facility Operations Summary, FY 1999

Table E-2 Constitution Beach CSO Facility BOD and TSS Loadings, FY 1999

Table E-1 Constitution Beach CSO Facility Operations Summary, Fiscal Year 1999

DATE	RAINFALL (inches)	DISCHARGE DURATION (hours)	TOTAL VOLUME (MG)	PH (su)	BOD		TSS		SETTL. SOLIDS (mL/L)	FECAL COLIFORM (col/100 ml)	CHLORINE RESIDUAL (mg/L)
					INFLUENT (mg/L)	EFFLUENT (mg/L)	INFLUENT (mg/L)	EFFLUENT (mg/L)			
July											
23	0.73	0.15	0.05	~	~	~	~	~	~	~	~
August											
17	1.52	4.00	0.36	~	~	~	~	~	~	~	~
September											
15	0.62	0.25	0.05	~	~	~	~	~	~	~	~
22	1.88	1.75	0.29	~	~	~	~	~	~	~	~
October											
10	1.25	2.75	0.08	~	~	~	~	~	~	~	~
14	0.89	2.00	0.09	~	~	~	~	~	~	~	~
November											
11	0.62	0.50	0.10	~	~	~	~	~	~	~	~
December											
	No Activation										
January											
3	1.51	3.25	0.16	\$	\$	\$	\$	\$	\$	\$	\$
9	0.43	0.25	0.02	~	~	~	~	~	~	~	~
15	1.67	5.25	0.02	7.5	58.9	78.7	34	52	0.4	<10	3.2
18	0.71	2.50	0.02	7.6	< 16.4	8.1	79	82	0.2	<10	2.8
24	0.70	0.50	0.02	~	~	~	~	~	~	~	~
February											
2	1.29	3.00	0.26	~	~	~	~	~	~	~	~
March											
4	0.38	0.75	0.12	~	~	~	~	~	~	~	~
28	0.70	0.25	0.13	~	~	~	~	~	~	~	~
April											
	No Activation										

Table E-1 Constitution Beach CSO Facility Operations Summary, Fiscal Year 1999, cont.

DATE	RAINFALL (inches)	DISCHARGE DURATION (hours)	TOTAL VOLUME (MG)	PH (su)	BOD		TSS		SETTL. SOLIDS (mL/L)	FECAL COLIFORM (col/100 ml)	CHLORINE RESIDUAL (mg/L)
					INFLUENT (mg/L)	EFFLUENT (mg/L)	INFLUENT (mg/L)	EFFLUENT (mg/L)			
May	No Activation										
June	No Activation										
TOTAL	14.9	27.15	1.76								
AVERAGE	0.99	1.81	0.12		37.7	43.40	56.5	67	0.3	10	3
MINIMUM	0.38	0.15	0.02	7.48	<16.4	8.09	34	52	0.20	<10	2.8
MAXIMUM	1.88	5.25	0.36	7.56	58.9	78.7	79	82	0.40	<10	3.2
No. of Times CSO Activated			15								
No. of Days CSO Activated			15								

~ No samples taken; station shut down upon arrival at the facility or short activation

\$ No samples taken due to system malfunction

Table E-2 Constitution Beach CSO BOD and TSS Loadings, Fiscal Year 1999

DATE	TOTAL VOLUME (MG)	BOD		TSS	
		INFLUENT (lbs/d)	EFFLUENT (lbs/d)	INFLUENT (lbs/d)	EFFLUENT (lbs/d)
July					
23	0.05	~	~	~	~
August					
17	0.36	~	~	~	~
September					
15	0.25	~	~	~	~
22	6.25	2034	353	1669	2816
October					
10	0.08	~	~	~	~
14	0.09	~	~	~	~
November					
11	0.10	~	~	~	~
December					
	No Activation				
January					
3	0.16	~	~	~	~
9	0.02	~	~	~	~
15	0.02	11	14	6	10
18	0.02	3	1	13	14
24	0.02	~	~	~	~
February					
2	0.26	~	~	~	~

Table E-2 Constitution Beach CSO BOD and TSS Loadings, Fiscal Year 1999, cont.

DATE	TOTAL VOLUME (MG)	BOD		TSS	
		INFLUENT (lbs/d)	EFFLUENT (lbs/d)	INFLUENT (lbs/d)	EFFLUENT (lbs/d)
March					
4	0.12	~	~	~	~
28	0.126	~	~	~	~
April	No Activation				
May	No Activation				
June	No Activation				
TOTAL	7.92	2047.49	368.34	1688.30	2839.45
AVERAGE	0.53	682.50	122.78	562.77	946.48
MINIMUM	0.02	2.74	1.35	6.24	9.54
MAXIMUM	6.25	2033.95	352.55	1668.88	2816.24
No. of Times CSO Activated		15			
No. of Days CSO Activated		15			

~ No samples taken; station shut down upon arrival at the facility or short activation

Appendix F

Table F-1 Fox Point CSO Facility Operations Summary, Fiscal Year 1999

Table F-2 Fox Point CSO Facility BOD and TSS Loadings, Fiscal Year 1999

Table F-1 Fox Point CSO Facility Operations Summary, Fiscal Year 1999

DATE	DISCHARGE		TOTAL VOLUME (MG)	PH (su)	BOD		TSS		SETTL. SOLIDS (mL/L)	FECAL COLIFORM (col/100 ml)	CHLORINE RESIDUAL (mg/L)	
	RAINFALL (inches)	DURATION (hours)			INFLUENT (mg/L)	EFFLUENT (mg/L)	INFLUENT (mg/L)	EFFLUENT (mg/L)				
July												
	23	0.73	0.45	0.31	~	~	~	~	~	~	~	
August												
	17	1.52	4.00	14.80	6.8	21.2	33.2	76	98	2.0	10	4.3
September												
	22	1.88	3.00	12.99	6.8	> 188	15	2900	124	0.6	< 10	2.8
October												
	8	1.85	6.25	11.61	7.4	36	56	96	86	0.8	60	
	10	1.25	4.75	7.05	7.4	29	34	42	100	1.2	< 10	4.5
	14	0.89	0.75	1.46	~	~	~	~	~	~	~	
November												
	11	0.62	0.50	0.66	~	~	~	~	~	~	~	
December												
	No Activation											
January												
	15	1.67	9.00	0.78	7.75	44.4	80.1	66	66	1.0	< 10	2.70
	18	0.71	2.00	6.01	~	~	~	~	~	~	~	
February												
	2	1.29	3.50	2.64	7.2	54	62	184	142	1.8	< 10	3.7
	18	0.83	0.5	0.5	~	~	~	~	~	~	~	
March												
	4	0.38	0.5	0.489	~	~	~	~	~	~	~	
April												
	No Activation											

Table F-1 Fox Point CSO Facility Operations Summary, Fiscal Year 1999, cont.

DATE	DISCHARGE		TOTAL VOLUME (MG)	PH (su)	BOD		TSS		SETTL. SOLIDS (mL/L)	FECAL COLIFORM (col/100 ml)	CHLORINE RESIDUAL (mg/L)
	RAINFALL (inches)	DURATION (hours)			INFLUENT (mg/L)	EFFLUENT (mg/L)	INFLUENT (mg/L)	EFFLUENT (mg/L)			
May	No Activation										
June	No Activation										
TOTAL	13.62	35.20	59.30								
AVERAGE	1.14	2.93	4.94		62.15	46.68	560.67	102.67	1.23	13.48	3.60
MINIMUM	0.38	0.45	0.31	6.80	21.2	14.8	42	66	0.6	<10	2.70
MAXIMUM	1.88	9.00	14.80	7.75	188	80.1	2900	142	2	60	4.50
No. of Times CSO Activated			12								
No. of Days CSO Activated			12								

~ No samples taken; station shut down upon arrival at the facility or short activation

Table F-2 Fox Point CSO BOD and TSS Loadings, Fiscal Year 1999

DATE	TOTAL VOLUME (MG)	BOD		TSS	
		INFLUENT (lbs/d)	EFFLUENT (lbs/d)	INFLUENT (lbs/d)	EFFLUENT (lbs/d)
July					
23	0.31	~	~	~	~
August					
17	14.80	2,617	4,099	9,383	12,099
September					
22	12.99	20,367	1,603	314,176	13,434
October					
8	11.61	3,505	5,392	9,294	8,326
10	7.05	1,728	1,998	2,468	5,876
14	0.99	~	~	~	~
November					
11	0.66	~	~	~	~
December					
	No Activation				
January					
15	0.78	288	520	429	429
18	6.014	~	~	~	~
February					
2	2.642	1,183	1,373	4,054	3,129
18	0.5	~	~	~	~
March					
4	0.489	~	~	~	~

Table F-2 Fox Point CSO BOD and TSS Loadings, Fiscal Year 1999, cont.

DATE	TOTAL VOLUME (MG)	BOD		TSS	
		INFLUENT (lbs/d)	EFFLUENT (lbs/d)	INFLUENT (lbs/d)	EFFLUENT (lbs/d)
April	No Activation				
May	No Activation				
June	No Activation				
TOTAL	58.83	29688	14986	339804	43292
AVERAGE	4.90	4948	2498	56634	7215
MINIMUM	0.31	288	520	429	429
MAXIMUM	14.80	20367	5392	314176	13434
No. of Times CSO Activated		12			
No. of Days CSO Activated		12			

~ No samples taken; station shut down upon arrival at the facility or short activation

Appendix G

Table G-1 Commercial Point CSO Facility Operations Summary, FY 1999

Table G-2 Commercial Point CSO Facility BOD and TSS Loadings, FY 1999

Table G-1 Commercial Point CSO Facility Operations Summary, Fiscal Year 1999

DATE	RAINFALL (inches)	DISCHARGE DURATION (hours)	TOTAL VOLUME (MG)	PH (su)	BOD		TSS		SETTL. SOLIDS (mL/L)	FECAL COLIFORM (col/100 ml)	CHLORINE RESIDUAL (mg/L)	
					INFLUENT (mg/L)	EFFLUENT (mg/L)	INFLUENT (mg/L)	EFFLUENT (mg/L)				
July												
	23	0.73	1.15	0.41	~	~	~	~	~	~	~	
August												
	17	1.52	4.00	7.14	7.0	40.3	68.9	194.0	354.0	1.4	120	3.0
September												
	15	0.62	0.25	0.28	~	~	~	~	~	~	~	
	22	1.88	4.00	2.22	~	~	~	~	~	~	~	
October												
	9#	1.08	7.00	10.94	7.0	< 21.4	7	21	18	< .2	< 10	2.8
	10	1.25	3.25	5.52	7.6	11	12	24	28	< .4	< 10	4.1
	14	0.89	0.85	0.89								
November												
	11	0.62	0.75	0.98	~	~	~	~	~	~	~	
	26	0.37	0.50	0.21	~	~	~	~	~	~	~	
December												
	No Activation											
January												
	3	1.51	3.00	3.70	\$	\$	\$	\$	\$	\$	\$	
	9	0.43	0.25	0.53	~	~	~	~	~	~	~	
	15	1.67	9.75	12.39	7.9	24	45	83	136	4	< 10	2.5
	18	0.71	2.25	5.93	7.1	< 27.4	17	298	155	1	20	3.4
	24	0.70	2.50	1.41	8.4	46	97	2290	33	< .2	< 10	3.0
February												
	2	1.29	3.00	4.90	~	~	~	~	~	~	~	
	18	0.83	2.00	1.32	~	~	~	~	~	~	~	
March												
	4	0.38	1.00	1.22	~	~	~	~	~	~	~	
	28	0.70	0.25	2.43	~	~	~	~	~	~	~	
April												
	17#	0.04	0.25	0.10	~	~	~	~	~	~	~	

Table G-1 Commercial Point CSO Facility Operations Summary, Fiscal Year 1999, cont.

DATE	DISCHARGE		TOTAL VOLUME (MG)	PH (su)	BOD		TSS		SETTL. SOLIDS (mL/L)	FECAL COLIFORM (col/100 ml)	CHLORINE RESIDUAL (mg/L)
	RAINFALL (inches)	DURATION (hours)			INFLUENT (mg/L)	EFFLUENT (mg/L)	INFLUENT (mg/L)	EFFLUENT (mg/L)			
May	8	0.25	0.25	~	~	~	~	~	~	~	~
June	No Activation										
TOTAL	17.47	46.25	62.78								
AVERAGE	0.92	2.42	3.30		28.28	41.21	485	120.67	1.17	30	3.13
MINIMUM	0.25	0.25	0.10	7.00	11.2	7.34	21	18	<0.2	<10	2.50
MAXIMUM	1.88	9.75	12.39	8.35	45.8	97.2	2290	354	4.0	120	4.10

No. of Times CSO Activated 20
 No. of Days CSO Activated 20

Continued from the previous day
 ~ No samples taken; station shut down upon arrival at the facility or short activation
 \$ No samples taken due to system malfunction

Table G-2 Commercial Point CSO BOD and TSS Loadings, Fiscal Year 1999

DATE	TOTAL VOLUME (MG)	BOD		TSS	
		INFLUENT (lbs/d)	EFFLUENT (lbs/d)	INFLUENT (lbs/d)	EFFLUENT (lbs/d)
July					
23	0.41	~	~	~	~
August					
17	7.14	2,398	4,101	11,546	21,068
September					
15	0.28	~	~	~	~
22	2.22	~	~	~	~
October					
9#	7.00	1,249	429	1,226	1,051
10	3.25	304	323	651	759
14	0.89				
November					
11	0.98	~	~	~	~
26	0.21	~	~	~	~
December					
	No Activation				
January					
3	3.70	~	~	~	~
9	0.53	~	~	~	~
15	12.39	2,439	4,599	8,578	14,056
18	5.93	1,355	860	14,735	7,664
24	1.41	539	1,145	26,967	389

Table G-2 Commercial Point CSO BOD and TSS Loadings, Fiscal Year 1999, cont.

DATE	TOTAL VOLUME (MG)	BOD		TSS		
		INFLUENT (lbs/d)	EFFLUENT (lbs/d)	INFLUENT (lbs/d)	EFFLUENT (lbs/d)	
February						
2	4.90	~	~	~	~	
18	1.32	~	~	~	~	
March						
4	1.22	~	~	~	~	
28	2.43	~	~	~	~	
April						
17#	0.10	~	~	~	~	
May						
8	0.25	~	~	~	~	
June						
	No Activation					
<hr/>						
TOTAL	56.56	8285	11456	63703	44986	
AVERAGE	2.83	1381	1909	10617	7498	
MINIMUM	0.10	304	323	651	389	
MAXIMUM	12.39	2439	4599	26967	21068	

No. of Times CSO Activated 20

No. of Days CSO Activated 20

Continued from the previous day

~ No samples taken; station shut down upon arrival at the facility or short activation

Appendix H

NPDES Monitoring Requirements

The Environmental Protection Agency (EPA) mandates that any discharge to a body of water must be permitted through the National Pollutant Discharge Elimination System (NPDES). The EPA and the Massachusetts Department of Environmental Protection (DEP) jointly issued a NPDES permit to MWRA for the Deer Island treatment plant and three CSO treatment facilities, Cottage Farm, Prison Point, and Somerville Marginal. MWRA also owns and operates three additional CSO facilities, Constitution Beach, Fox Point, and Commercial Point. The effluent from these three gravity CSO facilities discharges to the City of Boston sewer lines. Thus, the Boston Water and Sewer Commission (BWSC) NPDES permit allows for the ultimate discharge of the effluent from those facilities.

The limits set in the MWRA NPDES permit are limitations for secondary treatment plants. MWRA currently operates under court-ordered interim limits while the upgrade of the Deer Island secondary treatment plant is being completed. A new NPDES permit is expected to become effective in FY00.

In addition, MWRA, through the NPDES Pretreatment Program, monitors the influent quality of wastewater. Those monitoring results provide the basis for determining the adequacy of existing Local Limits to protect the treatment plants and Boston Harbor. Local Limits allow the discharge of toxic chemicals from industrial sources to be regulated. Current Local Limits were enacted in FY94 and, under the Pretreatment Program requirements, must be re-evaluated every five years.

MWRA not only monitors to comply with the NPDES requirements, but also has its own monitoring programs, including Plant Monitoring and Receiving Water Monitoring. These monitoring programs serve to assure appropriate control of discharges to the system, to assure the most cost-effective wastewater treatment while meeting water quality standards, and to assure the quality of life of the organisms and health of the animal communities living in the receiving bodies of water.

H.1 Permits and Compliance Order

H.1.a NPDES Permit

Under the NPDES permit, “in compliance with the provisions of the Clean Water Act, as amended, 33 U.S.C. § 1251 et seq., and the Massachusetts Clean Water Act, as amended, Mass. Gen. Laws, ch. 21, § 266-53, the MWRA is permitted to discharge from (MWRA Publicly Owned Treatment Works, CSO Treatment Facilities, and CSO Outfalls), in accordance with effluent limitations, monitoring limitations, and other conditions...”

Monitoring Requirements and Effluent Limitations: The NPDES permit establishes monitoring requirements for existing POTW outfalls as well as for CSO treatment facility outfalls. In addition, the permit mandates CSO outfall identification and receiving water monitoring. It also establishes numerical limitations for certain parameters as well as narrative limits for all authorized discharges.

Reporting Requirements: In addition to POTW and CSO monitoring requirements, the NPDES permit requires certain reports on the state of MWRA sewerage and operational systems. These include the Infiltration/Inflow Report, CSO Facilities and Systems Inspection, reports on operational upsets, Overflow Reports, Operations Bypass Reports, Monthly Discharge Monitoring Reports (DMRs), and reporting on the effects of discharges (Annual Bioaccumulation Study). Table H-1 presents a summary of the permit limits and monitoring requirements for POTWs while Table H-2 presents permit limits for CSOs.

H.1.b Court Order

MWRA also operates under a court order issued in June 1986. In addition to establishing interim discharge limits for the treatment plant, the court order established a schedule for MWRA to upgrade the sewerage system and treatment plant. Table H-3 summarizes the court-ordered interim limits for the Deer Island Treatment Plant.

Table H-1

NPDES PERMIT Effluent Limitations and Monitoring Requirements for POTW Outfalls Deer Island Treatment Plant			
Effluent Characteristic	Discharge Limitation		
	Average Monthly	Average Weekly	Maximum Daily
BOD	*	*	*
TSS	*	*	*
Settleable Solids	*	*	*
pH	Not less than 6.5 nor greater than 8.5 at any time to Boston Harbor, Quincy Bay, Hingham Bay, the Inner Harbor and the Mystic River.		
Fecal Coliform	*	*	*
Total Coliform	*	*	*
Chlorine, Total Residual	(1) The total chlorine residual and other toxic components of the effluent shall not result in any demonstrable harm to aquatic life or violate any state or federal water quality standard which has been or may be promulgated. Upon promulgation of any such standards, this permit may be modified in accordance with such standards. (2) The permittee shall minimize the use of chlorine, still maintaining adequate bacterial control.		
Oil and Grease of Petroleum Origin (also called TPH or PHC)	N/A	N/A	15 mg/L

* Court ordered interim limit applies to this parameter.

Table H-1 [cont.]

NPDES PERMIT Effluent Limitations and Monitoring Requirements for POTW Outfalls Deer Island Treatment Plant	
Effluent Characteristic	Discharge Limitation
NOEC ^a	10% or greater (10% or more of the sample is composed of effluent; remainder is dilution water) Chronic toxicity tests to establish the NOEC (No Observed Effect Concentration): Chronic toxicity tests on representative 24-hour composite samples of the discharge using each of the following organisms: (i) the sheepshead minnow, <i>Cyprinodon variegatus</i> (7-day tests to measure growth and survival); and (ii) the red marine alga, <i>Champia parvula</i> (multi-day tests to evaluate the effects on sexual reproduction).
NOAEL ^b and LC50 ^c	Acute static toxicity tests to establish the NOAEL (No Observed Acute Effect Level) and LC50 of the effluent: 96-hour acute static toxicity tests on representative 24-hour composite samples of the discharge using one to five-day-old juvenile mysid shrimp, <i>Mysidopsis bahia</i> .
NOAEL	20% or greater (20% or more of the sample is composed of effluent)
Other Monitored Parameters	Pollutants listed in 40 CFR Part 122 Appendix D. (See Table L-3 of Appendix L in this report.)

^a NOEC: No Observed Effect Concentration is the highest concentration of effluent to which organisms are exposed in a life cycle or partial life cycle test which has no adverse effects (on growth, survival and reproduction).

^b NOAEL: No Observed Acute Effect Level is the highest concentration of effluent to which organisms are exposed in a short-term test in which at least 90% of the test organisms survive.

^c LC50: the concentration of effluent in a sample that causes mortality in 50% of the test population at a specific time of observation.

Table H-2

NPDES PERMIT Effluent Limitations and Monitoring Requirements for CSO Treatment Facility Outfalls	
Characteristic	Discharge Limitation
pH	The pH of the effluent shall not be (1) less than 6.5 nor greater than 8.5 at any time to the Inner Harbor and Mystic River (2) less than 6.5 nor greater than 9.0 at any time to the Charles River
Fecal Coliform	(1) Maximum monthly geometric mean: 1000 col/100 mL (2) Not more than 10% of the total samples can exceed 2500 col/100 mL during any monthly sampling period.
Chlorine, Total Residual	(1) The total chlorine residual and other toxic components of the effluent shall not result in any demonstrable harm to aquatic life or violate any state or federal water quality standard which has been or may be promulgated. Upon promulgation of any such standard, this permit may be modified in accordance with such standard. (2) The permittee shall minimize the use of chlorine, still maintaining adequate bacterial control.
Other Monitored Parameters	
Rainfall/Precipitation	
Flow	
BOD ^a	
TSS ^a	
Settleable Solids	

^a Report both influent and effluent results for this parameter.

Table H-2 [cont.]

NPDES PERMIT Effluent Limitations and Monitoring Requirements for CSO Treatment Facility Outfalls
NOAEL ^b
LC50 ^b
Cadmium ^c
Chromium (Hexavalent) ^c
Copper ^c
Lead ^c
Mercury ^c
Nickel ^c
Zinc ^c
Chlorinated Hydrocarbons ^c
Ammonia Nitrogen ^c
Total Phosphorus ^c
Pesticides ^c
PAHs ^c
VOCs ^c

^b Only required to be monitored in the first and fifth year of the permit. Has not been monitored since the permit expired.

^c Only required to be monitored in the first and fifth year of the permit, although MWRA has been continually monitoring these parameters since the start of the permit.

Table H-3

COURT ORDERED SEWAGE TREATMENT PLANT INTERIM LIMITATIONS			
Effluent Characteristic	Effluent Limits		
	Average Monthly	Maximum Daily	Percent Removal*
BOD	140 mg/L	200 mg/L	27%
TSS	110 mg/L	180 mg/L	38%
Settleable Solids	2.8 mL/L	N/A	N/A
Fecal Coliform	200 col/100 mL	N/A	N/A
Total Coliform	1000 col/100 mL	N/A	N/A
pH	The pH of the effluent shall not be less than 6.5 nor greater than 8.5 at any time unless these values are exceeded due to natural causes or as a result of approved modifications of treatment processes.		

* Percent Removal is based on a 12-month running average.

Table H-3 [cont.]

COURT ORDERED SEWAGE TREATMENT PLANT INTERIM LIMITATIONS	
Other Effluent Limitations	
Chlorine	The Authority shall minimize the use of chlorine consistent with maintaining adequate bacterial control.
Reduction of Suspended Solids	Volatile suspended solids shall be reduced through anaerobic digestion, with percentage reductions to be computed as a two month rolling average (50%).
Special Monitoring of Oil and Grease	The Authority shall separately measure the concentration of the following by means of a weekly grab sample: Influent oil and grease, effluent oil and grease, digester sludge influent oil and grease, and digester sludge effluent oil and grease.

H.2 Monitoring Programs

In FY99, MWRA conducted several monitoring programs. However, this report will present only the influent and effluent monitoring programs. The report will also include information on the “critical areas” in MWRA and community sewer systems that have historically discharged during and after heavy rainstorms. These “critical areas” were monitored and inspected as part of the NPDES monitoring program.

H.2.a Treatment Plant Monitoring Program

The Treatment Plant Monitoring Program has two main components: The Influent Monitoring Program and the Effluent Monitoring Program.

The Influent Monitoring Program characterizes the influent to the Deer Island Treatment Plant. Influent monitoring for conventional parameters, in addition to being mandated by the NPDES permit, is also necessary for process control. Data from the Influent Monitoring Program provide

influent loading rates and the basis for determining treatment plant efficiency. In addition, influent monitoring for non-conventional parameters is mandated by the NPDES Permit Pretreatment Program.

The Effluent Monitoring Program characterizes the quality of the effluent discharged to a receiving body of water. Except for whole effluent toxicity (WET) testing, the parameters measured in the effluent are the same as those measured in the influent. The NPDES permit requires effluent monitoring and imposes permit limits to ensure the health of the receiving water.

Table H-4 lists the treatment plant monitoring program parameters, including sample type, sampling frequency and analytical procedures used.

H.2.b Combined Sewer Overflow Facilities Monitoring Program

The CSO Monitoring Program includes influent and effluent monitoring at the six CSO facilities, although only three of them are currently included in the MWRA NPDES permit. Influent and effluent samples are collected and tested for conventional parameters at all six CSO facilities. For the permitted facilities, in addition to conventional parameters, select priority pollutants are also analyzed in the effluent. Table H-5 lists the CSO monitoring program parameters, including sample type, sampling frequency and analytical procedures used.

H.2.c Sewer System Monitoring Program

The Sewer System Monitoring Program, which attempts to identify Sanitary Sewer Overflows (SSOs), involves conducting visual inspections of areas in the sewer system that have a history of discharging during or shortly after a heavy rainfall event. Because of the hydraulics of the South System, discharges occur in manholes or other low-lying areas, while discharges in the North System are the result of combined sewage overwhelming sewage system capacity.

H.3 Treatment of Results

It can be difficult to interpret laboratory results and to ensure that they are representative of the sample, especially when the results are at or below method detection levels. For the conventional parameters measured in these monitoring programs, calculating the average concentration of a particular parameter was straightforward: the arithmetic average was used. However, the concentrations of metals, pesticides and organics are very frequently below method detection levels, and data were manipulated. Appendix J gives a brief description of method detection limits and how measurements below detection limits are treated in this report.

Daily loadings were calculated using the formula:

$$\text{Loadings (lbs/day)} = Q * C * 8.34$$

where Q= flow (mgd)

C = concentration (mg/L)

8.34 = unit conversion factor

Monthly average concentrations for priority pollutants (metals, cyanide, pesticides/PCBs and organic compounds) were calculated by adding the loadings of the pollutant during each sampling event for that month and then dividing it by the total flow during those sampling events.

Average annual concentrations were calculated using the same method, taking each individual sampling event into account in the calculation.

It should be kept in mind that with the large flows going through the Deer Island Treatment Plant, taking one small sample may not always be truly representative. It is also important to keep in mind that certain parameters (conventional) were analyzed daily while other parameters (priority pollutants) were analyzed only two or three times per month.

Table H-4
POTW Monitoring Program

Parameter	Sample Type ¹	Sampling Frequency		Analytical Method ²
		Influent	Effluent	
Metals				
Antimony	Composite	8 x per month	8 x per month	204.2
Arsenic	Composite	8 x per month	8 x per month	206.2
Beryllium	Composite	8 x per month	8 x per month	200.7
Boron	Composite	8 x per month	8 x per month	200.7
Cadmium	Composite	8 x per month	8 x per month	213.1
Chromium	Composite	8 x per month	8 x per month	200.7
Lead	Composite	8 x per month	8 x per month	239.2
Mercury	Composite	8 x per month	8 x per month	245.1
Molybdenum	Composite	8 x per month	8 x per month	200.7
Nickel	Composite	8 x per month	8 x per month	200.7
Selenium	Composite	8 x per month	8 x per month	270.2
Silver	Composite	8 x per month	8 x per month	200.7
Thallium	Composite	8 x per month	8 x per month	279.2
Zinc	Composite	8 x per month	8 x per month	200.7
Cyanide	Grab	3 x per month	3 x per month	335.2
TPH	Grab	3 x per month	6-7 x per month	418.1
Pesticides/PCBs	Composite	3 x per month	3 x per month	608
Semi-volatiles	Composite	2 x per month	3 x per month	625
Volatiles	Grab	2 x per month	3 x per month	624
Whole Effluent Toxicity ³	Composite		1 x per month	WET Test Protocols

¹ Influent and effluent composite samples are 24-hour time composite samples.

² EPA Methods.

³ Effluent sample only.

Table H-4 [cont.]
POTW Monitoring Program

Parameter	Sample Type ¹	Sampling Frequency		Analytical Method ²
		Influent	Effluent	
Conventional				
pH	Grab	1 x per day	1 x per day	150.1
Settleable Solids	Grab	1 x per day	1 x per day	160.5
Biochemical Oxygen Demand	Composite	1 x per day	1 x per day	405.1
Carbonaceous BOD	Composite	1 x per day	1 x per day	405.1
Chemical Oxygen Demand	Composite	1 x per day	1 x per day	410.1
Total Suspended Solids	Composite	1 x per day	1 x per day	160.2
Total Coliform	Grab		3 x per day	9222 D ³
Fecal Coliform	Grab		3 x per day	9222 B ³
Oil and Grease	Grab	1 x per week	1 x per week	413.1
Chlorides	Composite	1 x per day		4500 B ³
Total Chlorine Residual	Grab		3 x per day	330.5
Nutrients⁴				
Total Kjeldahl Nitrogen	Composite	1 x per week	1 x per week	351.3
Ammonia	Composite	1 x per week	1 x per week	350.2
Nitrates	Composite	1 x per week	1 x per week	353.3
Nitrites	Composite	1 x per week	1 x per week	354.1
Orthophosphorus	Composite	1 x per week	1 x per week	365.2
Total Phosphorus	Composite	1 x per week	1 x per week	365.2

¹ Influent and effluent composite samples are 24-hour time composite samples.

² EPA Methods.

³ Standard Methods.

⁴ Sampling frequency is once a week at Deer Island.

Table H-5
CSO Monitoring Program

Parameter	Sample Type	Sampling Frequency	Analytical Method ¹
pH	Grab ²	See Footnote 2	150.1
Biochemical Oxygen Demand	Grab ²	See Footnote 2	405.1
Total Suspended Solids	Grab ²	See Footnote 2	160.2
Settleable Solids	Grab ²	See Footnote 2	160.5
Fecal Coliform	Grab ²	See Footnote 2	9222 B ³
Total Chlorine Residual	Grab ²	See Footnote 2	330.5

¹ EPA Methods.

² Grab samples are collected once within the first 2 hours of each discharge from the CSO treatment facility and every eight hours thereafter.

³ Standard Methods.

Appendix I

An Overview of the MWRA Sewerage System and Facilities

The MWRA is responsible for the collection, transport, pumping, treatment, and disposal of sewage in Boston and the greater Boston area. In addition to the Deer Island Treatment Plant, the MWRA operates another treatment plant, which serves the town of Clinton and the Lancaster Sewer District under special arrangements that originated when the Metropolitan District Commission (MDC) acquired land in Clinton for the Wachusett Reservoir. The Clinton Treatment Plant operates under a separate permit from the Boston NPDES permit and is not discussed in this report.

The MWRA serves 43 communities with a total population of about two million people, 5,500 businesses, and 1,400 industries. More than 5,400 miles of town- and city-owned local sewers connect at over 1,800 points to over 230 miles of MWRA interceptor sewers. Also included in the vast sewerage system are eleven pumping stations, five headworks, over 80 combined sewer relief overflows and six CSO treatment facilities. Table I-1 lists the MWRA treatment facilities and relevant information pertaining to each facility.

The Deer Island Treatment Plant in Winthrop serves the 43 communities in the metropolitan Boston sewerage system and is allowed to discharge under the Boston NPDES Permit. The sewerage system is divided into two major regions: the North and the South Systems. Table I-2 lists the sewerage service area population by community.

Table I-1 List of Treatment Facilities and Discharge Locations

Facility Name	Location	First year of Operation	Treatment Process	Design Flow (mgd)	Conduit Size At Facility: In	Conduit Size At Facility: Out	Outfall Number	Receiving Water
POTW								
Deer Island	Deer Island	1997	Primary Upgrade	1270		9'x 10'	MWR001	Boston
	Boston, MA	1998	Secondary			6'x 6.5'	MWR002	Harbor
						9' Dia	MWR004	
						9' Dia	MWR005	
CSO FACILITIES								
Cottage Farm	Memorial Dr. near Boston University Bridge, Cambridge	1971	Screening Settling Chlorination Detention	233	72" N. Charles Relief 42" S. Charles Relief 54" Brookline	96" Outfall	MWR201	Charles River
Prison Point	Near Museum of Science Bridge, Cambridge	1980	Screening Settling Chlorination Detention	385	10' Conduit	8' Conduit	MWR203	Inner Harbor
Somerville Marginal	McGrath Highway under Route I-93, Somerville	1973*	Screening Chlorination	245	7' x 7.5' Conduit 84" Conduit	6' x 8' Conduit	MWR205	Mystic River
Constitution Beach	Off Shore St. East Boston	1987	Screening Chlorination	20	36" Conduit	36" Conduit	BOS002	Boston Harbor
Fox Point	Freeport Street near Southeast Expressway, Dorchester	1989	Screening Chlorination	119	10' x 12' Conduit	10' x 12' Conduit	BOS089	Dorchester Bay
Commercial Point	Victory Road Dorchester	1991	Screening Chlorination	194	15' x 11' Conduit	15' x 11' Conduit	BOS090	Dorchester Bay

* Rehabilitated in 1988
MWR refers to MWRA
BOS refers to BWSC

**Table I-2
Sewerage Service Area Population By Community**

TOWN	COMMUNITY POPULATION ¹	SEWERED POPULATION ²	North System	South System	North System ³	South System ³
Arlington	43,656	43,612	x		43,612	
Ashland	12,940	8,152		x		8,152
Bedford	13,676	11,761	x		11,761	
Belmont	24,044	23,539	x		23,539	
Boston	558,394	557,836	x	x	420,274	137,562
Braintree	34,708	34,673		x		34,673
Brookline	54,137	53,704	x	x	23,420	30,284
Burlington	23,493	22,553	x		22,553	
Cambridge	93,707	93,613	x		93,613	
Canton	20,314	14,626		x		14,626
Chelsea	27,608	27,580	x		27,580	
Dedham	23,741	22,269		x		22,269
Everett	35,006	34,971	x		34,971	
Framingham	64,536	59,760		x		59,760
Hingham	6,235	5,206		x		5,206
Holbrook	11,092	7,210		x		7,210
Lexington	29,484	27,715	x		27,715	
Malden	52,749	52,696	x		52,696	
Medford	56,190	56,134	x		56,134	
Melrose	27,426	27,399	x		27,399	
Milton	25,794	23,988	x	x	2,240	21,748
Natick	31,310	25,831		x		25,831
Needham	27,828	25,323		x		25,323
Newton	80,238	78,312	x	x	42,860	35,452
Norwood	28,899	28,552		x		28,552
Quincy	85,532	85,446		x		85,446
Randolph	30,554	30,248		x		30,248
Reading	22,956	21,349	x		21,349	
Revere	41,761	41,719	x		41,719	
Somerville	74,356	74,282	x		74,282	
Stoneham	22,131	21,578	x		21,578	
Stoughton	27,481	17,313		x		17,313
Wakefield	24,756	23,692	x		23,692	
Walpole	22,251	14,018		x		14,018
Waltham	57,214	57,157	x		57,157	
Watertown	32,490	32,458	x		32,458	
Wellesley	26,809	25,254		x		25,254
Westwood	12,935	10,865		x		10,865
Weymouth	54,847	51,008		x		51,008
Wilmington	19,874	3,001	x		3,001	
Winchester	20,318	20,298	x		20,298	
Winthrop	17,305	17,288	x		17,288	
Woburn	36,628	35,712	x		35,712	
TOTALS	2,037,403	1,949,701			1,258,901	690,800

¹ Community population data are from Federal Census Bureau estimates of 1996 population.

² MWRA, preliminary sewer rates estimates for FY00.

³ Boston, Brookline, Milton, and Newton cross over between the North and South Systems. Population data for these communities estimated by MWRA's Infiltration/Inflow Program.

I.1 North System

The North System serves a population of about 1.3 million and is located to the north and west of Boston. It covers an area of about 168 square miles. Most of the North System is a separate system in which sanitary wastewater and storm water are carried in different conduits. However, portions of Boston, Cambridge, Somerville, and Chelsea still have combined sewers. About 20 percent of the North System service area is served by combined sewers. Community sewer lines tie into the MWRA system through interceptor lines that feed into remote headwork facilities.

Three remote headworks connect to the North Main Pump Station (NMPS) on Deer Island by two deep rock tunnels, the Boston Main Drainage Tunnel (BMDT) and the North Facilities Metropolitan Relief Tunnel (North Metro Relief). The seven-mile BMDT originates at the Ward Street Headworks, continues to the Columbus Park Headworks, and runs under Boston Harbor to the NMPS. The four-mile North Metro Relief Tunnel connects the Chelsea Creek Headworks to the NMPS. The two tunnels combined can handle approximately 800 mgd, matching the combined peak flow capacity of 788 mgd from the three remote headworks.

A fourth headworks facility, the Winthrop Terminal, is located on Deer Island and receives flows from the city of Winthrop and the East Boston (Caruso) Pump Station through the North Metro Trunk Sewer. Figure I-1 shows the North System schematics.

Figure I-1
North System Pump Stations, Headworks, CSOs and Tunnel Hydraulic Schematic

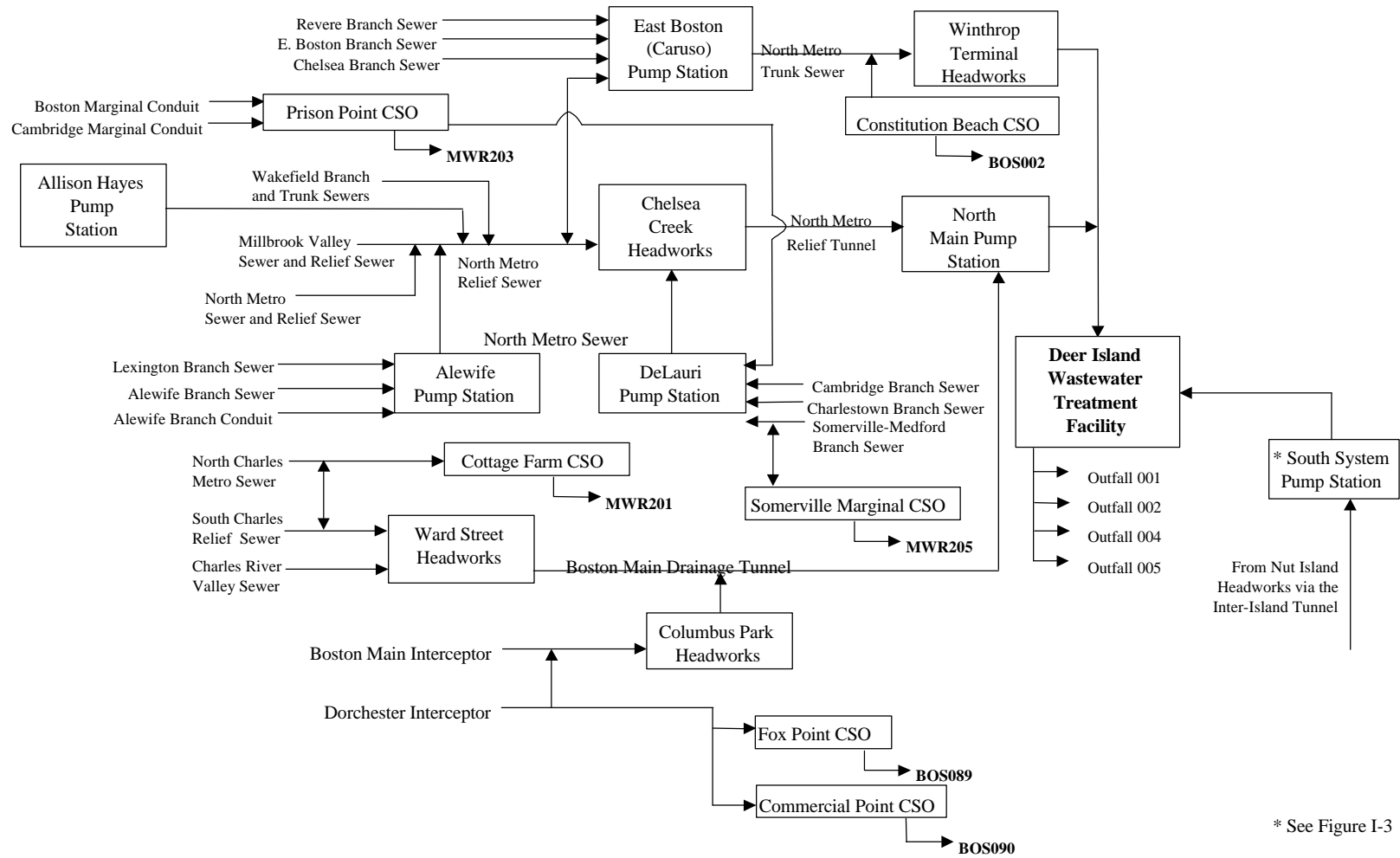

* See Figure I-3

1.1.a Pump Stations

The MWRA North System has four pump stations. Alewife Brook (64 mgd), Caruso (110 mgd), DeLauri (90 mgd), and Allison Hayes (11 mgd) pump stations convey wastewater to the headworks facilities. The four pump stations receive flow from interceptor lines as follows:

Alewife Brook Pump Station	Lexington Branch Sewer Alewife Branch Sewer Alewife Branch Conduit
Caruso (East Boston) Pump Station	Revere Branch Sewer East Boston Branch Sewer Chelsea Branch Sewer North Metro Relief Sewer *
DeLauri Pump Station	Cambridge Branch Sewer Charlestown Branch Sewer Medford-Somerville Branch Sewer Prison Point Pump Station Somerville Marginal CSO Overflow **
Allison Hayes Pump Station	Wakefield Branch Sewer

* When flow to the Chelsea Headworks is held back, wastewater is diverted to the Caruso Station.

** During low-intensity rainfall when line capacity is not exceeded, the combined wastewater is pumped back to the trunk sewers and ultimately to the DeLauri Station.

1.1.b Headworks

The Deer Island Treatment Plant receives North System flow from three remote headworks and the Winthrop Terminal Headworks. The three remote headworks, the Ward Street Headworks (256 mgd) located in Roxbury, the Columbus Park Headworks (182 mgd) located in South Boston, and the Chelsea Creek Headworks (350 mgd) located in Chelsea, have a combined pumping capacity of 788 mgd. The Winthrop Terminal Headworks (125 mgd) is located on Deer Island. The four North System headworks receive flows from interceptor lines or pump stations as follows:

Ward Street Headworks	South Charles Relief Sewer Charles River Valley Sewer North Charles Metro Sewer * Cottage Farm CSO *
Columbus Park Headworks	Boston Main Interceptor Dorchester Interceptor
Chelsea Creek Headworks	Alewife Pump Station North Metro Relief Sewer DeLauri Pump Station Caruso Pump Station Overflow
Winthrop Terminal Headworks	Winthrop Sewer Caruso Pump Station **

* During low-intensity rainfall when line or holding capacity are not exceeded, the combined wastewater is pumped back to the trunk sewers and ultimately to the Ward Street Headworks.

** Overflow from the Caruso Pump Station.

1.1.c Combined Sewer Overflow Facilities

The conditions for discharge of effluent from three CSO chlorination facilities are also included in MWRA's Boston NPDES permit. These three CSO chlorination facilities, Cottage Farm in Cambridge, Prison Point in Cambridge, and Somerville Marginal in Somerville, discharge to the Charles River, the Inner Harbor, and the Mystic River respectively. Three other CSO chlorination facilities, Constitution Beach in East Boston, Fox Point in Dorchester, and Commercial Point in Dorchester, are owned and operated by the MWRA. These facilities, which discharge to Boston Water and Sewer Commission (BWSC) lines, are included in the BWSC NPDES permit. The new MWRA NPDES permit will include all six CSO facilities.

Discharge of combined wastewater from a CSO treatment facility to a receiving body of water is defined in this report as a CSO activation. Discharge of combined wastewater to a CSO outfall pipe is defined as a CSO overflow. CSO overflows will not be discussed in this report. In general, CSO activations occur as a result of heavy rain, snowmelt, or choking at the headworks.

Choking is the process by which the headworks restricts the flow to Deer Island. During wet weather, when the wastewater volume exceeds the hydraulic capacity of the treatment plant, the headworks “chokes” the flow and holds the wastewater in the lines. As a result, the combined wastewater backs up into the system, forcing the combined wastewater to overflow to CSO treatment facilities and CSO outfall pipes, resulting in potential CSO activations and overflow. In addition to choking in response to hydraulic demand on the system, the headworks may choke so that emergency repairs, system testing, or maintenance work can be performed at the treatment plant. Choking at Ward Street and Columbus Park Headworks influences Cottage Farm activations. Choking at the Columbus Park Headworks can influence activations at Fox Point and Commercial Point CSOs. Backups at the DeLauri Pumping Station brought about by choking at the Chelsea Headworks can activate the Somerville Marginal CSO.

At the CSO facilities, the combined wastewater is chlorinated prior to discharge. Of the six CSO facilities, only Cottage Farm and Prison Point have tank storage capacity. This allows the chlorinated wastewater to be held at these facilities prior to discharge. When the CSO facility’s storage capacity is exceeded, treated wastewater overflows and is discharged to the river. The four other CSO facilities are gravity CSO facilities, which means that combined wastewater arrives and leaves the CSO facility by gravity. This type of facility provides disinfection and allows the chlorinated combined wastewater to overflow to the receiving water as quickly as the wastewater arrives at the facility. Figure I-2 is a schematic of a typical gravity CSO treatment facility.

Figure I-2
Combined Sewer Overflow Treatment Facility

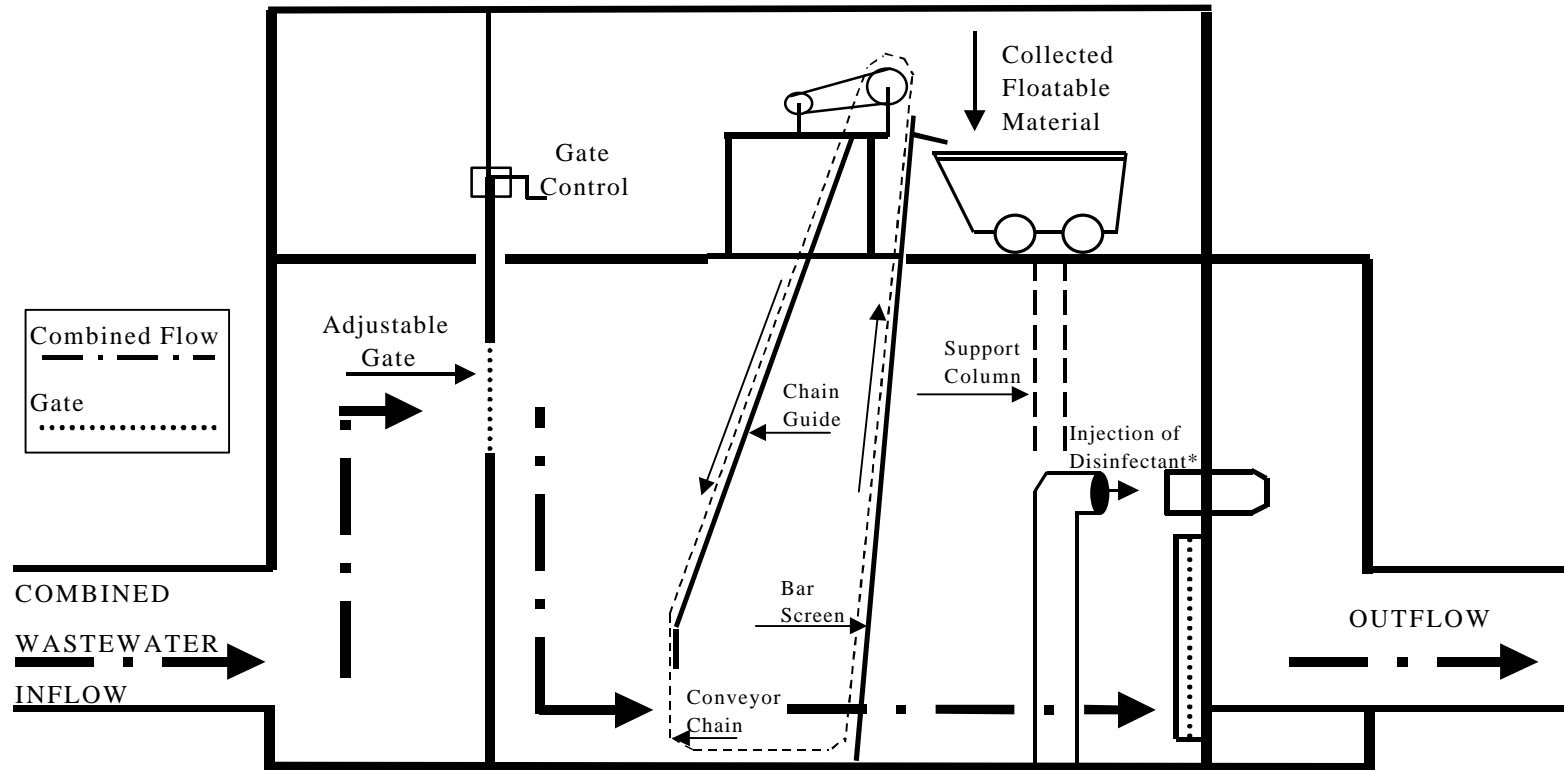

* At Somerville Marginal, injection occurs at the influent gate

The six CSO facilities provide treatment for approximately 50% of the CSO volume while the other half overflows in any of the 85 permitted CSO overflow structures of the sewerage system without the benefit of any type of treatment. Of the 85 permitted CSO overflow structures, 53 are located in Boston, 15 in Cambridge, 5 in Chelsea, and 12 in Somerville. These outfalls discharge into Boston Harbor, the Alewife Brook, the Mystic River, the Charles River, and the Neponset River.

Prison Point Combined Sewer Overflow Facility

Prison Point is both a dry weather and storm water pumping station. The dry weather phase is a five-mgd capacity sewer pumping station that receives flow from the Boston Marginal Conduit and the Cambridge Marginal Conduit. Prison Point feeds into the DeLauri Pumping Station.

The storm water phase has a maximum pumping capacity of 385 mgd. Treatment includes screening, disinfection, and detention. During wet weather, if the dry pumping capacity is exceeded, the combined flow is screened, chlorinated, and held in detention basins. Once the basins fill, treated flow is discharged downstream below the new Charles River Dam at outfall MWR203. Combined wastewater volume that is held back, up to 1.2 mgd, is pumped back to the DeLauri Station. This facility came on-line in 1980.

Cottage Farm Combined Sewer Overflow Facility

During dry weather conditions, wastewater arrives at the Ward Street Headworks where it is pumped to the Deer Island Plant. Under storm conditions, wastewater backs up into sewer lines and into the Cottage Farm CSO facility. Cottage Farm detains wastewater up to a volume of 1.3 MG. Any excess flow is screened, settled, chlorinated, and discharged to the Charles River through outfall MWR201. Combined wastewater that is held back is pumped back to the Ward Street Headworks. This facility, on-line since 1971, has a design pumping capacity of 233 mgd.

Somerville Marginal Combined Sewer Overflow Facility

Somerville Marginal CSO is an unmanned gravity facility with a design capacity of 245 mgd. It receives wet weather flow from the northeast portion of Somerville and part of Medford. Normally, dry weather flow from these areas arrives at the DeLauri Station via the Somerville-Medford trunk sewers. During wet weather, combined sewer flow backs up to the Somerville CSO facility. Unlike Cottage Farm or Prison Point, this facility does not provide any detention capacity during storm conditions. Treatment consists of screening and chlorination. Effluent is discharged to the lower Mystic River basin at outfall number MWR205. During low-intensity rainfall when line capacity is not exceeded, the combined wastewater is pumped back from a wet well to the DeLauri Station. This facility came on-line in 1973 and was upgraded in 1988.

Constitution Beach Combined Sewer Overflow Facility

Constitution Beach is an unmanned gravity facility with a design capacity of 20 mgd. It receives flows from the North Metro Trunk sewer. Treatment consists of screening and disinfection. Effluent is discharged to a BWSC line that ultimately discharges to Boston Harbor through outfall number BOS002. This outfall is included in the BWSC permit. Since the issuance of that permit, full ownership of Constitution Beach CSO Facility has been transferred to MWRA. This facility came on-line in 1987.

Fox Point Combined Sewer Overflow Facility

Fox Point is an unmanned gravity facility with a design capacity of 119 mgd. It receives wet weather flows from the Dorchester Interceptor sewer line. Operation of this facility parallels that of the Constitution Beach CSO; treatment includes screening and disinfection. Effluent is discharged to a BWSC sewer line that discharges to Dorchester Bay through outfall number BOS089. This outfall is included in the BWSC permit. This facility came on-line in 1989.

Commercial Point Combined Sewer Overflow Facility

Commercial Point is an unmanned gravity CSO with a design capacity of 194 mgd. This facility also receives wet weather backups from the Dorchester Interceptor. Treatment includes screening and

disinfection. Effluent is discharged to a BWSC line that ultimately discharges to Dorchester Bay through outfall number BOS090. This outfall is included in the BWSC permit. This facility came on-line in 1991.

I.2 South System

The South System serves a population of about 700,000 people and is located to the south and southwest of Boston. The South System covers an area of approximately 237 square miles. Figure I-3 illustrates the South System schematics. Community sewer lines tie into the South System through MWRA interceptor lines. The Framingham Extension Sewer, Wellesley Extension Sewer, Upper Neponset Valley Sewer, Wellesley Extension Relief Sewer, Neponset Valley Sewer, Walpole Extension Sewer, Stoughton Extension Sewer, Braintree-Randolph Trunk Sewer, and several other branch sewers discharge to the South System High Level Sewer. The High Level Sewer has a capacity of 360 mgd. Pump stations move the wastewater through the High Level Sewer to the Nut Island Headworks for preliminary treatment. The South System flows are then conveyed to the South System Pump Station at Deer Island through the 4.7-mile Inter-Island Tunnel for treatment at the Deer Island Treatment Plant.

I.2.a Pump Stations

Seven MWRA pump stations move wastewater from low-lying areas to the High Level Sewer: Hingham Pump Station (16.5 mgd), Braintree-Weymouth Pump Station (60 mgd), Squantum Pump Station (12 mgd), Houghs Neck Lift Station (2.8 mgd), Neponset Pump Station (90 mgd), Framingham Pump Station (48 mgd) and Quincy Pump Station (52 mgd). The high level sewer conveys wastewater to the Nut Island Headworks for preliminary treatment .

The seven pumping stations receive flow from interceptor or community lines as follows:

Hingham Pump Station	Weymouth-Hingham Sewer Lines
Braintree-Weymouth Pump Station	Braintree-Randolph Trunk Sewer Braintree-Weymouth Extension Sewer Holbrook Extension Sewer Hingham Pumping Station
Squantum Pump Station	Squantum Sewers
Houghs Neck Lift Station	Houghs Neck Sewer
Neponset Pump Station	Neponset Valley Sewer

Framingham Pump Station

Framingham Sewers

Quincy Pump Station

Quincy and Upstream Sewers

Wastewater collected from the South System communities is conveyed to Deer Island via the 4.7-mile Inter-Island Tunnel. The South System Pump Station, located on Deer Island, delivers the South System flow to the Deer Island Treatment Plant. This South System wastewater has already been screened and degrittied by the Nut Island Headworks.

Two force mains deliver the South System flow to one of two locations. The South System flow is normally discharged to the effluent channel of the Grit Facility, where it is combined with the North System and recycle flows, then split between Primary Clarifier Batteries A through D. The alternate discharge location is directly to the Primary Clarifier Battery D influent channel, which allows the South System flow to be isolated.

1.2.b Headworks

The Deer Island Treatment Plant receives South System flow from the new Nut Island Headworks. The Nut Island Headworks went on-line on July 7, 1998. It is located in Quincy and has a pumping capacity of 360 mgd.

Figure I-3
South System Hydraulic Schematic

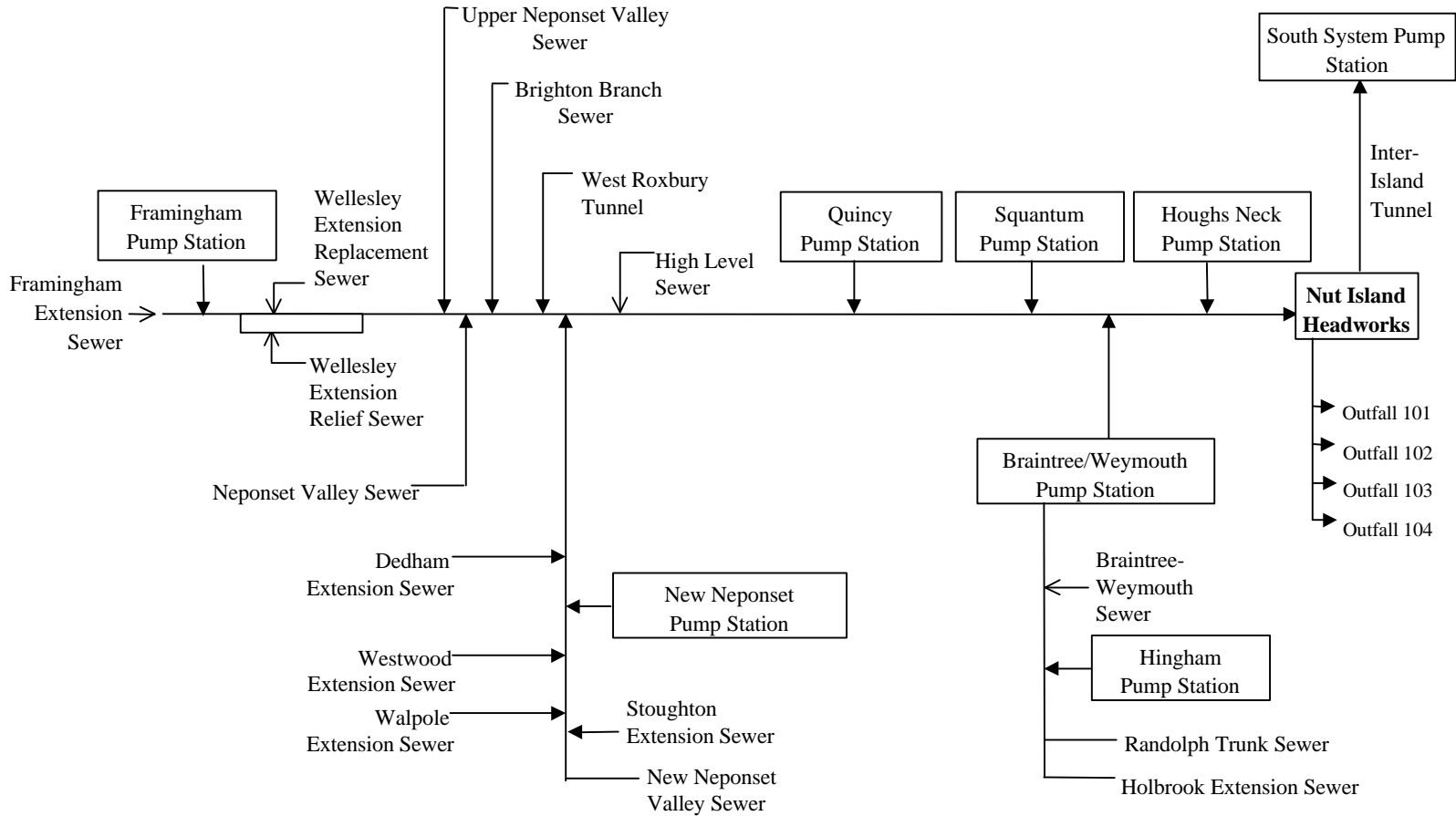

I.3 Deer Island Treatment Plant

Until FY99, wastewater flows from the North System were treated at the Deer Island Treatment Plant and flows from the South System were treated at the Nut Island Treatment Plant. In July 1998, the Nut Island Treatment Plant was decommissioned and all flows were treated at Deer Island.

Four lines convey sewage to the Deer Island Treatment Plant. North System wastewater is delivered to the plant via the Boston Main Drainage Tunnel (from the Ward Street and Columbus Park Headworks), the North Metropolitan Relief Tunnel (from the Chelsea Creek Headworks), and the North Metropolitan Trunk Sewer. South System wastewater is transferred to the plant from the Nut Island Headworks via the 4.7-mile Inter-Island Tunnel.

The Deer Island Treatment Plant receives wastewater at the North Main Pump Station (NMPS), the Winthrop Terminal, and the new South System Pump Station (SSPS). The North Metro Relief Tunnel and the Boston Main Drainage Tunnel connect to the NMPS, which consists of ten pumps, each rated at 110 mgd, for a total pumping capacity of 1,100 mgd. The North Metro Trunk Sewer connects to the Winthrop Terminal. The Inter-Island Tunnel connects to the SSPS, which consists of eight pumps, each rated at 66.7 mgd.

Grit removal and screening (preliminary treatment) is provided at the remote headworks. Flow from the South System receives preliminary treatment at the Nut Island Headworks. Flow from the city of Winthrop is degrittied at the Winthrop Terminal. Grit chambers and screens remove heavy particles and debris from the wastewater. Grit and screenings are landfilled off-site.

The new primary treatment plant came on-line on January 21, 1995. Secondary treatment was initiated at Deer Island in July 1997. By the end of FY98, there were two batteries of secondary treatment on-line. A third battery will be added sometime in FY00. Figure I-4 presents the new Deer Island plant process flow diagram.

Figure 1-1

Deer Island Treatment Plant Process

Population Served: 2.08 Million People. Average Design Flow: 480 MGD. Peak Design Flow: 1270 MGD
 Current Operation - December, 1999

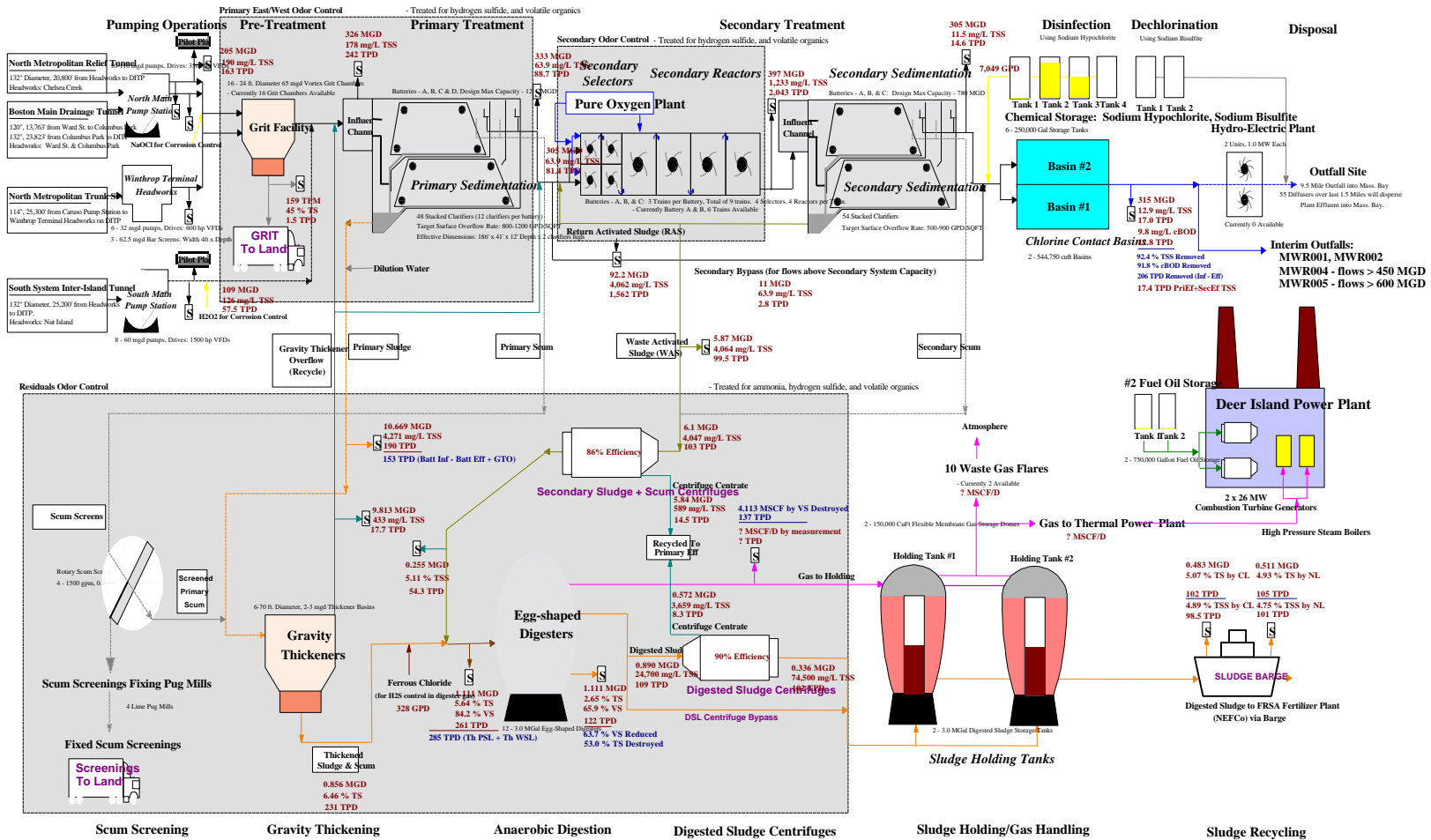

☒ - Sample Withdrawal Point

Wastewater from the North System flows through the grit chambers for additional grit removal. It then flows to the primary settling tanks where floatables (consisting mainly of oil, grease, and plastics) rise to the surface while the sludge (consisting of heavy solid particles) settles to the bottom. A portion of the primary effluent (the allowable capacity for secondary treatment) is sent to secondary treatment, while the remaining portion (from high flow conditions due to rainfall) is sent directly to the disinfection basins to be treated with sodium hypochlorite. Effluent from secondary treatment is then sent to the disinfection basins, and is combined with the primary effluent.

The scum (floatables) is skimmed off the top of the primary and secondary settling tanks while the sludge (settled solids) is scraped from the bottom of the tanks. Scum is pumped to the scum concentrator while the sludge is pumped to the sludge thickeners. After the scum and sludge are concentrated and thickened, they are conveyed to the anaerobic digesters for further treatment. The digested sludge/scum is barged to the Fore River Pelletizing Plant, where it is converted into fertilizer.

1.3.a Deer Island Outfalls

Effluent is channeled through a common conduit to four potential outfall pipes, 001, 002, 004, and 005. Figure I-5 illustrates the Deer Island outfall schematics while Table I-3 presents the specifics of each outfall. Outfalls 001, 002 and 004 connect to Chamber C while outfall 005 connects to Chamber A. A sluice gate in Chamber A controls discharge from outfall 005. Likewise, a sluice gate in Chamber C isolates discharge from outfall 004. Of the four permitted outfalls, only outfalls 001 and 002 are used regularly. Outfall 004 is used only during high flow conditions, while relief outfall 005, although not generally used, can be activated during extremely high flows or emergency situations. Outfall 003 is permanently blocked and out of service.

The amount of wastewater that can be pumped to the plant is not only limited by sewer line capacity, treatment plant capacity, and pumping capacity, but also by the outfall pipe capacity. The approximate amounts of treatment plant effluent that can be discharged through the outfalls are as follows:

Outfalls 001 & 002

High tide 400 mgd
 Low tide 735 mgd

Outfalls 001 & 002 & 004
 High tide 635 mgd
 Low tide 900 mgd

Outfalls 001 & 002 & 004 & 005
 High tide 900 mgd
 Low tide 1,270 mgd

Table I-3 Deer Island Outfall Characteristics				
	Outfall Number			
	No. 001	No. 002	No. 004	No. 005
Length (ft.)	2260	2565	500	135
Discharge Elevation (ft.)	54.7	54.7	97.8	98
Number of Open Ports	14	47	1	1
Port Diameter (ft.)	1.67	1.69	9	9
Chamber Invert Elevation (ft.)	98.1	98.1	98.1	103.2
Chamber Overflow Elevation (ft.)	120	120	120	125
Pipe Size (in.) and Pipe Material	16 x 12 concrete to 12 x 10 concrete to 10 (diameter) reinforced concrete (RC)	6 x 6.25 to 9 (diameter) brick with concrete casing	9 (diameter) reinforced concrete (RC)	9 (diameter) reinforced concrete (RC)
Year Built	1896	1959	1959	1959

1.3.b Nut Island Outfalls

The former Nut Island Treatment Plant discharged treated wastewater through four outfalls. Although the Nut Island Treatment Plant no longer exists, outfalls 101, 102 and 103 remain operational in case of emergency. These outfalls discharge to Boston Harbor; the spillway discharges to Hingham Bay.

Figure I-5
Deer Island Outfall System Schematic

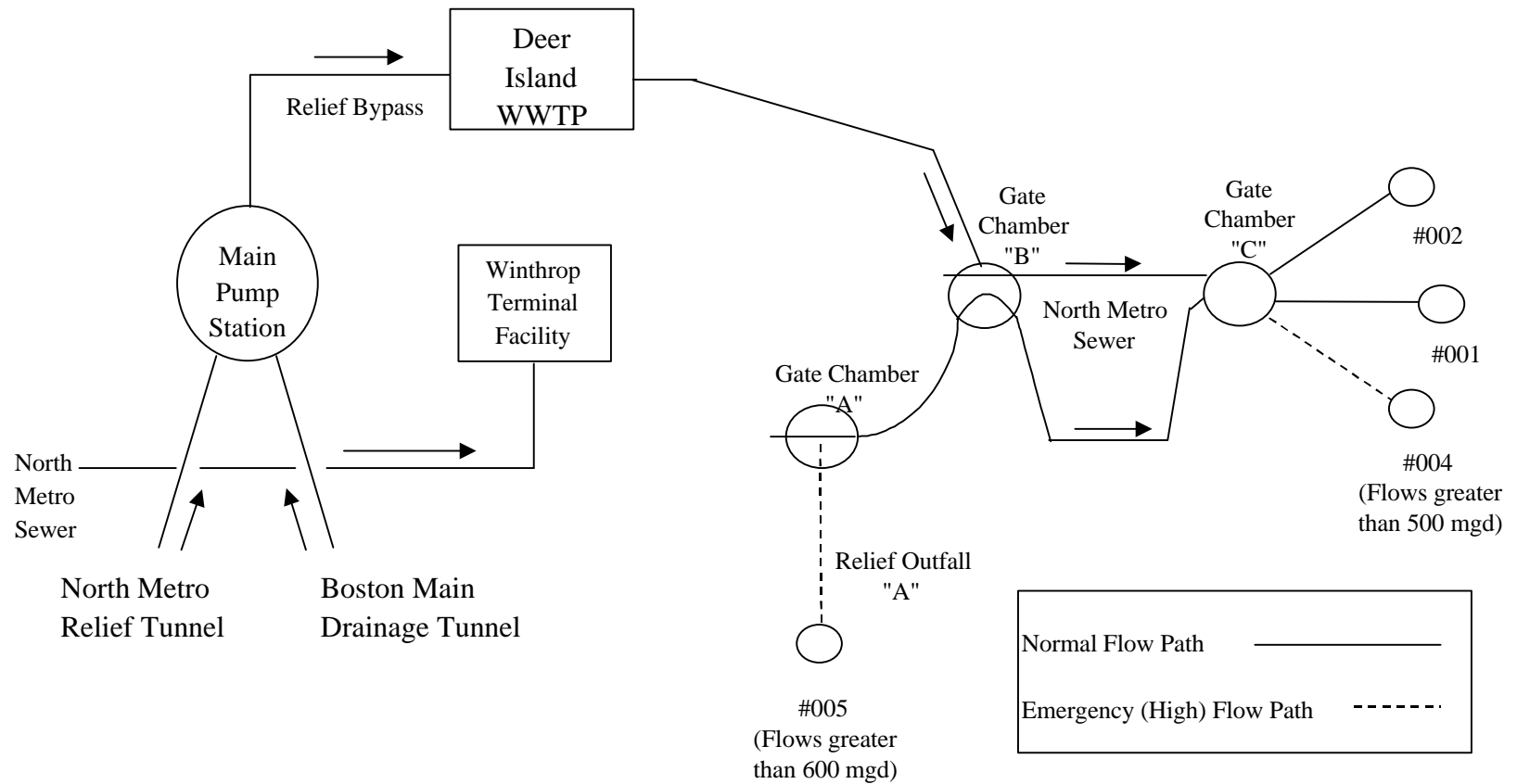

1.3.c Outfall Tunnel

Once the new outfall tunnel goes on-line, there will no longer be discharge of treated wastewater from the Deer Island Treatment Plant into Boston Harbor. All effluent flows will be sent via the new 9.5-mile outfall tunnel to Massachusetts Bay.

I.4 Sanitary Sewer Overflows

An issue of concern in both the North System and the South System is the occurrence of Sanitary Sewer Overflows (SSOs). These occur during extreme rainfall events, when the combined wastewater and storm water flows exceed the capacity of the pipes and cause certain areas to become inundated. As a matter of course, whenever there is a high amount of rainfall, a crew from the Transport Department investigates a number of critical areas to visually monitor overflows. While some of these critical areas are the MWRA's responsibility, most of them are the responsibility of the local communities. A list of these areas and who is responsible for them is included in Table I-4. Not all of these areas are checked during every rainfall, and some are monitored by the MWRA only during extreme storm events.

Table I-4 MWRA Sewer System Overflow Locations

<u>Number</u>	<u>Owner</u>	<u>Location and Description</u>
1	MWRA ^{1,3}	Section 107 (Overflow Relief Point) Medford, On Median Strip of On Ramp to Rt. 16
2	MWRA ¹	Section C (Overflow Relief Point) Medford, Auburn St. at Rt. 16
3	MWRA ¹	Section 91B (Siphon) Medford, Lakeview Ter. At Mystic Valley Pkwy
4	MWRA ^{1,3}	Section 91B (Manhole) Medford, Lakeview Ter.
5	MWRA ^{2,3}	Section 126 (Siphon) Braintree, Easement between Commercial St. & Quincy Ave.
6	MWRA ^{2,3}	Section 126 (Manhole) Braintree, Idlewell Blvd.
7	MWRA ²	Section 128 (Siphon) Braintree, Pearl St.
8	MWRA ²	Norwood, Manhole
9	MWRA ²	Weymouth, Manhole, Regina Rd.
10	Newton	Manhole, 100 Peregrine Rd.
11A	Roslindale	Manhole, Florence St. Sycamore St.
11B	Roslindale	Manhole, Sammett Ave. Mt. Hope Rd. Holly St.
11C	Roslindale	Manhole, Archdale St.
12	Everett	Manhole, Preston St.
13	Malden	Manhole, Taylor St.
14	Medford	Manhole, Roosevelt St.
15	Medford	Manhole, Mystic Ave.
16	Arlington	Manhole, Kimball Rd.
17	Arlington	Manhole, Summer St.
18	Quincy	Manhole, 40 Willard St.
19	W. Roxbury	Manhole, 307 V.F.W. Parkway
20	Hyde Park	Manhole, Clark Ave. American Legion Hwy.
21	Arlington	Manhole, 22 Grove St.
22	Weymouth	Manhole, 159 Spring Way
23	Hyde Park	Manhole, 46 Collins St.
24	Hyde Park	Manhole, 45 Sierra St.
25	Braintree	Manhole, 16 Allen St.
26	Newton	Manhole, 183 Old Farm Rd.

Table I-4 MWRA Sewer System Overflow Locations (continued)

<u>Number</u>	<u>Owner</u>	<u>Location and Description</u>
27	Arlington	Section 80 (Overflow Relief Point) Behind Brattle Court Pumping Station
28	Arlington	Section 80 (Overflow Relief Point) Hobbs Court Plug- Temporary
29	Medford	Section 43.5 (Overflow Relief Point) Boston Ave. At Rt. 16
30	Cambridge	Section B (Overflow Relief Point) Alewife Brook at T-Station
31	Malden	Section 19 (Overflow Relief Point) Off Commercial Street at Malden River
32	Winchester	Section 113 (Siphon) Wedgemere Siphon
33	Natick	Section 132 (Siphon) Eliot St.
34	Norwood	Section 117 (Siphon and Manhole) Wooded Area at Neponset River
35	Canton	Section 121 (Manhole) Wooded Area at Steep Hill Brook Neponset River
36	Norwood	Manhole, New Walpole Extension Sewer Behind Overlook Dr.

¹ North System

² South System

³ Active during severe storms in conjunction with high ground water and limited capacity

Appendix J

Instrument Detection Limits, Method Detection Limits, and Quantitation Limits: A Brief Description

An understanding of the detection limits of analysis is essential to reviewing the data from chemical analyses. There are three different types of detection limits that are most often encountered:

- **Instrument Detection Limits**
- **Method Detection Limits**
- **Quantitation Limits**, also known as **Reporting Limits**.

Instrument detection limits (IDL) reflect the capability of the instrument. This will be the lowest of the three detection limits. The IDL will not take into account the losses of the pollutant associated with the matrix (soil or wastewater) and extraction procedure. This discrepancy is known as matrix interference.

Method detection limits (MDL) are the smallest amount of a substance that can be detected above background noise using a particular method. The MDL is statistically determined by running a series of analyses using various low concentrations of a pollutant. Using a Student's "T" test, the smallest concentration that has a 99% probability of being detected above the background is designated the MDL for that pollutant. The EPA, using several private laboratories, has determined what the MDLs are for most priority pollutants using their approved methods. These are published in the 40 CFR and some are listed in Table K-1 of Appendix K of this report.

In general, if a plot is made of pollutant concentration versus instrument response, it will generate a linear relationship. As the pollutant concentration approaches zero, the linearity of the relationship is lost. At the point where the linearity is lost is the **Quantitation Limit (QL)** or sometimes the **Reporting Limit**. In other words, the smallest concentration where the linear relationship holds is the smallest concentration that can be quantified. Generally, the QL is about five times the MDL.

Quantitative limits are relevant to GC/MS analyses, that is, methods 608 (for pesticides), 624 (for volatile organics), and 625 (for semi-volatile organics). Specific limits are highly matrix-dependent.

The EPA has developed **Contract Required Quantitation Limits (CRQL)**, which serve as a guideline for selecting contract laboratories to perform analyses. Some CRQLs are listed in Table K-1 of this report.

In short, the IDL is the lowest concentration that a particular instrument can detect. The MDL is the lowest concentration that can be detected using a particular method. The QL is the smallest concentration that can be confidently considered to be accurate.

Reported concentrations that are between the MDL and the QL indicate that a pollutant is present, but at a concentration too low to be accurately quantified. For example, using EPA method 624, chloroform has an MDL of 1.6 µg/L and a QL of 10 µg/L. If the concentration from an analysis is reported as 5 µg/L then it can be inferred that although the actual chloroform concentration in the wastewater is uncertain, 5 µg/L is a best guess. The EPA requires that these intermediate values be flagged with a “J” on any reports submitted to them. Therefore, these are sometimes simply called “J-values.”

For non-detects in analyses of metals, cyanide, petroleum hydrocarbons, etc., it is customary for “less than the MDL” to be listed as a result. For a non-detect in the 608, 624, and 625 analyses, “less than the QL” is typically listed.

Often it becomes necessary to estimate a concentration for below detection limit values, specifically when calculating the average yearly concentration of a pollutant. A well established method is to assume the actual concentration of a non-detected pollutant is simply one half of the MDL. While no scientific theory supports this assumption, it is more reasonable than assuming that the concentration is zero, or the MDL itself. It is also accepted by the EPA and DEP as a standard practice that can be applied to any series of tests.

This technique is utilized in this report. For the organic compounds – methods 608, 624, and 625 – one tenth of the QL, or half the MDL, was assumed for all non-detects (i.e. values below QL). For all metals, cyanide, petroleum hydrocarbons, etc., half the MDL was assumed for all non-detects (i.e. values below MDL).

In Appendix K, Table K-1 is a list of the parameters regularly tested for in MWRA effluent. The required EPA method is referenced by its number and the recommended EPA detection limit is provided. The CRQL is also provided when applicable. These limits are compared to the detection levels normally attained by the contract laboratory analyzing MWRA effluent.

Appendix K

Priority Pollutants List and Other Parameters

Table K-1 List of Parameters Tested

Table K-2 EPA List of 126 Priority Pollutants

Table K-3 NPDES Permit Testing Requirements, 40 CFR 122, Appendix D,

Tables I and II

Table K-1 List of Parameters Tested

(Influent and Effluent)*

	EPA Method Number	EPA MDL	CRQL	Contract Lab MDL	Contract Lab QL
METALS					
Antimony	204.2	3.0	NA	5.0	NA
Arsenic	206.2	1.0	NA	2.0	NA
Beryllium	200.7	0.3	NA	1.0	NA
Cadmium	213.2	0.1	NA	1.0	NA
Chromium	218.2	1.0	NA	5.0	NA
Copper	200.7	6.0	NA	4.0	NA
Lead	239.2	1.0	NA	1.5	NA
Mercury	245.1	0.2	NA	0.2	NA
Nickel	200.7	15.0	NA	12.0	NA
Selenium	270.2	2.0	NA	2.0	NA
Thallium	279.2	1.0	NA	2.0	NA
Zinc	200.7	2.0	NA	10.0	NA
Boron	200.7	5.0	NA	30.0	NA
Molybdenum	246.2	1.0	NA	8.0	NA
Silver	272.2	0.2	NA	3.0	NA
OTHER INORGANIC CHEMICALS **					
Cyanide	335.2	20.0	NA	10.0	NA
Hexavalent Chromium	307 B	10.0	NA	5.0	NA
Oil & Grease (mg/L)	413.1	5.0	NA	5.0	NA
Petroleum Hydrocarbons (mg/L)		1.0	NA	1.0	NA
Surfactants (mg/L)		25.0	NA	25.0	NA
PESTICIDES					
	608			NA	
alpha-BHC		0.003	0.05		0.05
beta-BHC		0.006	0.05		0.05
delta-BHC		0.009	0.05		0.05
gamma-BHC (Lindane)		0.004	0.05		0.05
Heptachlor		0.003	0.05		0.05
Aldrin		0.004	0.05		0.05
Heptachlor epoxide		0.083	0.05		0.05
Endosulfan I		0.014	0.05		0.05
Endrin aldehyde		0.023	0.10		0.10
Dieldrin		0.002	0.10		0.10
4,4'-DDE		0.004	0.10		0.10
Endrin		0.006	0.10		0.10
Endosulfan II		0.004	0.10		0.10
4,4'-DDD		0.011	0.10		0.10
Endosulfan sulfate		0.066	0.10		0.10
4,4'-DDT		0.012	0.10		0.10
Methoxychlor			0.50		0.50

Table K-1 List of Parameters Tested [cont.]

(Influent and Effluent)*

	EPA Method Number	EPA MDL	CRQL	Contract Lab MDL	Contract Lab QL
Toxaphene		0.240	0.50		5.00
Chlordane		0.014	1.00		1.00
PCBs					
Aroclor-1016		ND	2.00		2.00
Aroclor-1221		ND	1.00		1.00
Aroclor-1232		ND	1.00		1.00
Aroclor-1242		0.065	1.00		1.00
Aroclor-1248		ND	1.00		1.00
Aroclor-1254		ND	1.00		1.00
Aroclor-1260		ND	0.05		0.20
VOLATILE ORGANICS					
	624				
Chloromethane		ND	10		10
Bromomethane		ND	10		10
Vinyl chloride		ND	10		10
Chloroethane		ND	10		10
Methylene chloride		2.8	10		10
Acetone			10		10
Carbon disulfide			10		10
1,1-dichloroethylene		2.8	10		10
1,1-dichloroethane		4.7	10		10
1,2-dichloroethylene		1.6	10		10
Chloroform		1.6	10		10
Methylethyl ketone (2-butanone)			10		10
1,2-dichloroethane		2.8	10		10
1,1,1-trichloroethane		3.8	10		10
Carbon tetrachloride		2.8	10		10
Vinyl acetate			10		10
Bromodichloromethane		2.2	10		10
1,2-dichloropropane		6.0			
Cis-1,3-dichloropropene		5.0	10		10
Trichloroethylene		1.9	10		10
Chlorodibromomethane		3.1	10		10
1,1,2-trichloroethane		5.0	10		10
Benzene		4.4	10		10
Trans-1,3-dichloropropene		ND	10		10
Bromoform		4.7	10		10
4-methyl-2-pentanone			10		10
2-hexanone			10		10
Tetrachloroethylene		4.1	10		10
1,1,2,2-tetrachloroethane		6.9	10		10
Toluene		6.0	10		10

Table K-1 List of Parameters Tested [cont.]

(Influent and Effluent)*

	EPA Method Number	EPA MDL	CRQL	Contract Lab MDL	Contract Lab QL
Chlorobenzene		6.0	10		10
Ethylbenzene		7.2	10		10
Styrene			10		10
Xylene (Total)			10		10
2-chloroethylvinylether			10		10
Trichlorofluoromethane			10		10
Acrolein			10		10
Acrylonitrile			10		10
SEMI-VOLATILES	625				
Phenol		1.5	10		10
Bis (2-chloroethyl) ether		5.7	10		10
2-chlorophenol		3.3	10		10
m-dichlorobenzene		1.9	10		10
p-dichlorobenzene		1.9	10		10
o-dichlorobenzene		1.9	10		10
o-cresol			10		10
2,2'-oxybis (1-chloropropane)		5.7	10		10
p-cresol			10		10
N-nitroso-di-n-propylamine		ND	10		10
Hexachloroethane		1.6	10		10
Nitrobenzene		1.9	10		10
Isophrone		2.2	10		10
o-nitrophenol		3.6	10		10
2,4-dimethylphenol		2.7	10		10
Bis (2-chloroethoxy)methane		5.3	10		10
2,4-dichlorophenol		2.7	10		25
1,2,4-trichlorobenzene		1.9	10		10
Naphthalene		1.6	10		10
p-chloroaniline			10		10
Hexachlorobutadiene			10		10
p-chloro-m-cresol			10		10
2-methylnaphthalene			10		10
Hexachlorocyclopentadiene		ND	10		10
2,4,6-trichlorophenol		2.7	10		10
2,4,5-trichlorophenol			25		25
2-chloronaphthalene		1.9	10		10
o-nitroaniline			25		25
Dimethyl phthalate		1.6	10		10
Acenaphthylene		3.5	10		10
2,6-dinitrotoluene		1.9	10		10
m-nitroaniline			25		25

Table K-1 List of Parameters Tested [cont.]

(Influent and Effluent)*

	EPA Method Number	EPA MDL	CRQL	Contract Lab MDL	Contract Lab QL
Acenaphthene		1.9	10		10
2,4-dinitrophenol		42.0	25		25
p-nitrophenol		3.6	25		25
Dibenzofuran			10		10
2,4-dinitrotoluene		5.7	10		10
Diethyl phthalate		1.9	10		10
4-chlorophenyl phenyl ether		4.2	10		10
Fluorene		1.9	10		10
p-nitroaniline			25		25
4,6-dinitro-o-cresol			10		10
N-nitrosodiphenylamine		1.9	10		10
4-bromophenyl phenyl ether		1.9	10		10
Hexachlorobenzene		1.9	10		10
Pentachlorophenol		3.6	25		10
Phenanthrene		5.4	10		10
Anthracene		1.9	10		10
Di-n-butyl phthalate		2.5	10		10
Fluoranthene		2.2	10		10
Pyrene		1.9	10		10
Butyl benzyl phthalate		2.5	10		10
3,3'-dichlorobenzidine		16.5	10		10
Benzo(a)anthracene		7.8	10		10
Chrysene		2.5	10		10
Bis (2-ethylhexyl) phthalate		2.5	10		10
Di-n-octyl phthalate		2.5	10		10
Benzo(b)fluoranthene		4.8	10		10
Benzo(k)fluoranthene		2.5	10		10
Benzo(a)pyrene		2.5	10		10
Indeno(1,2,3-cd)pyrene		3.7	10		10
Dibenzo(a,h)anthracene		2.5	10		10
Benzo(ghi)perylene		4.1	10		10
Benzoic acid			10		10
Benzyl alcohol		ND	10		10
Benzidene		44	10		10
1,2-diphenylhydrazine			10		10
N-nitrosodimethylamine		ND	10		10

* Pollutants analyzed in addition to influent and effluent analyses of conventional pollutants listed in Appendix A, Table A-1. All units expressed in $\mu\text{g/L}$ unless otherwise noted.

** Units expressed in mg/L.

ND - Not determined by EPA

NA - Not applicable

Table K-2 EPA List of 126 Priority Pollutants

Chlorinated Benzenes

Chlorobenzene
1,2-dichlorobenzene
1,3-dichlorobenzene
1,4-dichlorobenzene
1,2,4-trichlorobenzene
Hexachlorobenzene

Chlorinated Ethanes

Chloroethane
1,1-dichloroethane
1,2-dichloroethane
1,1,1-trichloroethane
1,1,2,2-tetrachloroethane
Hexachloroethane

Chlorinated Phenols

2-chlorophenol
2,4-dichlorophenol
2,4,6-trichlorophenol
Parametachlorocresol (4-chloro-3-methyl phenol)

Other Chlorinated Organics

Chloroform (trichloromethane)
Carbon tetrachloride
(tetrachloromethane)
Bis(2-chloroethoxy)methane
Bis(2-chloroethyl)ether
2-chloroethyl vinyl ether (mixed)
2-chloronaphthalene
3,3'-dichlorobenzidine
1,1-dichloroethylene
1,2-trans-dichloroethylene
1,2-dichloropropane
1,2-dichloropropylene (1,3-dichloropropene)
Tetrachloroethylene
Trichloroethylene
Vinyl chloride (chloroethylene)
Hexachlorobutadiene
Hexachlorocyclopentadiene
2,3,7,8-tetrachloro-dibenzo-p-dioxin (TCDD)

Haloethers

4-chlorophenyl phenyl ether
2-bromophenyl phenyl ether
Bis(2-chloroisopropyl) ether

Halomethanes

Methylene chloride
(dichloromethane)
Methyl chloride (chloromethane)
Methyl bromide (bromomethane)
Bromoform (tribromomethane)
Dichlorobromomethane
Chlorodibromomethane

Nitroamines

N-nitrosodimethylamine
N-nitrosodiphenylamine
N-nitrosodi-n-propylamine

Phenols (other than chlorinated)

2-nitrophenol
4-nitrophenol
2,4-dinitrophenol
4,6-dinitro-o-cresol (4,6-dinitro-2-methylphenol)
Pentachlorophenol
Phenol
2,4-dimethylphenol

Phthalate Esters

Bis(2-ethylhexyl)phthalate
Butyl benzyl phthalate
Di-n-butyl phthalate
Di-n-octyl phthalate
Diethyl phthalate
Dimethyl phthalate

Polynuclear Aromatic Hydrocarbons (PAHs)

Acenaphthene
1,2-benzanthracene (benzo (a)
anthracene)
Benzo(a)pyrene (3,4-benzo-pyrene)
3,4-benzofluoranthene (benzo(b)
fluoranthene)
11,12-benzofluoranthene (benzo(k)
fluoranthene)
Chrysene
Acenaphthylene
Anthracene
1,12-benzoperylene (benzo(ghi)
perylene)
Fluorene
Fluoranthene
Phenanthrene
1,2,5,6-dibenzanthracene
(dibenzo(a,h)anthracene)
Indeno (1,2,3-cd) pyrene (2,3-o-
phenylene pyrene)
Pyrene

Pesticides and Metabolites

Aldrin
Dieldrin
Chlordane (technical mixture and
metabolites)
Alpha-endosulfan
Beta-endosulfan
Endosulfan sulfate
Endrin
Endrin aldehyde
Heptachlor
Heptachlor epoxide (BHC-
hexachlorocyclohexane)
Alpha-BHC
Beta-BHC
Gamma-BHC (Lindane)
Delta-BHC
Toxaphene

DDT and Metabolites

4,4-DDT
4,4-DDE (p,p-DDX)
4,4-DDD (p,p-DDE)

Polychlorinated Biphenyls (PCBs)

PCB-1242 (Aroclor 1242)
PCB-1254 (Aroclor 1254)
PCB-1221 (Aroclor 1221)
PCB-1232 (Aroclor 1232)
PCB-1248 (Aroclor 1248)
PCB-1260 (Aroclor 1260)
PCB-1016 (Aroclor 1016)

Other Organics

Acrolein
Acrylonitrile
Benzene
Benzidine
2,4-dinitrotolulene
2,6-dinitrotolulene
Ethylbenzene
Isophrone
Naphthalene
Nitrobenzene
Tolulene

Inorganics

Antimony
Arsenic
Asbestos
Beryllium
Cadmium
Chromium (III)
Chromium (VI)
Copper
Cyanide, total
Lead
Mercury
Nickel
Selenium
Silver
Thallium
Zinc

Table K-3
NPDES Permit Application Testing Requirements,
40 CFR 122, Appendix D, Tables II and III

Organic Toxic Pollutants

Volatiles

acrolein
 acrylonitrile
 benzene
 bromoform
 carbon tetrachloride
 chlorobenzene
 chlorodibromomethane
 chloroethane
 2-chloroethylvinyl ether
 chloroform
 dichlorobromomethane
 1,1-dichloroethane
 1,2-dichloroethane
 1,1-dichloroethylene
 1,2-dichloropropane
 1,3-dichloropropylene
 ethyl benzene
 methyl bromide
 methyl chloride
 methylene chloride
 1,1,2,2-tetrachloroethane
 tetrachloroethylene
 toluene
 1,2-trans-dichloroethylene
 1,1,1-trichloroethane
 1,1,2-trichloroethane
 trichloroethylene
 vinyl chloride

Acid Compounds

2-chlorophenol
 2,4-dichlorophenol
 2,4-dimethylphenol
 4,6-dinitro-o-cresol (2-methyl-4,6-dinitrophenol)
 2,4-dinitrophenol
 2-nitrophenol
 4-nitrophenol
 p-chloro-m-cresol (4-chloro-m-cresol)
 pentachlorophenol
 phenol
 2,4,6-trichlorophenol

Base/Neutral

acenaphthene
 acenaphthylene
 anthracene
 benzidine

benzo(a)anthracene
 benzo(a)pyrene
 3,4-benzofluoranthracene
 benzo(ghi)perylene
 benzo(k)fluoranthene
 bis(2-chloroethoxy)methane
 bis(2-chloroethyl)ether
 bis(2-ethylhexyl)phthalate
 4-bromophenyl phenyl ether
 butylbenzyl phthalate
 2-chloronaphthalene
 4-chlorophenyl phenyl ether
 chrysene
 dibenzo(a,h)anthracene
 1,2-dichlorobenzene
 1,3-dichlorobenzene
 1,4-dichlorobenzene
 3-3'-dichlorobenzidine
 diethyl phthalate
 dimethyl phthalate
 di-n-butyl phthalate
 2,4-dinitrotoluene
 2,6-dinitrotoluene
 di-n-octyl phthalate
 1,2-diphenylhydrazine
 fluoranthene
 fluorene
 hexachlorobenzene
 hexachlorobutadiene
 hexachlorocyclopentadiene
 hexachloroethane
 indeno(1,2,3-cd)pyrene
 isophorone
 naphthalene
 nitrobenzene
 N-nitrosodimethylamine
 N-nitrosodi-n-propylamine
 N-nitrosodiphenylamine
 phenanthrene
 pyrene
 1,2,4-trichlorobenzene

Pesticides

aldrin
alpha-BHC
beta-BHC
gamma-BHC
delta-BHC
chlordane
4,4'-DDT
4,4'-DDE
4,4'-DDD
dieldrin
alpha-endosulfan
beta-endosulfan
endosulfan sulfate
endrin
endrin aldehyde
heptachlor
heptachlor epoxide
PCB-1242
PCB-1254
PCB-1221
PCB-1232
PCB-1248
PCB-1260
PCB-1016
toxaphene

Other Toxic Pollutants (Metals and Cyanide) and Total Phenols

antimony, total
arsenic, total
beryllium, total
cadmium, total
chromium, total
copper, total
lead, total
mercury, total
nickel, total
selenium, total
silver, total
thallium, total
zinc, total
cyanide, total
phenols, total

Appendix L: Glossary, Abbreviations/Acronyms, and Units

GLOSSARY

Acid Base Neutrals (ABNs) - Also called semi-volatile organics. A category of organic chemical pollutants. See Appendix K.

Acute - A stimulus severe enough to rapidly induce an effect; in aquatic toxicity tests, an effect observed in 96 hours or less typically is considered acute. When referring to aquatic toxicology or human health, an acute effect is not always measured in terms of lethality.

Acute Criteria- The maximum concentration of a constituent in water that an organism may be exposed to for a total of one hour, once over three years, without dying.

Acute Static Toxicity Test - Test designed to measure water quality effect on mortality. It measures the effect of the whole effluent sample on an organism. Animals are put in a vial with effluent, and the fatal effects are monitored. To calculate water quality standards, the test is run on sensitive animals. The concentration that shows a 95% mortality rate is then multiplied by two.

Activation - An event when the wastewater flow exceeds the holding capacity of the sewer lines and exceeds the hydraulic capacity of the treatment plant causing a diversion of flow to the CSO facilities.

Aeration - The process of adding air to a liquid (e.g. wastewater).

Aliquot - A measured portion of a sample.

Anaerobic Digester - The structure where organic material is broken down by organisms in the absence of oxygen.

Anoxia - The absence of oxygen.

Average Monthly Discharge Limitation - The highest allowable average of “daily discharge” over a calendar month, calculated as the sum of all daily discharges measured during a calendar month divided by the number of daily discharges measured.

Average Weekly Discharge Limitation - The highest allowable average of “daily discharge” over a calendar week, calculated as the sum of all daily discharges measured during a calendar week divided by the number of daily discharges measured during that week.

Bar Screen - A screen made of bars designed to catch large debris (e.g. rags, wood, shoes) in waterways.

Below Detection Limit/Level (BDL) - Values below the Reporting or Quantitation Limit. For further explanation see Appendix K.

Bioaccumulation - The process by which a compound is taken up by an aquatic organism, both from water and through food.

Biochemical - Having to do with a chemical change resulting from the metabolic activities of living organisms.

Biochemical Oxygen Demand (BOD) - The amount of oxygen needed to oxidize inorganic materials and to degrade organic materials by *biochemical reactions* in a certain time at a certain temperature. BOD is used as a measure of organic pollution.

Biomagnification - The process by which the concentration of a compound increases in species occupying successive trophic levels.

BDL - See Below Detection Limit

Bloom - A large mass of algae (microscopic and or macroscopic) in water.

BOD - See Biochemical Oxygen Demand.

Buffering Capacity - Measures the ability of certain water bodies to resist changes in pH from addition of acidic or caustic substances.

CFR- See Code of Federal Regulations

40 CFR Part 122 - Code of Federal Regulations: Protection of the Environment. Part 122 is Administered Permit Programs: The National Pollutant Discharge Elimination System. (Appendix D of 40 CFR 122 lists the Permit Application Requirements.)

Chemical Oxygen Demand (COD) - The amount of oxygen needed for the *chemical oxidation* of chemicals in water.

COD is used to measure the suitability of water for organisms that require oxygen.

Chlorination - The addition of chlorine or chlorine compounds to wastewater. Chlorination is most often done for disinfection purposes.

Choking - A process by which flows that can not be handled by existing pumps are “choked back” into the sewer system, frequently leading to local overflows.

Chronic - A stimulus that lingers or continues for a relatively long period of time, often one-tenth of the life span or more. Chronic should be considered a relative term depending on the life span of an organism. The measurement of a chronic effect can be reduced growth, reduced reproduction, etc., in addition to lethality.

Chronic Criteria - The maximum concentration of a constituent in water that an organism may be exposed to for a total of four days over three years without showing long term, harmful effects, short of mortality. Chronic criteria involve the growth, reproductivity, fertility, and sublethal effects on organisms.

Chronic Reproduction Test - A test designed to measure the chronic effects of wastewater on reproduction and fertility.

Chronic Survival and Growth Test - Test designed to see if any mortality occurs after the chronic criteria have been passed. After the organisms have survived, the size of the animals are measured after seven days and statistically compared to controls.

Clean Water Act (CWA) - Formally referred to as the Federal Water Pollution Control Act or Federal Water Pollution Control Act Amendments of 1972. Pub. L. 92-500, as amended by Pub. L. 95-576, Pub. L. 96-483, and Pub. L. 97-117: 33 U.S.C. 1251 et seq.

COD - See Chemical Oxygen Demand

Code of Federal Regulations (CFR) - Codification of the general and permanent rules of the federal government. CFR 40 covers environmental protection.

Combined Sewer - A sewer receiving both sanitary wastewater and stormwater runoff.

Combined Sewer Overflow Facility - A place where overflow from combined sewers is screened, settled, and chlorinated before being discharged.

Combined Sewer Overflow Pipe - A pipe that discharges overflow from combined sewers in order to prevent back-ups in the sewerage system.

Composite Sample - A sample consisting of a minimum of eight grab samples collected at equal intervals during a 24-hour period (or lesser period if specified) and combined proportional to flow, or a sample continuously collected proportionally to flow over that same time period.

Conventional Parameters/Pollutants - Those pollutants and constituents that are removed from wastewater by conventional treatment. Generally these constituents are settleable solids, biochemical oxygen demand, total suspended solids, oil and grease, total coliform, fecal coliform, residual chlorine, and chlorides.

Conventional Treatment - Well-known or well-established water or wastewater treatment methods, usually consisting of primary and secondary processes and may include advanced or tertiary treatment.

Criteria - The numerical and or narrative elements of water quality standards.

Critical Dilution - Dilution of the effluent required to meet Water Quality Standards.

CWA - See Clean Water Act.

Daily Discharge - The discharge of a pollutant measured during a calendar day or any 24-hours period that reasonably represents the calendar day for purposes of sampling. For pollutants with limitations expressed in units of mass, the daily discharge is calculated as the total mass of the pollutant discharged over the day. For pollutants with limitations expressed in other units of measurements, the daily discharge is calculated as the average measurement of the pollutant over the day.

Designated Use - Specified use of a body of water included in state water quality standards.

Digester - A place where organic matter is broken down either with oxygen (aerobically) or without oxygen (anaerobically).

Disinfection - The destruction of pathogens (e.g. fecal coliform bacteria) in a water source or wastewater.

Effluent - The wastewater or other water coming out of a treatment facility or process.

Effluent Limitation - Any restriction imposed by the Director (the person authorized to sign NPDES permits by EPA and/or the State) on quantities, discharge rates, and concentrations of “pollutants” which are “discharged” from “point sources” into “waters of the United States,” the waters of the “contiguous zone,” or the ocean.

Eutrophication - The natural process by which a body of water ages. Nutrients stimulate plant growth and lakes, estuaries, and bays evolve into bogs or marshes. Effluent high in nutrient loadings cause excessive plant growth that accelerates eutrophication.

Fecal Coliform - Bacteria found in the wastes of warm-blooded animals. Fecal coliform is used as an indicator that disease causing bacteria and viruses are present. It is a component of Total Coliform.

Floatables - Constituents of wastewater that rise to the surface in the settling process, consisting mainly of oil, grease, and plastics.

Grab Sample - An individual sample collected in a period of less than 15 minutes.

Gravity Facility - A combined sewer overflow facility that receives flows by gravity (descending gradients from source to outfall) and no pumping is required.

Grit - Heavy suspended mineral matter in wastewater like sand and gravel.

Grit Chamber - A detention tank where grit is separated by sedimentation (grit settles to the bottom). The settling is controlled by the velocity of the water.

Headworks - A structure where wastewater are screened out and grit and other solids are trapped before the wastewater is pumped to a treatment facility.

Human Health Criteria - Estimated concentrations or quantities of chemicals that can be expected to occur in the environment in water, sediment, or food and that are not likely to pose a significant risk to the exposed human population. Human health criteria are published under section 304(a) of the CWA and are based on the latest scientific information. This information is updated and issued to the states to serve as guidance for the development of criteria.

Hydrocarbons - Chemical compounds only containing hydrogen and carbon.

Hypochlorite - The chemical used for chlorine disinfection of wastewater (either calcium, sodium, or lithium hypochlorite).

Hypoxia - The state of very low oxygen concentration.

IDL - See Instrument Detection Limit.

I/I - Infiltration and Inflow.

Infiltration - Groundwater that enters sewer pipes through cracks.

Inflow - Water that enters sewer pipes through illegal connections and storm water runoff.

Inorganic - Not containing carbon.

Influent - Wastewater or other water going into treatment facility or process.

Instrument Detection Limit (IDL) - The smallest amount of a substance a particular instrument is capable of detecting. See Appendix K for further explanation.

Interceptor - A large sewerage line collecting water from smaller sewerage pipes.

J values - Values between the Method Detection Limit and the Quantitation (or Reporting) Limit. See Appendix J for further explanation.

Lethal Concentration 50% (LC50) - The concentration of effluent in a sample that causes mortality to 50% of the test population at a specific time of observation.

Limiting Nutrient - In a given ecosystem, the limiting nutritional factor that controls the growth of plants or animals. Usually the limiting nutrient for plant growth is nitrogen in the marine environment and phosphorus in the fresh water environment. The limiting nutrient can also be thought of as the specific nutrient that will have the most impact on a receiving body of water (for example, the acceleration eutrophication of fresh water bodies caused by phosphorus in wastewater effluent).

Local Limits - The development of specific limits as part of MWRA's General Pretreatment Program: "The permittee shall develop and enforce specific effluent limits for industrial users, and all other users, as appropriate, pursuant to 40 CFR 403.5."

Lowest Observed Effect Concentration (LOEC) - The lowest concentration of effluent to which organisms are exposed in a life cycle or partial life cycle test which contains an adverse effect (on survival, growth, and reproduction).

Maximum Acceptable Toxicant Concentration (MATC) - The effluent concentration that may be present in a receiving water body without causing significant harm to productivity or other uses. The MATC is determined by the results of chronic tests of either a partial life cycle with sensitive life stages or a full life cycle of the test organism. The MATC is the geometric mean of the No Observed Effect Concentration and the Lowest Observed Effect Concentration.

Maximum Daily Discharge Limitation - The highest allowable daily discharge.

MBAS - See Methylene Blue Anion Surfactant

MDL - See Method Detection Limit

Metals - A group of priority pollutants. See Appendix K for a complete list.

Method Detection Limit (MDL) - The smallest amount of a substance that can be detected above background noise by following a particular method of analysis. See Appendix K for further explanation.

Methylene Blue Anion Surfactant - See Surfactant.

Mixing Zone - Area where discharged effluent is first diluted. The area is extended to cover the secondary mixing in the ambient water body. A mixing zone is an allocated impact zone where water quality criteria can be exceeded as long as toxic conditions are prevented.

National Pollutant Discharge Elimination System (NPDES) - The national program for issuing, modifying, revoking and reissuing, terminating, monitoring, and enforcing permits, and imposing and enforcing pretreatment requirements, under sections 307, 402, and 405 of the Clean Water Act (CWA). The term includes an “approved program.”

Nine Minimum Controls - Part of the EPA’s CSO Policy. The Nine Minimum Controls are:

- 1) Proper operation and regular maintenance (O&M) programs for the sewer system and combined sewer overflow points
- 2) Maximum use of the collection system for storage
- 3) Review and modification of the pretreatment programs to assure CSO impacts are minimized
- 4) Maximization of flow to the POTW for treatment
- 5) Prohibition of CSO discharges during dry weather
- 6) Control of solid and floatable materials in CSO discharges
- 7) Pollution prevention programs that focus on contaminant reduction activities
- 8) Public notification to ensure that the public receives adequate notification of CSO occurrences and CSO impacts
- 9) Monitoring to effectively characterize CSO impacts and the efficacy of CSO controls.

Nitrification - The conversion of ammonia and nitrite to nitrate.

No Observed Acute Level (NOAL) - The highest concentration of effluent to which organisms are exposed in a short-term test in which at least 90% of the test organisms survive.

No Observed Effect Concentration (NOEC) - The highest concentration of effluent to which organisms are exposed in a life cycle or partial life cycle test which contains no adverse effects (on growth, survival, and reproduction).

NPDES - See National Pollutant Discharge Elimination System

Nutrient - Any element or compound essential as raw material for organism growth and development. Examples: phosphorus and nitrogen.

Oil and Grease - Fats, oils, and grease from animal and plant derivation. Also called FOGs.

Organic Compounds - Volatiles, Acid Compounds, Base/Neutral, and Pesticides. Organics are listed in 40 CFR Ch. 1 Appendix D under CWA Section 307(a). See Appendix K for a complete list.

Orthophosphorus - A form of phosphorus, included in nutrients.

Outfall - the site of initial discharge

PAH - See Polynuclear Aromatic Hydrocarbon

Pesticides/PCBs - Subdivision of priority pollutants. See Appendix L for a complete list.

Petroleum Hydrocarbon (PHC) - Oil and grease from petroleum derivation.

pH - The negative log of the hydrogen ion concentration used to express acidity (<7) and alkalinity (>7).

PHC - See Petroleum Hydrocarbon.

Pollutant - Dredged soil, solid waste, incinerator residue, filter backwash, sewage, garbage, sewage sludge, munitions, chemicals wastes, biological materials, radioactive materials, (except those regulated under the Atomic Energy Act of 1954, as amended (42 U.S.C. 2011 *et seq.*)), heat, wrecked or discarded equipment, rock, sand, cellar dirt and industrial, municipal, and agricultural waste discharged into water.

It does not mean: (a) Sewage from vessels; or (b) Water, gas, or other material which is injected into a well to facilitate production of oil or gas, or water derived in association with oil and gas production and disposed or in a well, if the well used either to facilitate production or for disposal purposes is approved by authority of the State in which the well is located, and if the State in which the well is located, and if the State determines that the injection or disposal will not result in the degradation of ground or surface water resources.

Polynuclear Aromatic Hydrocarbon (PAH) - A type of semi-volatile organic. Also known as polycyclic aromatic hydrocarbon.

POTW - See Publicly Owned Treatment Work

Preaeration - The process by which air is added to primary influent to help in the removal of gases, floatation of grease, addition of oxygen, and in the settling or coagulation of wastewater.

Prechlorination - The addition of chlorine to primary influent at or near the beginning of the treatment facility/process.

Primary Settling - The detention of wastewater as part of primary treatment to settle out solids (sludge) and collect

floatables (scum).

Primary Treatment - Screening and settling of wastewater.

Priority Pollutants - Refers to some of the chemicals listed in 40 CFR Ch. 1 Appendix D under Section 307(a) of the CWA.

There are 65 compounds and families of compounds that are among the most persistent, prevalent, and toxic of chemicals known to man. These 65 compounds or families of compounds have been translated into 126 individual pollutants. See Appendix K, Table K-2 for the complete list.

Priority Pollutant Scan - A series of chemical analyses to identify the presence of priority pollutants.

Publicly Owned Treatment Work (POTW) - Any facility or system used in the treatment (including recycling and reclamation) of municipal sewage or industrial wastes of liquid nature that is owned by a "State" or a "municipality."

This definition includes sewers, pipes, or other conveyances only if they convey wastewater to a POTW providing treatment.

Pumping Station - Structures where wastewater from low-lying areas is pumped.

Quantitation Limit - See Reporting Limit.

Removal Rate - or Percent Removal. Defined as the influent concentration minus the effluent concentration, divided by the influent concentration.

Reporting Limit - The smallest concentration that can be quantified. On a graph of pollutant concentration versus instrument response, the reporting limit is the smallest concentration where the linear relationship holds before starting to curve as the pollutant concentration goes to zero. Also called the Quantitation Limit. See Appendix J for further explanation.

Residuals - Matter left over by treatment processes including screenings, scum, and sludge.

Screening - The process by which sewage from interceptors first goes through headworks where grit and large objects like leaves, sticks, and hygiene products (like tampon applicators and condoms) are screened out.

Screenings - The objects that are collected by the process of screening.

Scum - Solids that float to the top of wastewater.

Secondary Treatment - The treatment of wastewater beyond solids and grit removal. The process decreases the organic load.

Sedimentation - The process by which solids are allowed to settle by gravity.

Sedimentation Tank - Tanks used to detain wastewater while the solids settle out.

Semi-Volatile Organics - Also known as Acid Base Neutrals (ABNs). A subcategory of organic pollutants. See Appendix K for a complete list.

Separate Sewer - A sewerage system divided into a storm sewer and a sanitary sewer.

Settleable Solids - The estimated amount of sludge that will settle by sedimentation. It is a fraction of the suspended-solids.

Settled Solids - Sludge. (See sludge.)

Sewage - Any wastes, including wastes from humans, households, commercial establishments, industries, and storm water runoff, that are discharged to or otherwise enter a POTW.

Sludge - Solids, residues, and precipitate separated from or created in sewage by the unit processes of a POTW.

SOP - See System Optimization Plan or Standard Operating Procedures

Stratification - The separation of water into layers characterized by thermal differences.

Standard Operating Procedures (SOP) - Documented protocols for plant operation, laboratory procedures, etc.

Surcharging - When the capacity of the sewer is insufficient and sewage escapes through a manhole.

Surfactant - Surface-active agent. Large organic molecules that cause foaming. They are usually found in detergents.

System Optimization Plan (SOP) - Hydraulic improvements that, in conjunction with ongoing programs of municipal sewerage agencies, might promote a balanced hydraulic system, including optimization of the collector/interceptor system upstream of regulators, to ensure that the storage and transport capacity of the system is maximized within constraints unalterable except for major structural modifications.

Thickener - The structure where sludge is sent to be thickened by removing water.

TKN - See Total Kjeldahl Nitrogen.

Total Coliform - Bacteria found in decaying matter, feces, and soil. It is used as an indicator of pathogens that are present in wastewater. (Fecal Coliform is a component of Total Coliform.)

Total Kjeldahl Nitrogen (TKN) - The total organic and ammonia nitrogen.

Total Phosphorus - A measure of all the forms of phosphorus, a nutrient, found in water (orthophosphates, polyphosphates, and organic phosphates).

Total Suspended Solids (TSS) - The sum of insoluble solids that either float on the surface of, or are in suspension in water, wastewater, or other liquids.

Toxic Pollutant - Any pollutant listed as toxic in Appendix D of 40 CFR Part 122, under Section 307(a)(1) of CWA.

Toxics - Pollutants that have a toxic effect on living organisms. The “priority pollutants” of CWA Section 307(a) are a subset of this group of pollutants.

Toxicity Test - A procedure to determine the toxicity of a chemical or an effluent using living organisms. A toxicity test measures the degree of effect on exposed test organisms of a specific chemical or effluent.

TSS - See Total Suspended Solids.

Twelve Month Running Average - The monthly average computed using the specific month and the previous 11 months.

Unregulated Community - Dischargers not required to have Permits to discharge into MWRA sewerage system. They are not regulated or required to meet Local Limits, nor are they regulated under the Local Limits Discharge Program.

Vertical Mixing - The vertical movement of the water column caused by wind, and/or density and/or temperature differences.

Volatile Organic Acid (VOA) - Same as Volatile Organic Compound.

Volatile Organic Compound (VOC) - Same as Volatile Organic Acid.

Volatile Solids - Those solids of a suspended solid sample that are burned off in a muffle oven at 550 ± 50 °C.

Water Quality - The chemical, biological, and physical conditions of a body of water.

Water Quality Criteria - Specific levels of pollutants that would make a body of water unsuitable for its designated use (i.e. harmful if used for drinking, swimming, farming, fishing, or industrial processes).

Water Quality Standard - A law or regulation that consists of: the beneficial designated use or uses of a water body; the numeric and narrative water quality criteria that are necessary to protect the use or uses of that particular water body; and an antidegradation statement.

Whole Effluent Toxicity (WET) - The total toxic effect of effluent, not chemical specific but rather the cumulative effect, whether it be synergistic or antagonistic, of the chemicals found in the effluent.

ABBREVIATIONS, ACRONYMS AND UNITS

Abbreviations, Acronyms

ABNs - Acids Bases Neutrals
BDL - Below Detection Limit
BOD - Biochemical Oxygen Demand
BWSC - Boston Water and Sewer Commission
CFR - Code of Federal Regulations
CSO - Combined Sewer Overflow
CWA - Clean Water Act
DEP - Massachusetts Department of Environmental Protection
DITP - Deer Island Treatment Plant
ENQUAD - Environmental Quality Department
EPA - United States Environmental Protection Agency
FY - Fiscal Year
IDL - Instrument Detection Level
I/I - Infiltration and Inflow
LC50 - Median Lethal Concentration
LD50 - Median Lethal Dose
LOAEL - Lowest Observed Adverse Effect Level
LOEC - Lowest Observed Effect Concentration
MATC - Maximum Acceptable Toxicant Concentration
MDC - Metropolitan District Commission
MDL - Method Detection Limit
MPN - Most Probable Number
MWRA - Massachusetts Water Resources Authority
NITP - Nut Island Treatment Plant
NOAL - No Observed Acute Level
NOEC - No Observed Effect Concentration
NPDES - National Pollutant Discharge Elimination System
PAH - Polycyclic (or Polynuclear) Aromatic Hydrocarbon
PCB - Polychlorinated Biphenyl
PHC - Petroleum Hydrocarbon
POTW - Publicly Owned Treatment Work
SD - Standard Deviation
SOP - Standard Operating Procedures or System Optimization Plan
SSO - Sanitary Sewer Overflow
TKN - Total Kjeldahl Nitrogen
TRAC - Toxic Reduction and Control Department
TSS - Total Suspended Solids
VOA - Volatile Organic Acid
VOC - Volatile Organic Compound
WET - Whole Effluent Toxicity [test]

Units

in/yr - inches per year	MG - million gallons
L – liter	mgd - million gallons per day
lbs – pounds	mg/L - milligrams per liter
lbs/day - pounds per day	µg/L (or ug/L) - micrograms per liter
mL/L - milliliters per liter	