

NPDES compliance summary report,
fiscal year 1998

Massachusetts Water Resources Authority

Environmental Quality Department
Report ENQUAD 99-03



NPDES COMPLIANCE SUMMARY REPORT
Fiscal Year 1998

Douglas B. MacDonald
Executive Director

John F. Fitzgerald, Director
Sewerage Division

Dr. Michael F. Delaney, Acting Director
Environmental Quality Department

By
Esther Wolf Graf
Grace Bigornia-Vitale

Technical Report No. 99-03
NPDES Compliance Unit
Environmental Quality Department
Sewerage Division
Massachusetts Water Resources Authority
100 First Avenue
Charlestown Navy Yard
Boston, MA 02129
(617) 242-6000

Acknowledgements

This report was written by Esther Wolf Graf and Grace Bigornia-Vitale, Program Manager. Kelly Coughlin, Kara Fothergill and Matt Horan assisted in downloading and analyzing data. Maury Hall, Mark Sullivan, Kelly Coughlin and Peter Roloff all contributed to and/or reviewed this report. Jennifer Sullivan's work on the FY97 report provided a strong basis on which to build this year's report. The work done by Erin Graham and Alex Pancic for previous years' reports is incorporated in this report. This report was reviewed and copyedited by Sally Carroll.

Citation:

Graf EW, Bigornia-Vitale G. 1999. NPDES compliance summary report, fiscal year 1998. Boston: Massachusetts Water Resources Authority. Report ENQUAD 99-03. 247 p.

Table of Contents

LIST OF TABLES

LIST OF FIGURES

EXECUTIVE SUMMARY	ES-1
TREATMENT PLANTS.....	ES-1
Deer Island Treatment Plant.....	ES-3
Nut Island Treatment Plant.....	ES-6
COMBINED SEWER OVERFLOW FACILITIES	ES-7
SYSTEM CAPACITY	ES-9
FUTURE OUTLOOK.....	ES-11
I. INTRODUCTION.....	I-1
II DEER ISLAND TREATMENT PLANT	II-1
II.A MONITORING RESULTS	
II.A.1 Influent Characteristics	II-1
II.A.1.a Flow.....	II-1
II.A.1.b Conventional Parameters and Nutrients	II-4
II.A.1.c Priority Pollutants.....	II-7
II.A.2 Effluent Characteristics.....	II-9
II.A.2.a Conventional Parameters.....	II-9
II.A.2.b Nutrients.....	II-13
II.A.2.c Priority Pollutants.....	II-13
II.A.2.d Whole Effluent Toxicity.....	II-15
II.A.2.e Bioaccumulation.....	II-16
II.B DISCUSSION	
II.B.1 Compliance with Regulatory Limits	II-20
II.B.2 Effluent Quality Compared to Water Quality Standards	II-25
III NUT ISLAND TREATMENT PLANT	III-1
III.A MONITORING RESULTS	
III.A.1 Influent Characteristics	III-1
III.A.1.a Flow.....	III-1
III.A.1.b Conventional Parameters and Nutrients.....	III-3
III.A.1.c Priority Pollutants.....	III-6
III.A.2 Effluent Characteristics	III-8
III.A.2.a Conventional Parameters.....	III-8
III.A.2.b Nutrients.....	III-8
III.A.2.c Priority Pollutants.....	III-9
III.A.2.d Whole Effluent Toxicity	III-13

III.B DISCUSSION	
III.B.1 Compliance with Regulatory Limits	III-14
III.B.2 Effluent Quality Compared to Water Quality Standards	III-20
IV COMBINED SEWER OVERFLOW FACILITIES	IV-1
IV.A COTTAGE FARM COMBINED SEWER OVERFLOW FACILITY	
IV.A.1 Activations.....	IV-1
IV.A.2 Conventional Parameters.....	IV-4
IV.A.3 Priority Pollutants.....	IV-5
IV.B PRISON POINT COMBINED SEWER OVERFLOW FACILITY	
IV.B.1 Activations.....	IV-6
IV.B.2 Conventional Parameters	IV-8
IV.B.3 Priority Pollutants	IV-9
IV.C SOMERVILLE MARGINAL COMBINED SEWER OVERFLOW FACILITY	
IV.C.1 Activations.....	IV-10
IV.C.2 Conventional Parameters	IV-13
IV.C.3 Priority Pollutants	IV-13
IV.D CONSTITUTION BEACH COMBINED SEWER OVERFLOW FACILITY	
IV.D.1 Activations.....	IV-14
IV.D.2 Conventional Parameters.....	IV-17
IV.E FOX POINT COMBINED SEWER OVERFLOW FACILITY	
IV.E.1 Activations	IV-18
IV.E.2 Conventional Parameters	IV-20
IV.F COMMERCIAL POINT COMBINED SEWER OVERFLOW FACILITY	
IV.F.1 Activations	IV-20
IV.F.2 Conventional Parameters	IV-23
V TRANSPORT SYSTEMS	V-1
V.A NORTH SYSTEM	
V.A.1 Headworks Choking	V-1
V.A.2 Sanitary Sewer Overflows	V-3
V.B SOUTH SYSTEM	
V.B.1 Sanitary Sewer Overflows	V-4

APPENDICES

APPENDIX A DEER ISLAND TREATMENT PLANT DATA TABLES

APPENDIX B NUT ISLAND TREATMENT PLANT DATA TABLES

APPENDIX C COTTAGE FARM CSO FACILITY DATA TABLES

APPENDIX D PRISON POINT CSO FACILITY DATA TABLES

APPENDIX E SOMERVILLE MARGINAL CSO FACILITY DATA TABLES

APPENDIX F CONSTITUTION BEACH CSO FACILITY DATA TABLES

APPENDIX G FOX POINT CSO FACILITY DATA TABLES

APPENDIX H COMMERCIAL POINT CSO FACILITY DATA TABLES

APPENDIX I NPDES MONITORING REQUIREMENTS

I.1 PERMITS AND COMPLIANCE ORDER.....I-2
 I.1.a NPDES Permit.....I-2
 I.1.b Court OrderI-2
I.2 MONITORING PROGRAMSI-8
 I.2.a Treatment Plant Monitoring ProgramI-8
 I.2.b Combined Sewer Overflow Facilities Monitoring ProgramI-9
 I.2.c Sewer System Monitoring ProgramI-9
I.3 TREATMENT OF RESULTS.....I-10

APPENDIX J AN OVERVIEW OF MWRA SEWERAGE SYSTEM AND FACILITIES

J.1 NORTH SYSTEM..... J-4
 J.1.a Pump Stations..... J-6
 J.1.b Headworks J-7
 J.1.c Deer Island Treatment Plant..... J-7
 J.1.d Combined Sewer Overflow Facilities J-13
J.2 SOUTH SYSTEM J-17
 J.2.a Pump Stations..... J-19
 J.2.b Nut Island Treatment Plant J-20
J.3 SANITARY SYSTEM OVERFLOWS J-24

APPENDIX K INSTRUMENT DETECTION LIMITS, METHOD DETECTION LIMITS, AND QUANTITATION LIMITS: A BRIEF DESCRIPTION

APPENDIX L PRIORITY POLLUTANTS AND OTHER PARAMETERS

APPENDIX M GLOSSARY, ABBREVIATIONS/ACRONYMS, AND UNITS

List of Tables

Table 1	Classification of Deer Island and Nut Island Influent	ES-3
Table 2	Sanitary Sewer Overflows, FY98.....	ES-10
Table II.A.1	Classification of Deer Island Influent, FY98.....	II-4
Table II.A.2	Deer Island Influent Characterization, FY93-FY98	II-5
Table II.A.3	Deer Island Removal Efficiency, FY98.....	II-9
Table II.A.4	Removal Efficiencies vs. Degree of Secondary Treatment, FY98	II-10
Table II.A.5	Deer Island Effluent Characterization, FY93-FY98.....	II-11
Table II.A.6	Deer Island Effluent, Results of Toxicity Testing, FY98	II-16
Table II.A.7	Concentrations of Metals Bioaccumulating in Boston Harbor Mussels.....	II-17
Table II.A.8	Concentrations of Contaminants Bioaccumulating in Boston Harbor Mussels...	II-18
Table II.B.1	Deer Island Effluent Quality Compared to Interim Limits.....	II-20
Table II.B.2	NPDES Violations at Deer Island, FY94-FY98	II-21
Table II.B.3	Comparison of Deer Island Treatment Plant Effluent with Water Quality Criteria, FY98	II-26
Table III.A.1	Classification of Nut Island Influent, FY98	III-3
Table III.A.2	Nut Island Influent Characterization, FY93-FY98	III-4
Table III.A.3	Nut Island Removal Efficiency, FY98	III-8
Table III.A.4	Nut Island Effluent Characterization, FY93-FY98.....	III-11
Table III.A.5	Nut Island Effluent, Results of Toxicity Testing, FY98.....	III-13
Table III.B.1	Nut Island Effluent Quality Compared to Interim Limits.....	III-14
Table III.B.2	NPDES violations at Nut Island, FY94-FY98.....	III-15
Table III.B.3	Comparison of Nut Island Treatment Plant Effluent With Water Quality Criteria, FY98	III-20
Table IV.A.1	Cottage Farm CSO Activations Summary.....	IV-2
Table IV.A.2	Cottage Farm CSO Influent and Effluent Characteristics, FY98	IV-5
Table IV.A.3	Cottage Farm Metals, FY98	IV-5
Table IV.B.1	Prison Point CSO Activations Summary.....	IV-6
Table IV.B.2	Prison Point CSO Influent and Effluent Characteristics, FY98.....	IV-9
Table IV.B.3	Prison Point Metals, FY98.....	IV-9
Table IV.C.1	Somerville Marginal CSO Activations Summary.....	IV-10
Table IV.C.2	Somerville Marginal CSO Influent and Effluent Characteristics, FY98	IV-13
Table IV.C.3	Somerville Marginal Metals, FY98	IV-14
Table IV.D.1	Constitution Beach CSO Activations Summary	IV-15
Table IV.D.2	Constitution Beach CSO Influent and Effluent Characteristics, FY98.....	IV-17
Table IV.E.1	Fox Point CSO Activations Summary	IV-18
Table IV.E.2	Fox Point CSO Influent and Effluent Characteristics, FY98.....	IV-20
Table IV.F.1	Commercial Point CSO Activations Summary	IV-21
Table IV.F.2	Commercial Point CSO Influent and Effluent Characteristics, FY98.....	IV-23
Table V.A.1	Sanitary Sewer Overflows, North System, FY97 and FY98	V-4
Table V.B.1	Sanitary Sewer Overflows, South System, FY97 and FY98	V-4

List of Figures

Figure 1	Deer Island and Nut Island Flows	ES-2
Figure 2	Deer Island TSS and BOD Removal Rates	ES-4
Figure 3	NPDES Violations at Deer Island.....	ES-5
Figure 4	NPDES Violations at Nut Island	ES-6
Figure 5	CSO Facility Activations, FY92-FY98	ES-8
Figure 6	CSO Volume Treated, FY92-FY98.....	ES-8
Figure 7	Choking, FY92-FY98	ES-9
Figure II.A.1	Deer Island Flows Compared to Precipitation, FY98.....	II-2
Figure II.A.2	Deer Island Average Flow Compared to Precipitation, FY88-FY98	II-3
Figure II.A.3	Frequency Distribution of Deer Island Flow, FY98.....	II-4
Figure II.A.4	Deer Island Average Influent Metals Loadings, FY92-FY98	II-7
Figure II.A.5	Deer Island Average Influent Organics Loadings, FY94-FY98.....	II-8
Figure II.A.6	Deer Island Effluent Nutrient Concentrations, FY93-FY98.....	II-13
Figure II.A.7	Deer Island Average Effluent Metals Loadings, FY89-FY98.....	II-14
Figure II.A.8	Deer Island Average Effluent Organics Loadings, FY94-FY98	II-14
Figure II.B.1	Deer Island Treatment Plant Effluent BOD Trend Analysis, FY98	II-22
Figure II.B.2	Deer Island Treatment Plant Effluent TSS Trend Analysis, FY98	II-22
Figure II.B.3	Deer Island Treatment Plant Effluent Fecal Coliform Trend Analysis, FY98 ...	II-23
Figure II.B.4	Deer Island Treatment Plant Effluent Total Coliform Trend Analysis, FY98	II-23
Figure II.B.5	Deer Island Treatment Plant Effluent pH Trend Analysis, FY98	II-24
Figure II.B.6	Deer Island Treatment Plant Effluent Settleable Solids Trend Analysis, FY98..	II-25
Figure III.A.1	Nut Island Flows Compared to Precipitation, FY98.....	III-2
Figure III.A.2	Nut Island Average Flows, FY98 Compared to Historical Data	III-2
Figure III.A.3	Nut Island Average Daily Flow Compared to Precipitation, FY88-FY98	III-3
Figure III.A.4	Nut Island Average Influent Metals Loadings, FY92-FY98	III-6
Figure III.A.5	Nut Island Average Influent Organics Loadings, FY94-FY98.....	III-7
Figure III.A.6	Nut Island Effluent Nutrient Concentrations, FY93-FY98.....	III-9
Figure III.A.7	Nut Island Average Effluent Metals Loadings, FY89-FY98.....	III-10
Figure III.A.8	Nut Island Average Effluent Organics Loadings, FY94-FY98	III-10
Figure III.B.1	Nut Island Treatment Plant Effluent BOD Trend Analysis, FY98	III-16
Figure III.B.2	Nut Island Treatment Plant Effluent TSS Trend Analysis, FY98	III-17
Figure III.B.3	Nut Island Treatment Plant Effluent Fecal Coliform Trend Analysis, FY98 ...	III-18
Figure III.B.4	Nut Island Treatment Plant Effluent Total Coliform Trend Analysis, FY98	III-18
Figure III.B.5	Nut Island Treatment Plant Effluent pH Trend Analysis, FY98	III-19
Figure III.B.6	Nut Island Treatment Plant Effluent Settleable Solids Trend Analysis, FY98 .	III-19
Figure IV.A.1	Cottage Farm CSO Activations, FY89-FY98.....	IV-3
Figure IV.A.2	Cottage Farm Total Volume Treated Compared to Precipitation, FY89-FY98 ..	IV-3
Figure IV.A.3	Frequency Distribution of Rainfall, Cottage Farm, FY98.....	IV-4
Figure IV.B.1	Prison Point CSO Activations, FY89-FY98.....	IV-7
Figure IV.B.2	Prison Point Total Volume Treated Compared to Precipitation, FY89-FY98.....	IV-7
Figure IV.B.3	Frequency Distribution of Rainfall, Prison Point, FY98	IV-8
Figure IV.C.1	Somerville Marginal CSO Activations, FY89-FY98	IV-11
Figure IV.C.2	Somerville Marginal Total Volume Treated Compared to Precipitation, FY89-FY98.....	IV-12

Figure IV.C.3	Frequency Distribution of Rainfall, Somerville Marginal, FY98.....	IV-12
Figure IV.D.1	Constitution Beach CSO Activations, FY90-FY98.....	IV-15
Figure IV.D.2	Constitution Beach Total Volume Treated Compared to Precipitation, FY90-FY98.....	IV-16
Figure IV.D.3	Frequency Distribution of Rainfall, Constitution Beach, FY98	IV-16
Figure IV.E.1	Fox Point CSO Activations, FY91-FY98	IV-18
Figure IV.E.2	Fox Point Total Volume Treated Compared to Precipitation, FY91-FY98.....	IV-19
Figure IV.E.3	Frequency Distribution of Rainfall, Fox Point, FY98	IV-19
Figure IV.F.1	Commercial Point CSO Activations, FY92-FY98	IV-21
Figure IV.F.2	Commercial Point Total Volume Treated Compared to Precipitation, FY92-FY98.....	IV-22
Figure IV.F.3	Frequency Distribution of Rainfall, Commercial Point, FY98.....	IV-22
Figure V.A.1	Choking, FY92-FY98	V-1
Figure V.A.2	Rain-Related Choking, FY92-FY98	V-2
Figure V.A.3	Testing/Maintenance Choking, FY92-FY98	V-3

Executive Summary

This report presents and summarizes monitoring and compliance data collected and analyzed by the Massachusetts Water Resources Authority (MWRA) NPDES Compliance Unit from July 1997 to June 1998. The Fiscal Year Summary Report, while not a regulatory requirement, provides a useful documentation of influent and effluent quality trends over the course of a full year.

Treatment Plants

MWRA is required under its National Pollutant Discharge Elimination System (NPDES) permit to monitor its two wastewater treatment plants at Deer Island and Nut Island for specified parameters. The permit calls for secondary treatment, but both plants are regulated under court-ordered interim limits, since the secondary treatment facilities at Deer Island were not completed when the permit was issued. Secondary treatment began at Deer Island in early FY98 with the introduction of the first battery of treatment, Battery A (although Deer Island is still regulated under the interim limits). In mid-FY98, Battery B was brought on-line. By March 1998, both batteries of treatment were in use. Full secondary treatment at Deer Island will include three batteries of treatment; the third battery of secondary treatment is expected to come on-line in FY00.

In April, May and June of FY98, increasing volumes of the Nut Island Treatment Plant effluent were sent through the new Inter-Island Tunnel to Deer Island to test the equipment and systems (the South System Pump Station at Deer Island, and the Inter-Island Tunnel) that transfer the South System flow to Deer Island. In April, about 50% of the Nut Island effluent was sent to Deer Island. In May, that fraction increased to 75%, and in June, 90% of the effluent was sent to Deer Island. At the start of FY99, all South System flow will be transferred from Nut Island to Deer Island for secondary treatment, and the Nut Island Treatment Plant will be decommissioned. The area around the old Nut Island settling tanks will be converted into a recreational park.

In FY99 the Deer Island Treatment Plant will be operating under a new NPDES permit. The next milestone for the Boston Harbor Project is the start up of the new 9.5-mile outfall tunnel that will carry treated wastewater from Deer Island to be discharged in Massachusetts Bay. The outfall tunnel is expected to open in FY00. The new NPDES permit will allow for discharge from this tunnel.

Figure 1 shows the totaled Deer Island and Nut Island flows during each month of FY98, comparing the flow with the total monthly flows averaged from the previous eight years. Note that in April, May and June of FY98, a portion of the Nut Island effluent was sent to Deer Island. For the purpose of Figure 1, the Deer Island total flows are corrected for these portions of the flow, so that they are not double-counted in the graph. Record rainfall in the months of May and June resulted in high flows going through both plants.

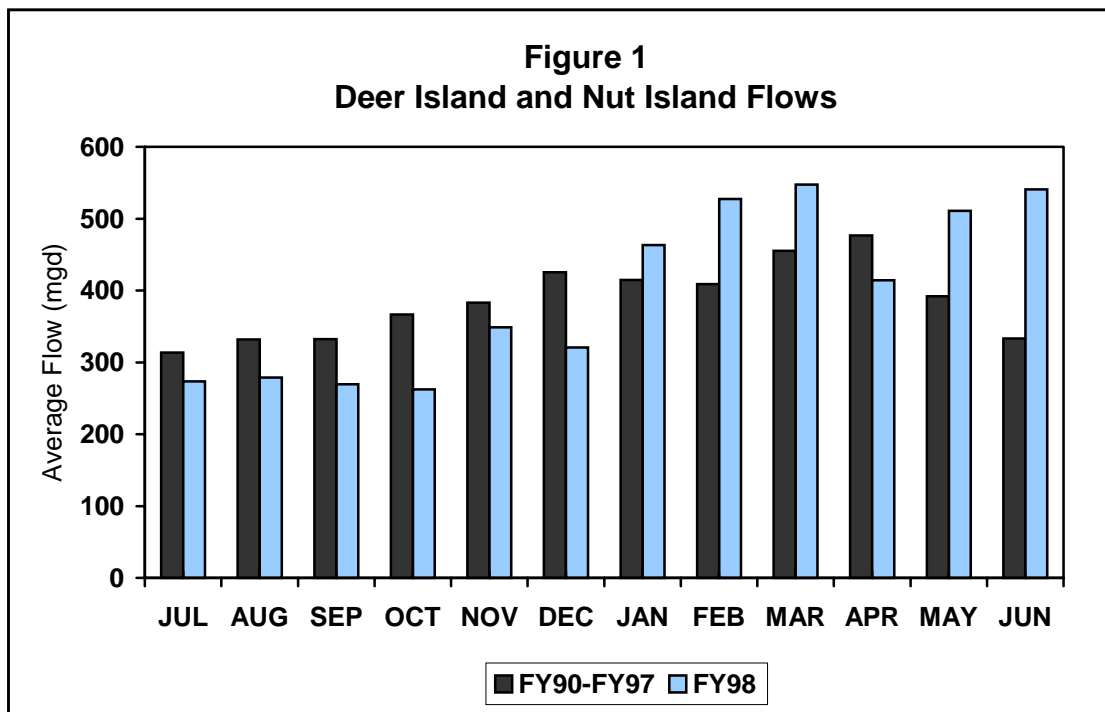

As Table 1 indicates, the influent entering both plants could be classified as weak to medium with regard to conventional parameters.¹

<u>Parameter</u>	<u>Deer Island</u>	<u>Nut Island</u>	<u>Weak</u>	<u>Medium</u>	<u>Strong</u>
TSS	141*	129	100	200	350
BOD	145*	121	100	200	300
TKN	26	30	20	40	85
Ammonia	14	19	12	25	50

*TSS and BOD concentrations for Deer Island include the contributions from the South System (i.e., Nut Island effluent) during the months of April, May and June, 1998.

Deer Island Treatment Plant

The results of improved primary treatment at the new Deer Island Treatment Plant (DITP) are becoming apparent. Since the new primary treatment plant was brought on-line in FY95, the removal rates for both TSS and BOD have improved significantly (see Figure 2). In FY96 and FY97, removal efficiencies compared favorably to theoretical removal efficiencies for primary treatment, with TSS removal above the theoretical range and the BOD removal rate within the theoretical range. In FY98, the efficiencies continued to improve, especially for BOD, with a removal rate well above the theoretical range.² The introduction of secondary treatment in FY98 contributed to this improved efficiency.

¹ Metcalf & Eddy, Inc. 1972. Wastewater Engineering: Collection, Treatment, Disposal. New York: McGraw-Hill Book Company. p. 231.

² Ibid. p. 446.

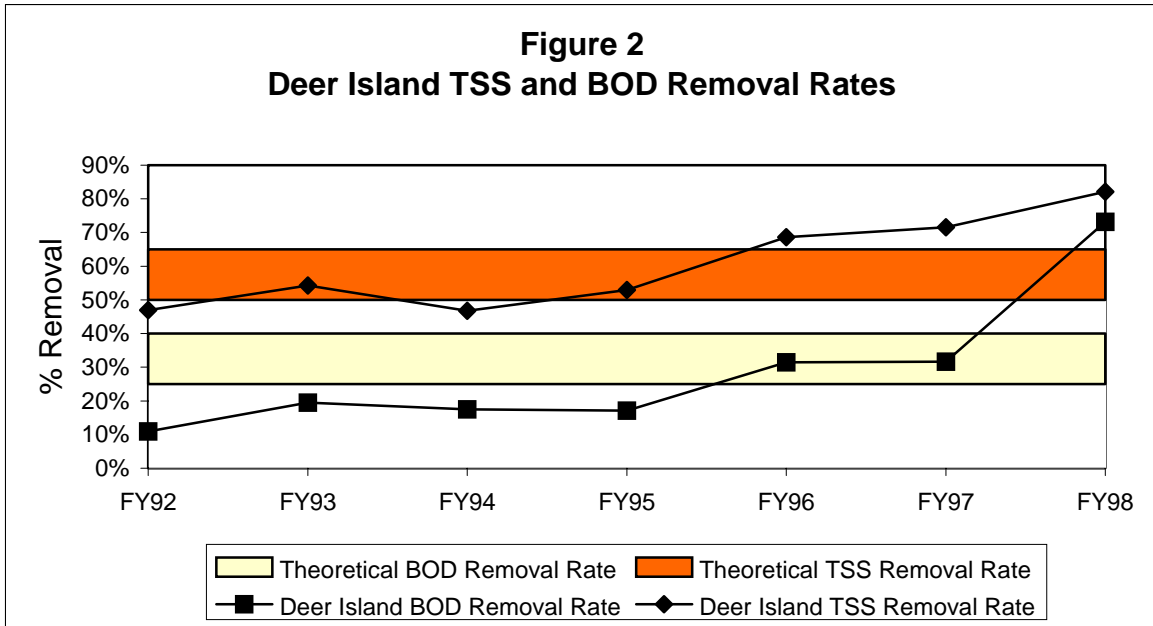

The impact of improved treatment at DITP can also be seen in the number of annual NPDES violations, which has decreased dramatically since the introduction of the new plant. Figure 3 compares the number of violations of the NPDES permit at Deer Island in FY98 to previous years. There was one non-toxicity NPDES violation in FY98 (and none in FY97), while there were 12 in FY96 and 19 in each of the previous two years. The non-toxicity violation in FY98 was an exceedance of the permitted daily BOD maximum. However, it is important to note that this violation occurred when the secondary battery was temporarily taken off line.³ There were 11 toxicity violations this year, but ten of them involved the red algae test, which the EPA plans to stop using in future permits due to the extreme sensitivity of the species. Some of the reduction in number of violations can be attributed to a change in testing methods for PHCs, but much of it has resulted from improved treatment.

³ The effluent violation occurred on November 6, 1997. The plant took down Secondary Battery A (to make modifications to the aeration system) during November 4-7.

Not included in Figure 3 are the pH violations during FY98. On 92 occasions, the pH fell below the minimum regulatory limit of 6.5. However, these violations can be qualified, since they are a direct result of approved treatment technologies. The new secondary treatment system, a pure oxygen system, lowers the pH as excess carbon dioxide (a result of biomass respiration) dissolves into the effluent. The new draft NPDES permit accounts for the expected lowered pH by expanding the pH limits to 6.0-9.0. The artificially lowered pH has no measurable impact on water quality, because of the buffering capacity of the receiving waters.

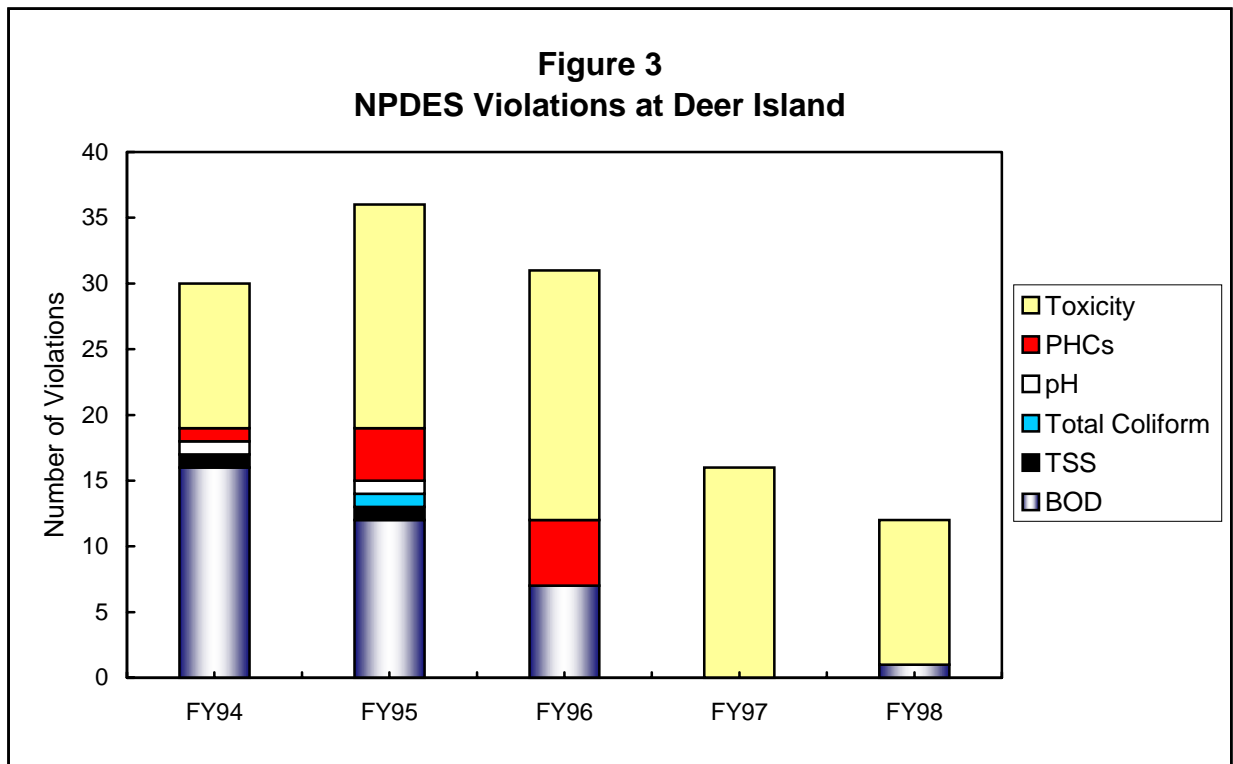

Deer Island also saw improvements in priority pollutant loadings. Decreases in influent metals loadings may be partly due to corrosion control activities. Some of the reduction in the effluent may also be caused by better capture of metals by the new plant. The only priority pollutants for which concentrations were high enough to exceed water quality standards, given the expected dilution of the effluent, were copper and cyanide.

Nut Island Treatment Plant

Removal efficiencies at the Nut Island Treatment Plant (NITP) were within the expected theoretical range for conventional parameters in FY98. As at Deer Island, copper and cyanide were the only priority pollutants with concentrations that were cause for concern.

As shown in Figure 4, NITP had 24 NPDES violations in FY98. Six of these involved low pH levels, two were violations of the daily maximum limit for PHCs, one was a BOD violation, one was a total coliform violation, and fourteen were toxicity violations. Ten of the fourteen toxicity violations were caused by the suspect red algae test.

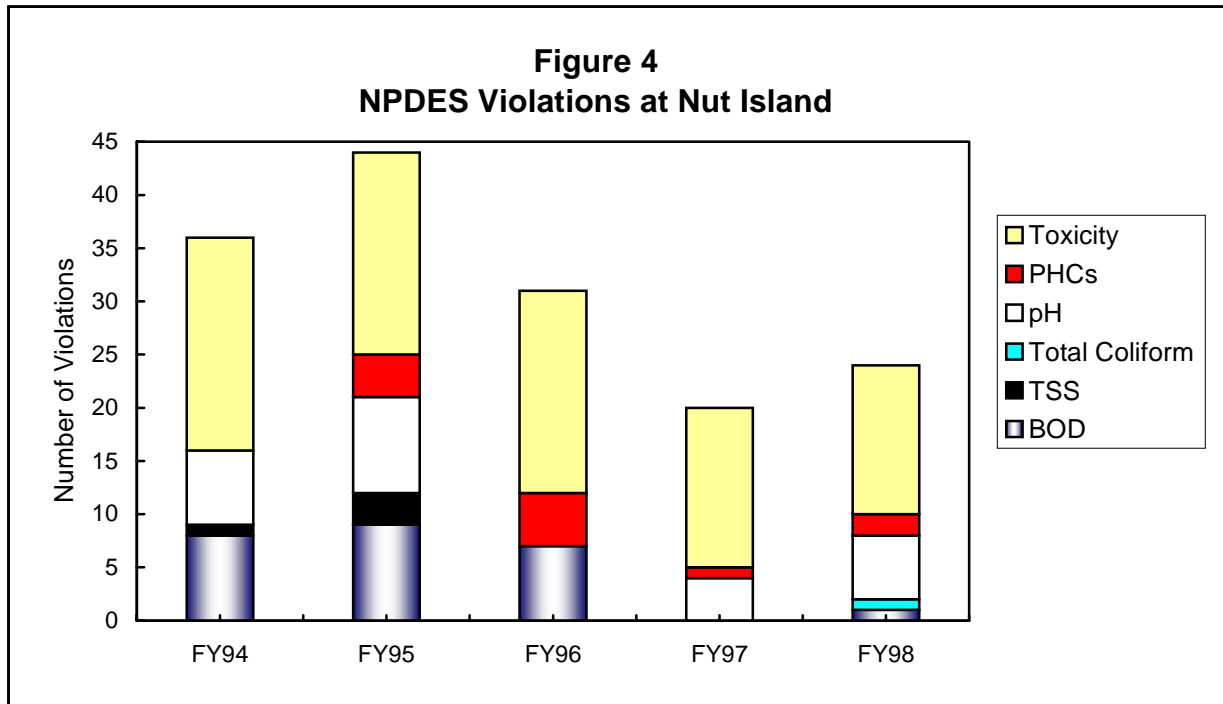

Combined Sewer Overflow Facilities

MWRA has three Combined Sewer Overflow (CSO) facilities – Cottage Farm, Prison Point and Somerville Marginal – which are required to be monitored under the existing NPDES permit. In addition, MWRA monitors three other CSO facilities, at Constitution Beach, Fox Point and Commercial Point, which are currently included in the Boston Water and Sewer Commission (BWSC) NPDES permit. MWRA’s new NPDES permit, which will be issued in FY99, will include all six CSO facilities.

Figures 5 and 6 show the number of activations as well as the total volume treated at the six CSO facilities over the past seven years. The correlation between rainfall and CSO activation can also be seen in Figures 5 and 6. Note that although total rainfall is correlated to CSO activation, the intensity of the rainfall will have an important effect, as will the frequency of the storms. These storm characteristics will influence the degree of ground saturation, which will affect the volume that is treated at the CSO facilities during a storm.

Figure 5
CSO Facility Activations, FY92-FY98

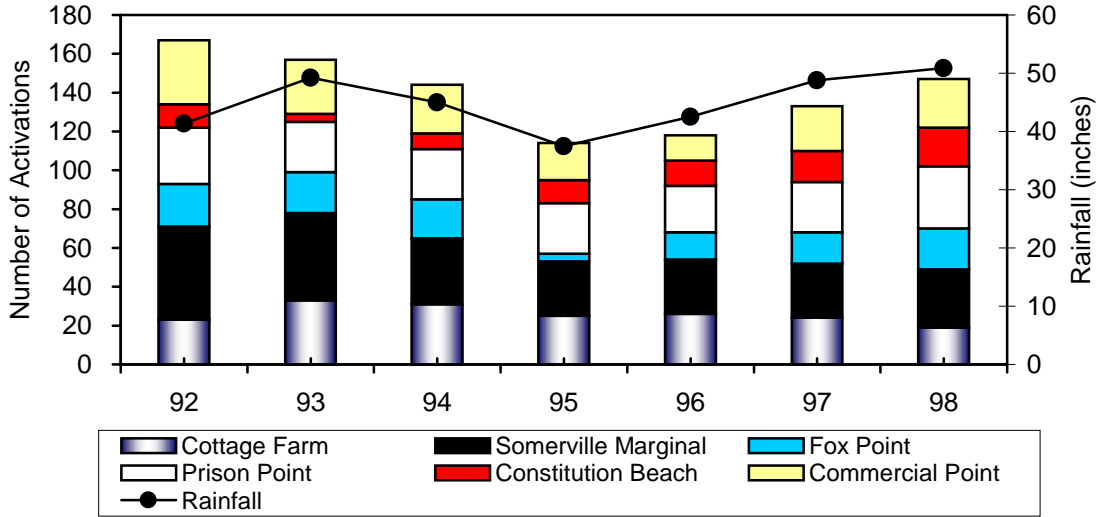
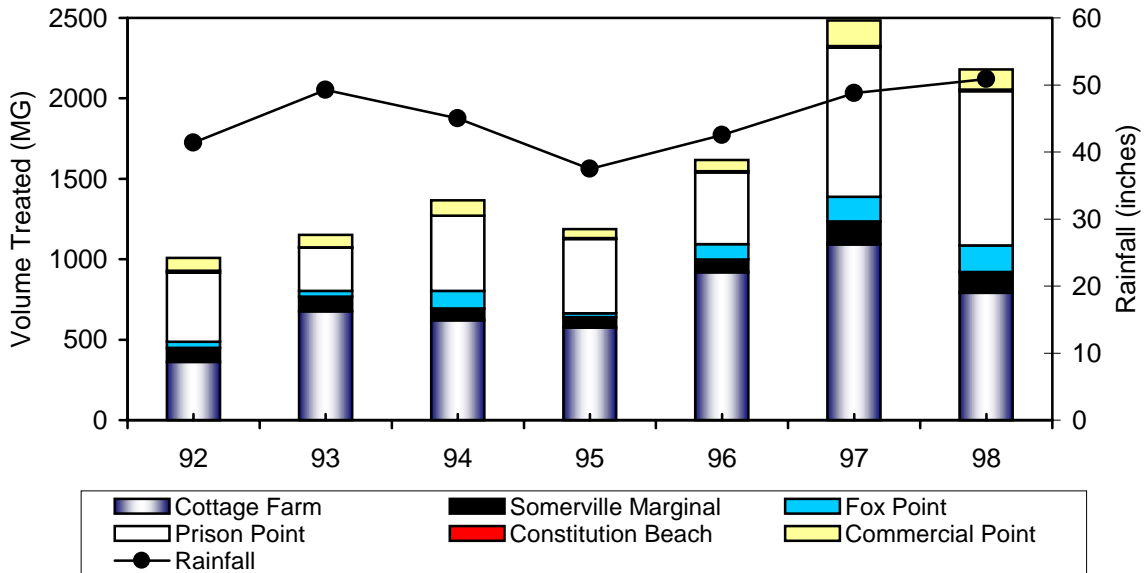
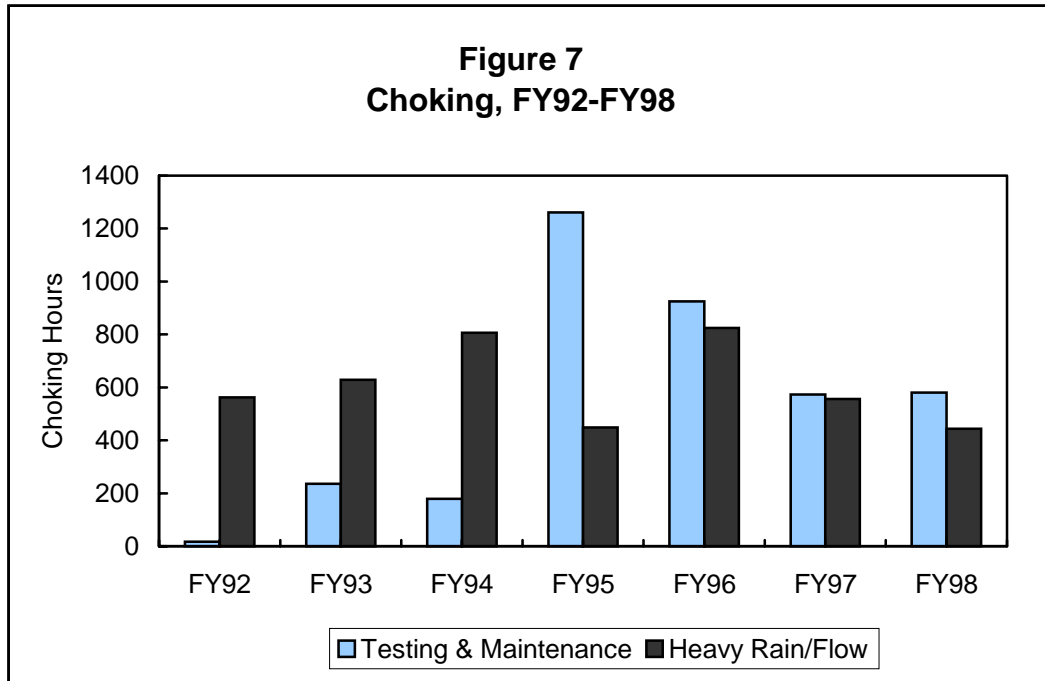

Figure 6
CSO Volume Treated, FY92-FY98



System Capacity

Some of the monitoring performed by MWRA relates to the capacity of the transport and treatment system. One of the system capacity parameters in the North System is choking, which occurs at the remote headworks. Choking is a reduction or stopping of flow to Deer Island, either when heavy flow exceeds the capacity of the treatment plant or when maintenance is performed on the plant.



As Figure 7 shows, the number of hours of choking changed little from FY98 to FY97. The majority of the testing- and maintenance-related choking was due to system testing of the new facilities, rather than maintenance purposes. Maintenance- and testing-related choking is performed at off-peak times and does not cause any backups in the system upstream.

Another system capacity parameter monitored by MWRA is the occurrence of Sanitary System Overflows, or SSOs. These overflows occur in areas where the collection system becomes overloaded by heavy flows. In FY95, the MWRA Transport Department started to locate and visually monitor these SSOs in the North and South Systems. Table 2 summarizes the SSOs observed by MWRA personnel in FY98.

Table 2 Sanitary Sewer Overflows, FY98	
Location	Number of Overflows
<i>North System</i>	
Section C Medford	2
Section 107 Medford	3
Section 91B Medford (Siphon)	0
Section 43.5 Medford	0
Section B Cambridge	1
Section 113 Winchester	1
Section 80 Arlington	1
<i>South System</i>	
Section 126 Weymouth Smelt Brook	8
Section 126 Weymouth (Manhole)	0
Section 128 Braintree (Siphon)	0

Future Outlook

The startup of the new primary treatment plant at Deer Island was just the first of several changes and improvements in MWRA's facilities. In FY98, secondary treatment was introduced at Deer Island. Currently, there are two batteries of secondary treatment, and a third battery is planned for FY00. In the beginning of FY99, the Nut Island facility will be decommissioned and South System flows will be transported to Deer Island for treatment at the new plant. The new outfall tunnel into Massachusetts Bay is expected to open in FY00. Once this tunnel is opened, DITP will no longer discharge effluent into Boston Harbor.

Effluent discharges from the new outfall tunnel will be regulated under a new NPDES permit. This comprehensive permit, the first of its kind, will include several new concepts. In addition to the usual monitoring, an ambient monitoring plan will be put into place for the new outfall site, as well as a contingency plan to ensure that discharge does not adversely impact Massachusetts Bay. Other requirements will include water conservation measures, pollution prevention plans, and best management practices to stop pollution before it reaches the treatment facility. A stepped-up industrial waste program will help industry meet local limits for pollutants. Intensified sampling at CSO facilities will better characterize the quality of CSO effluent. As MWRA completes its new facilities, the next challenge will be to implement these new programs and provide the Authority-wide coordination needed to meet the new NPDES reporting requirements.

I Introduction

This report presents and summarizes the National Pollutant Discharge Elimination System (NPDES) monitoring and compliance data compiled and analyzed by the Massachusetts Water Resources Authority (MWRA) NPDES Unit during the period of July 1997 to June 1998. MWRA's treatment plants and Combined Sewer Overflow (CSO) facilities serve large communities' needs for sewer systems while maintaining healthy water environments for recreation and wildlife.

The monitoring results for the new Deer Island Treatment Plant are presented and discussed in Chapter II and the results for the Nut Island Treatment Plant can be found in Chapter III. Chapter IV describes the results for the six Combined Sewer Overflow facilities. Chapter V discusses sewer system capacity. Appendices A-H provide detailed monthly data for the Deer Island and Nut Island plants, and for the six CSO facilities. Appendix I provides background information about MWRA's regulatory requirements, and Appendix J describes the MWRA sewer system and facilities. Appendix K defines the types of detection limits encountered in chemical analyses. Appendix L includes lists of pollutants of concern. Finally, Appendix M is a glossary of the terms and phrases used throughout this report.

II Deer Island Treatment Plant

This chapter presents and discusses monitoring information for the Deer Island Treatment Plant (DITP). The characteristics examined include flow, conventional parameters, nutrients, priority pollutants (metals, cyanide, pesticides/PCBs, and organic compounds), whole effluent toxicity, and bioaccumulation.

II.A Monitoring Results

II.A.1 Influent Characteristics

II.A.1.a Flow

The average flow to DITP in FY98 was 296 mgd. Figure II.A.1 shows that the amount of flow to the plant is influenced by precipitation. This occurs because several communities in the North System have combined sewers. Boston had record rainfall of 11.36 inches in June 1998. On June 13, 1998, the Deer Island Treatment Plant pumped a record 917.3 mgd (average daily flow).

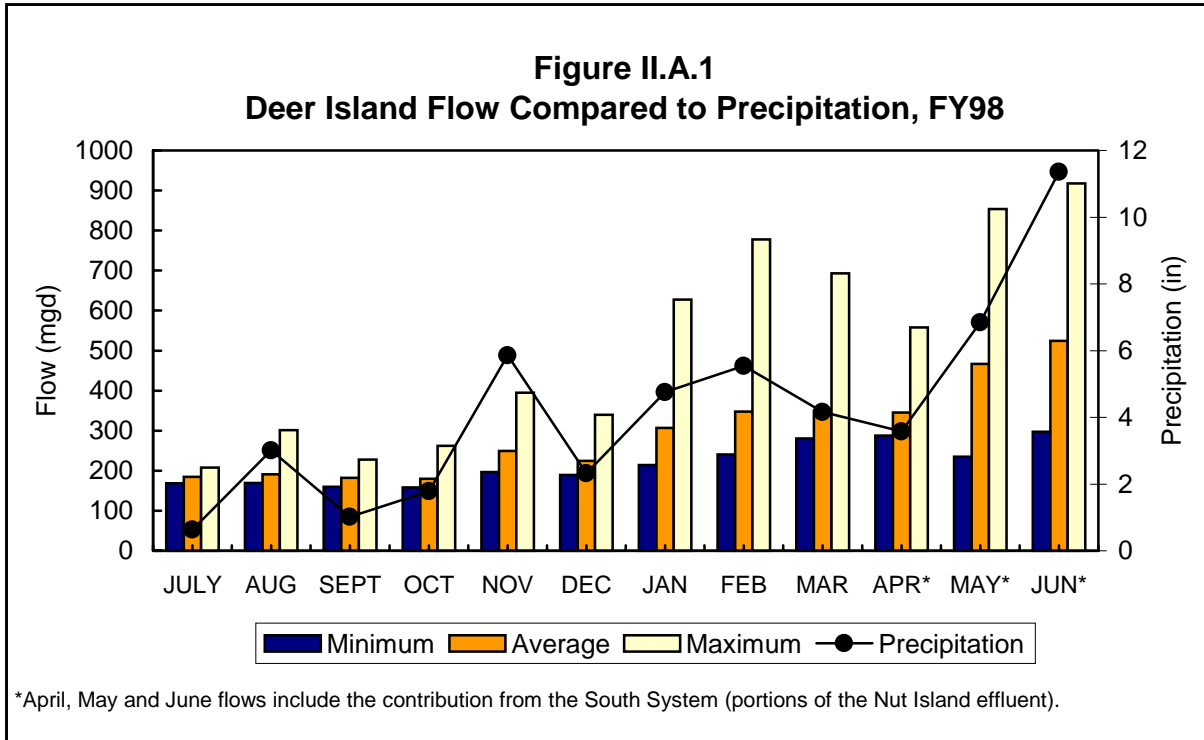

The impact of rainfall on flows can also be seen in Figure II.A.2, which tracks average flow and precipitation over the past 11 fiscal years. While yearly flows during this period have stayed essentially at the same level, they have followed the same general trend as the variations in yearly rainfall. Note that the FY98 average flow is influenced by the addition of some of the South System flow in April, May and June. During each of these months, an increasing portion of the Nut Island effluent was sent to DITP for treatment, to test the new South System Pump Station, located at Deer Island, and the Inter-Island Tunnel.

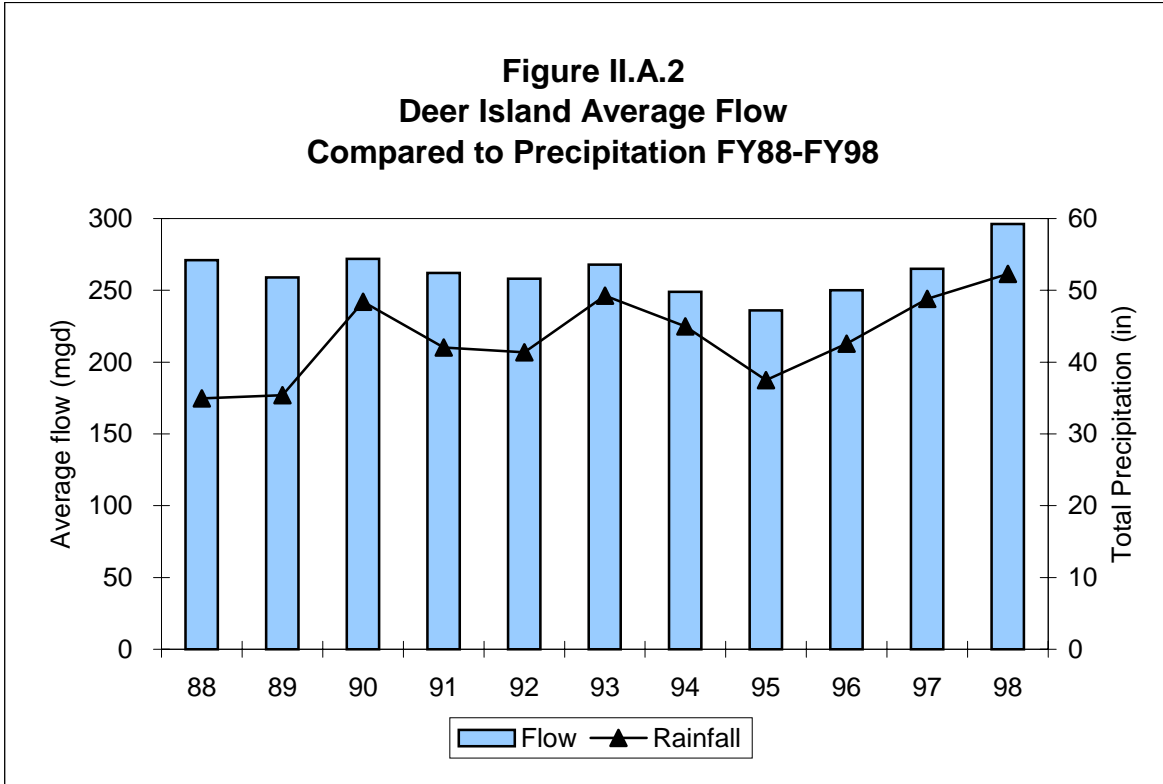
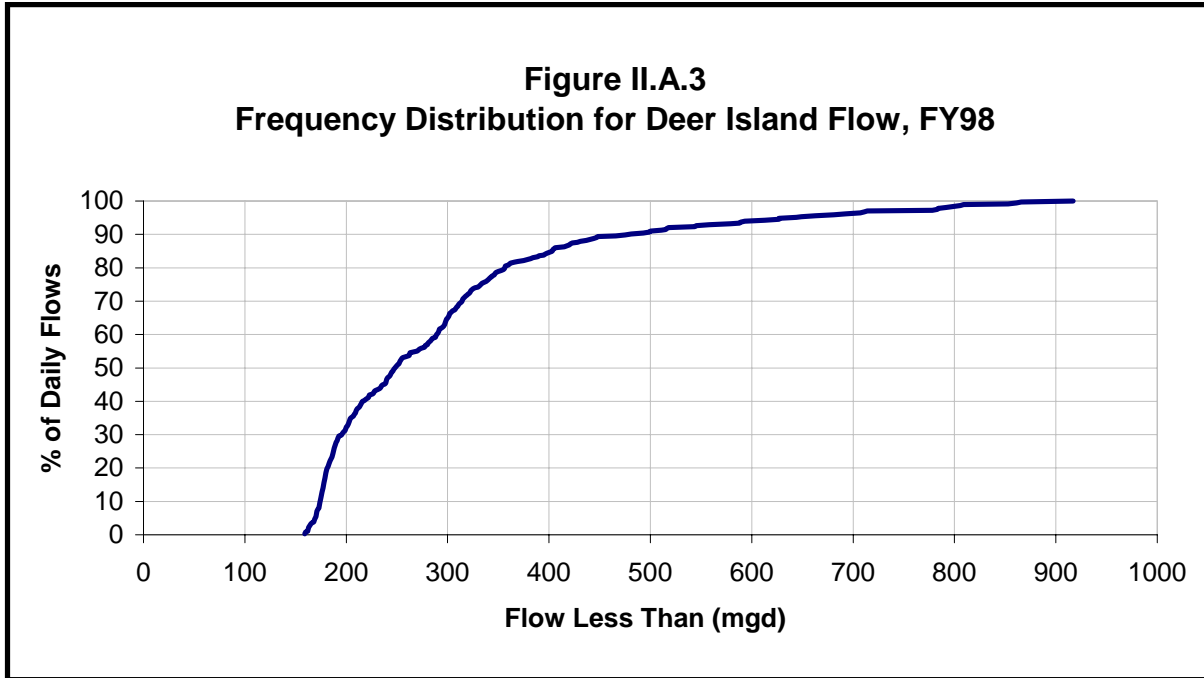

Figure II.A.3 provides a frequency distribution of DITP flow in FY98. Flow through the plant was less than 640 mgd 95% of the time. Again, note that the flows in April, May and June include a contribution from the South System.



II.A.1.b Conventional Parameters and Nutrients

As Table II.A.1 indicates, the FY98 Deer Island influent can be classified as weak/moderate.¹ A summary of conventional and nutrient concentrations and loadings in Deer Island influent from FY93-FY98 is provided in Table II.A.2.

Table II.A.1 Classification of Deer Island Influent (mg/L), FY98

<u>Parameter</u>	<u>Value</u>	<u>Weak</u>	<u>Medium</u>	<u>Strong</u>
TSS	141*	100	200	350
BOD	145*	100	200	300
TKN	26.4	20	40	85
Ammonia	14.5	12	25	50

*TSS and BOD concentrations include the contributions from the South System (i.e., Nut Island effluent) during the months of April, May and June, 1998.

¹Metcalf & Eddy, Inc. 1972. Wastewater Engineering: Collection, Treatment, Disposal. New York: McGraw-Hill Book Company, p. 231.

Table II.A.2 Deer Island Influent Characterization, FY93-FY98

PARAMETER	FY93	FY94	FY95	FY96	FY97	FY98
Flow (mgd)*						
Minimum	174	171	167	147	167	159
Average	266	249	236	250	265	296
Maximum	628	528	565	526	649	917
Total Suspended Solids (TSS)*						
Min Conc (mg/L)	121	93	102	56	50	32
Avg Conc (mg/L)	153	137	138	140	144	141
Max Conc (mg/L)	193	175	160	432	284	382
Average Loading (tons/d)	170	142	136	146	159	175
Biochemical Oxygen Demand (BOD)*						
Min Conc (mg/L)	123	99	99	61	39	31
Avg Conc (mg/L)	159	149	140	143	136	145
Max Conc (mg/L)	190	175	173	246	311	302
Average Loading (tons/d)	176	155	138	149	151	179
Settleable Solids						
Min Conc (mL/L)	1.4	1.9	3.5	0.1	1.5	0.1
Avg Conc (mL/L)	3.7	3.9	5.6	7.0	6.9	6.3
Max Conc (mL/L)	5.0	5.6	7.3	18.0	17.0	20
Average Loading (tons/d)	4.1	4.0	5.5	7.3	7.7	7.8
Oil and Grease						
Min Conc (mg/L)	20	14	17	10	12	7
Avg Conc (mg/L)	43	36	31	34	29	30
Max Conc (mg/L)	84	64	37	67	136	108
Average Loading (tons/d)	48	37	31	35	33	36
Total Kjeldahl Nitrogen						
Min Conc (mg/L)	13.9	11.2	14.0	11.6	8.7	13.6
Avg Conc (mg/L)	26.9	21.9	21.9	26.3	24.2	26.4
Max Conc (mg/L)	44.7	29.3	29.1	56.3	48.1	37.7
Average Loading (tons/d)	29.8	22.7	21.5	27.4	26.8	32.6

Table II.A.2 Deer Island Influent Characterization, FY93-FY98 [cont.]

PARAMETER	FY93	FY94	FY95	FY96	FY97	FY98
Ammonia-Nitrogen						
Min Conc (mg/L)	6.8	5.6	7.3	6.8	2.5	4.8
Avg Conc (mg/L)	13.4	12.3	13.7	15.0	13.3	14.5
Max Conc (mg/L)	17.9	17.9	18.0	24.0	18.6	23.1
Average Loading (tons/d)	14.9	12.8	13.5	15.6	14.6	17.8
Nitrates						
Min Conc (mg/L)	0.13	0.10	0.02	0.01	0.01	0.01
Avg Conc (mg/L)	0.70	0.80	0.15	0.14	0.22	0.36
Max Conc (mg/L)	2.15	2.70	0.59	1.42	2.31	1.95
Average Loading (tons/d)	0.78	0.83	0.15	0.15	0.24	0.44
Nitrites						
Min Conc (mg/L)	0.02	0.00	0.02	0.01	0.01	0.01
Avg Conc (mg/L)	0.06	0.10	0.06	0.07	0.09	0.08
Max Conc (mg/L)	0.13	0.20	0.19	1.66	0.35	0.46
Average Loading (tons/d)	0.07	0.10	0.06	0.07	0.10	0.10
Orthophosphorus						
Min Conc (mg/L)	2.04	0.40	1.00	0.29	0.13	0.49
Avg Conc (mg/L)	2.04	2.30	2.20	1.53	1.49	1.76
Max Conc (mg/L)	2.04	5.10	5.66	3.19	2.62	3.13
Average Loading (tons/d)	2.26	2.39	2.17	1.60	1.64	2.17
Total Phosphorus						
Min Conc (mg/L)	2.63	0.60	2.11	1.54	1.21	1.80
Avg Conc (mg/L)	6.04	4.00	3.63	3.42	3.19	3.70
Max Conc (mg/L)	9.07	8.30	4.79	4.85	5.00	5.29
Average Loading (tons/d)	6.70	4.15	3.57	3.57	3.53	4.57

*FY98 data for flow, TSS, and BOD reflect the contribution from both the North System and the South System (Nut Island effluent) during the months of April, May and June. (Flow is the sum of the North and South System flows, and TSS and BOD are the flow weighted averages reported in the monthly Operations summary report.) For all other constituents, the concentrations in the table are from the North System influent.

II.A.1.c Priority Pollutants

The results of a complete priority pollutant scan of Deer Island influent can be found in Table A-2 (concentrations) and Table A-3 (loadings) of Appendix A. For levels below detection limits, one half of the method detection limit for inorganics, and one tenth of the quantitation limit for organics was substituted. A discussion of detection and quantitation limits can be found in Appendix K.

FY98 influent average loadings for several key metals are compared to historical values in Figure II.A.4. Metals loadings have decreased over the past several years. Causes for the decrease include toxics control measures and corrosion control efforts involving both water supply and wastewater transport.

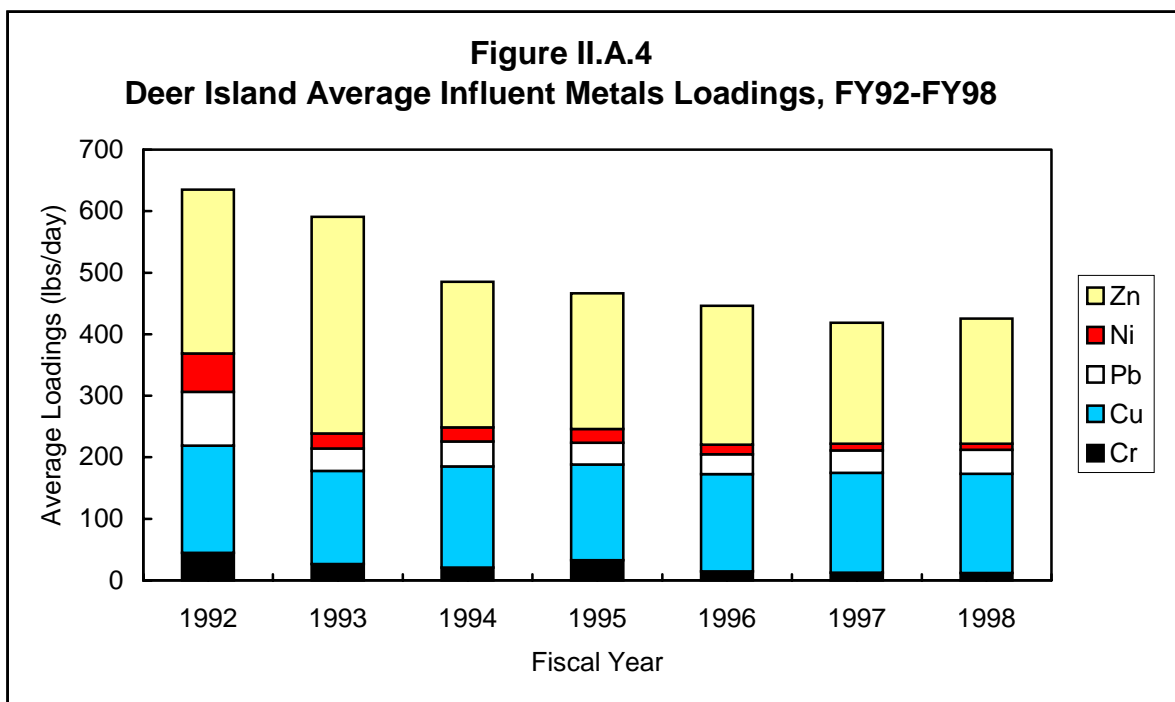
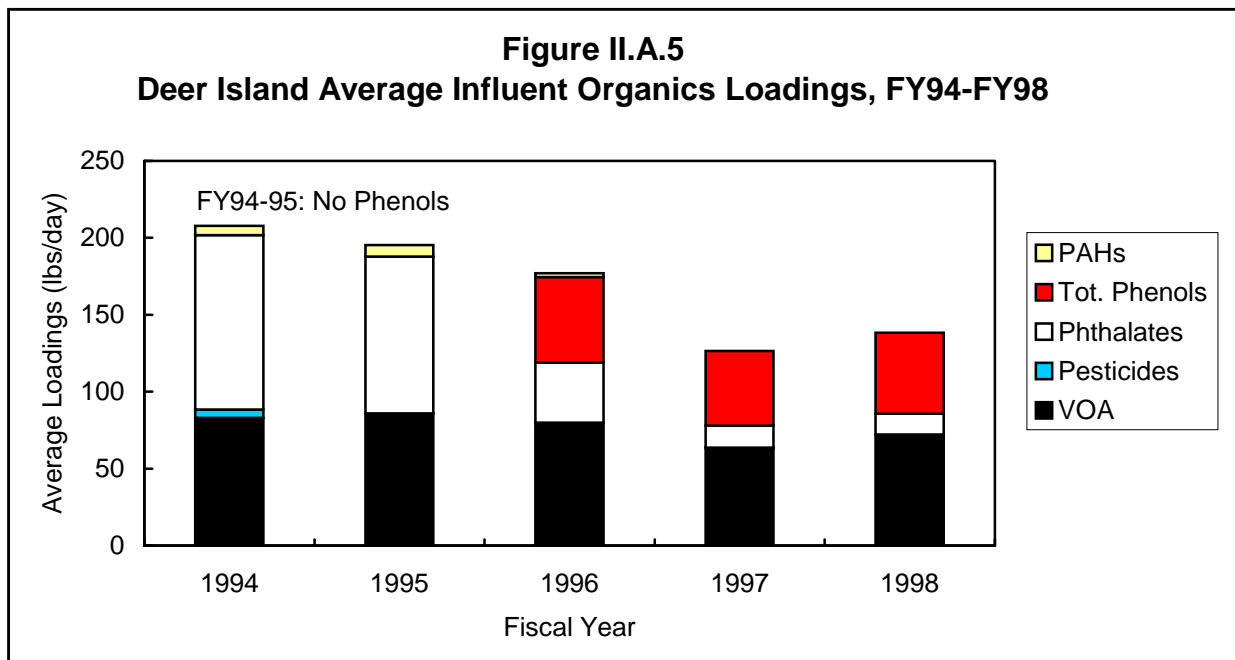

Figure II.A.5 compares influent loadings of certain representative organic priority pollutants to the loadings in previous years. (See Table A-3 in Appendix A for more details.) Samples of these pollutants are taken a few times a month. The daily load can then be calculated from the measured concentration and the flow on the day during which the sample was taken.

Figure II.A.5 shows the annual average of the daily loads (lbs/day) for the past five fiscal years. The figure includes the average loads of those pollutants that were detected at least once. However, it does not reflect how often the pollutant was detected during the year. Therefore, for example, if in FY98 a pollutant were detected twice out of 35 tests, the pollutant's average daily loading for the year would be included in the chart below. If in FY97 that same pollutant were detected 34 out of 35 times, the average loading would be included in the chart below, without differentiating it from FY98. Moreover, the average loading of a pollutant may be artificially high, since when the pollutant is not detected, one tenth of the reporting limit is listed (see Appendix K). Therefore, when this concentration is converted to load, the load is recorded as a non-zero value, even though the constituent may have not been present in the sample at all.



II.A.2 Effluent Characteristics

Secondary treatment was initiated during the second full week of July 1997. After that, flows through secondary treatment were slowly increased. Secondary treatment capacity continued to expand in August 1997 until the plant reached normal operating capacity for Secondary Battery A (180 mgd). In the second half of FY98, another battery of secondary treatment, Battery B, came on-line. By mid-March 1998, two batteries of treatment were running. The introduction of secondary treatment to the Deer Island Treatment Plant has an effect on removal efficiencies, as described in Section II.A.2.a below.

II.A.2.a Conventional Parameters

Table II.A.3 compares DITP's removal efficiencies for TSS and BOD with theoretical removal efficiencies.²

<u>Parameter</u>	<u>DITP Removal Efficiency*</u>	<u>Theoretical Removal Efficiency</u>	
		<u>Primary Treatment</u>	<u>Secondary Treatment</u>
TSS	82%	50-65%	85%
BOD	73%	25-40%	85%

*Removal efficiencies were determined using the average influent and effluent concentration values as reported in Table A-1, Appendix A. Note that a portion of the flow each month went through secondary treatment. See Table II.A.4 for more information.

Table II.A.4 shows how the TSS and BOD removal efficiencies may be affected by the degree of secondary treatment. The table lists, on a month-by-month basis, the TSS and BOD removal efficiencies, and the percentage of plant flow that received secondary treatment. The removal efficiencies are determined from the average effluent and influent concentrations for TSS and BOD, as reported in Table A-1 of Appendix A. The degree of secondary treatment is the average flow

²Metcalf & Eddy, Inc. 1972. Wastewater Engineering Collection, Treatment, Disposal. New York. McGraw-Hill Book Company, p. 446.

through secondary treatment (mgd) during the month, divided by the average plant flow (mgd) for that month.

In April, when both batteries of secondary treatment were on-line, an average of 92% of DITP flow went through secondary treatment, and removal efficiencies were at their highest levels for the year. In May and June, flows to Deer Island were unusually high due to the introduction of Nut Island flows and increased precipitation; therefore, a lower percentage of flow could be sent to secondary treatment, resulting in reduced removal efficiencies. In addition, the more dilute influent in May and June meant that the biological processes of secondary treatment could not proceed as efficiently.

	TSS Removal Efficiency	BOD Removal Efficiency	% of Flow Treated at Secondary Levels
July	76%	50%	N/A
August	82%	72%	62%
September	83%	77%	73%
October	89%	83%	81%
November	74%	67%	59%
December	81%	78%	73%
January	79%	70%	51%
February	78%	69%	50%
March	79%	77%	72%
April	91%	85%	92%
May	89%	81%	67%
June	83%	75%	65%

Table II.A.5 summarizes the conventional parameters and nutrients in Deer Island effluent over the past six years. The significant drop in several parameters that occurred between FY95 and FY96 is due to the improved removal efficiency of the new primary treatment plant. The introduction of secondary treatment in FY98 can explain the drop in TSS and BOD concentrations from FY97 to FY98. It can also explain the increase in ammonia, nitrates and nitrites. Oil and grease showed a significant decrease from FY97 to FY98.

Table II.A.5 Deer Island Effluent Characterization, FY93-FY98

PARAMETER	FY93	FY94	FY95	FY96	FY97	FY98
Flow (mgd)						
Minimum	174	171	167	147	167	159
Average	266	249	236	250	265	296
Maximum	628	528	565	526	649	917
Total Suspended Solids (TSS)						
Min Conc (mg/L)	58	65	52	17	16	4
Avg Conc (mg/L)	70	73	65	44	41	25
Max Conc (mg/L)	77	86	90	136	100	140
Average Loading (tons/d)	78	76	64	46	46	31
Biochemical Oxygen Demand (BOD)						
Min Conc (mg/L)	89	87	85	42	29	8
Avg Conc (mg/L)	128	123	116	98	93	39
Max Conc (mg/L)	152	142	138	147	191	216
Average Loading (tons/d)	142	128	114	102	103	48
Settleable Solids						
Min Conc (mL/L)	0.1	0.1	0.1	0.1	0.1	0.1
Avg Conc (mL/L)	0.3	0.5	0.4	0.2	0.2	0.2
Max Conc (mL/L)	0.5	0.9	0.7	2.0	1.6	7.0
Average Loading (tons/d)	3.3	0.5	0.4	0.2	0.2	0.2
Oil and Grease						
Min Conc (mg/L)	15	12	17	7	7	4
Avg Conc (mg/L)	27	25	25	24	23	11
Max Conc (mg/L)	37	36	30	42	47	30
Average Loading (tons/d)	30	26	25	25	26	13
Total Kjeldahl Nitrogen						
Min Conc (mg/L)	14.9	12.8	13.7	10.6	10.9	9.1
Avg Conc (mg/L)	22.2	21.7	23.0	22.5	21.9	20.4
Max Conc (mg/L)	26.2	32.8	28.6	32.5	27.6	32.4
Average Loading (tons/d)	24.6	22.5	22.6	23.4	24.3	25.2

Table II.A.5 Deer Island Effluent Characterization, FY93-FY98 [cont.]

PARAMETER	FY93	FY94	FY95	FY96	FY97	FY98
Ammonia-Nitrogen						
Min Conc (mg/L)	7.59	6.08	7.28	5.55	4.43	3.48
Avg Conc (mg/L)	12.35	12.58	14.43	14.48	13.07	15.08
Max Conc (mg/L)	15.70	18.51	19.60	21.90	18.00	22.70
Average Loading (tons/d)	13.70	13.06	14.20	15.10	14.45	14.45
Nitrates						
Min Conc (mg/L)	0.05	0.13	0.03	0.01	0.01	0.01
Avg Conc (mg/L)	0.66	1.04	0.08	0.30	0.34	0.42
Max Conc (mg/L)	1.63	5.98	0.28	1.95	2.58	1.49
Average Loading (tons/d)	0.73	1.08	0.08	0.31	0.37	0.52
Nitrites						
Min Conc (mg/L)	0.02	0.01	0.02	0.01	0.01	0.01
Avg Conc (mg/L)	0.16	0.10	0.08	0.63	0.11	0.20
Max Conc (mg/L)	0.48	0.26	0.22	1.90	0.62	1.15
Average Loading (tons/d)	0.18	0.10	0.08	0.66	0.12	0.25
Orthophosphorus						
Min Conc (mg/L)	0.98	0.48	0.90	0.37	0.48	0.48
Avg Conc (mg/L)	2.27	2.15	2.22	1.71	1.68	1.71
Max Conc (mg/L)	3.59	4.09	3.39	3.01	2.71	3.18
Average Loading (tons/d)	2.52	2.23	2.18	1.78	1.85	2.11
Total Phosphorus						
Min Conc (mg/L)	2.03	1.19	2.11	1.43	1.12	1.17
Avg Conc (mg/L)	3.64	2.92	3.35	2.92	2.94	2.77
Max Conc (mg/L)	4.71	5.18	4.35	4.13	3.98	7.74
Average Loading (tons/d)	4.04	3.03	3.30	3.04	3.24	3.42

II.A.2.b Nutrients

A summary of nutrient concentrations in Deer Island effluent from FY93-FY98 is provided in Figure II.A.6. There have not been any major changes in nutrient concentrations over the past several years. The introduction of the new primary treatment plant in FY95 did not affect nutrient concentrations, because primary treatment does not remove nutrients. The introduction of secondary treatment in FY98 might contribute to an increase of nutrients in the effluent.

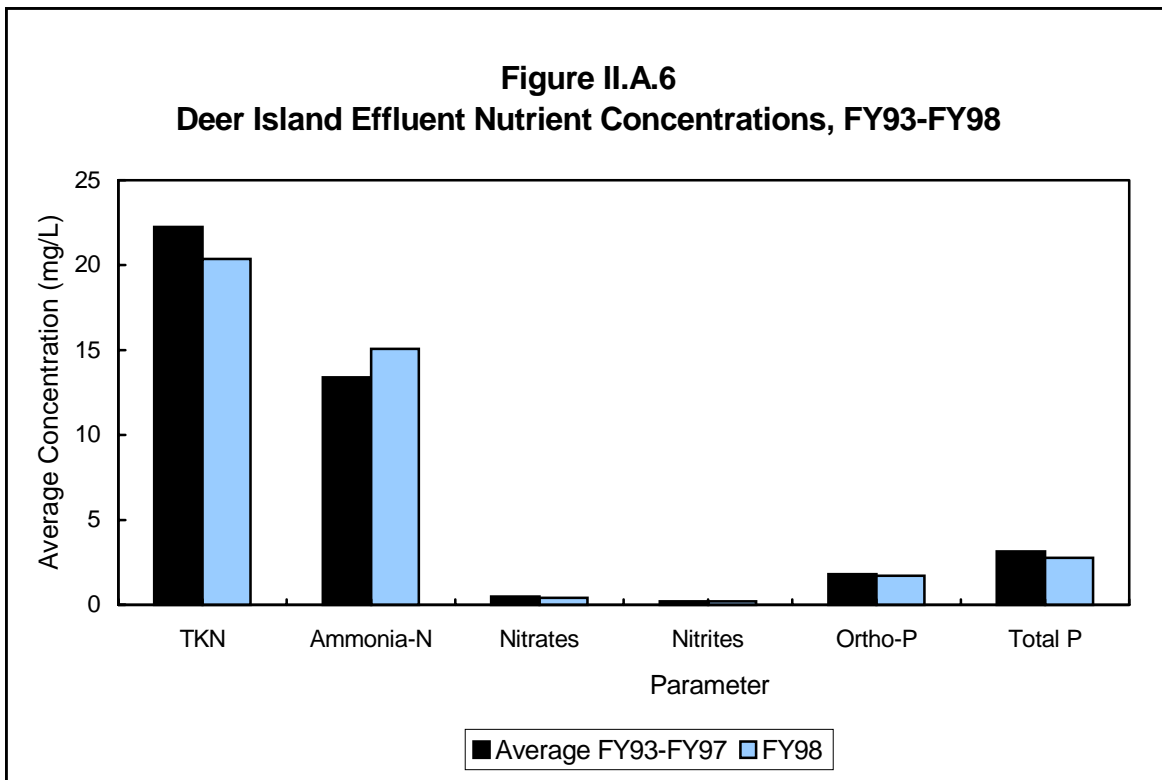

II.A.2.c Priority Pollutants

A summary of priority pollutant concentrations and loadings in DITP effluent for FY98 is provided in Appendix A, Tables A-4 and A-5. Metals loadings over the past ten years are summarized in Figure II.A.7, while organic pollutants from FY94-FY98 are graphed in Figure II.A.8. (See Section II.A.1.c for a discussion of the organics loading data.) As can be expected with primary treatment, generally the same metals and other priority pollutants were detected in the effluent as were found

in the influent. The gradual decrease in loadings over the past few years reflects the decrease in loadings in the influent during the same time period.

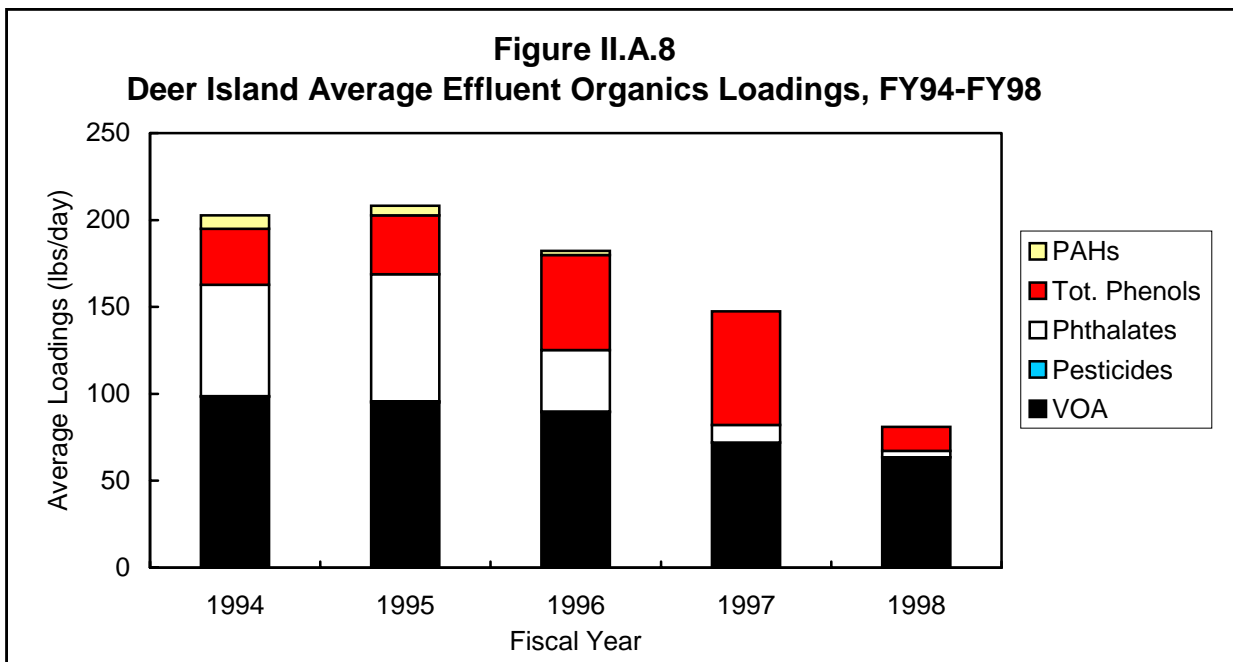
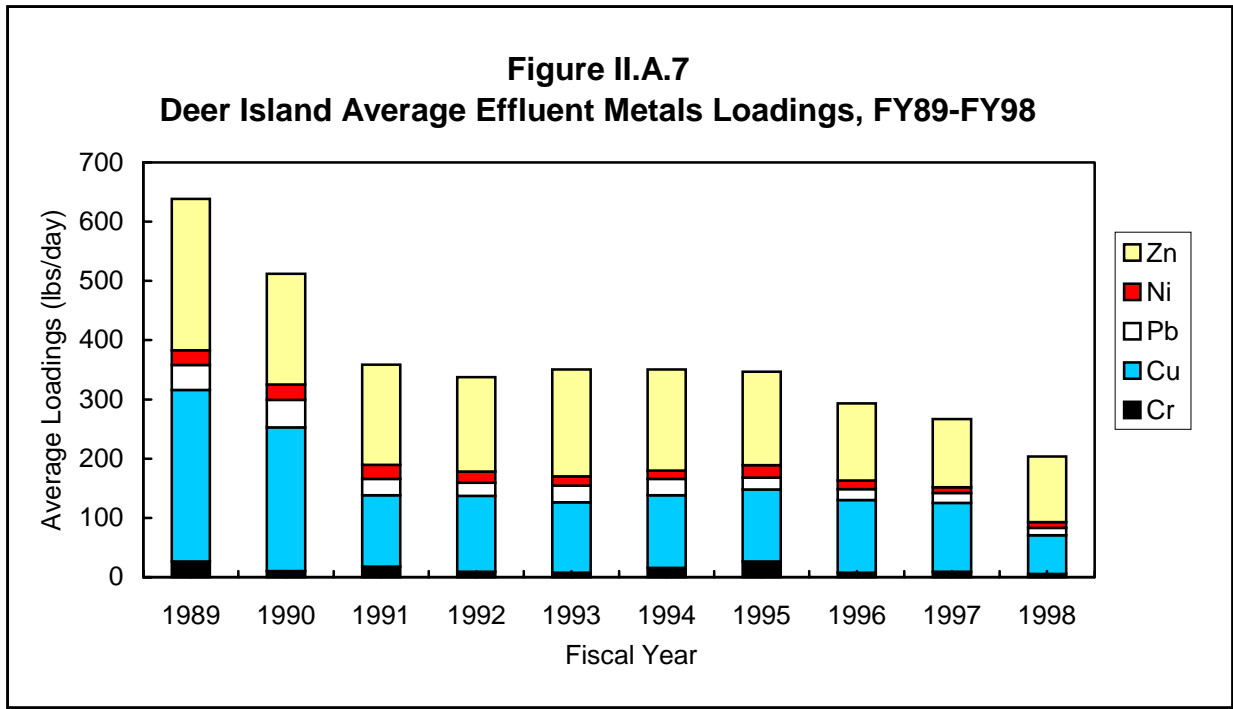

II.A.2.d Whole Effluent Toxicity

MWRA tests effluent toxicity every month at the Deer Island and Nut Island Treatment Plants. Effluent toxicity provides an overall view of the quality of the effluent, to ensure that the effluent does not adversely affect the environment. In 1989, the EPA found that the probable cause of most acute toxicity in DITP's wastestream was due to surfactants. Surfactants are most commonly used in household detergents to improve cleansing power. No acute toxicity could be attributed to metals or pesticides.

MWRA is required to use three tests for effluent toxicity. An acute static toxicity test using mysid shrimp (*Mysidopsis bahia*) measures the short term lethal effects caused by the effluent. A chronic survival and growth test using the sheepshead minnow (*Cyprinodon variegatus*) and a chronic reproduction test using a red algae (*Champia parvula*) both measure subtle toxic impacts over a longer period of time. The results of these tests can be found in Table II.A.6.

The LC50 (Lethal Concentration 50%) is the concentration of effluent in a sample that causes mortality to 50% of the test population at a specific time of observation. The NOEC (No Observed Effect Concentration) is the concentration of effluent in a sample to which organisms are exposed in a life cycle or partial life cycle test which has no adverse effects. An NOEC limit of 20% means that 20% of the sample contains effluent, and the remainder is dilution water. Any NOEC below 20% would violate the limit.

Reductions in toxicity at DITP in FY98 reflect the benefits of secondary treatment. The results for the sheepshead minnow test were in compliance 92% of the time, and the mysid acute test was in compliance 100% of the time. The results of the red algae test were never in compliance. Due to questions regarding the sensitivity and reliability of the red algae test, Region I EPA is withdrawing red algae as a test species in future permits. See Section III.A.2.d for Nut Island Treatment Plant effluent toxicity results.

**Table II.A.6
Deer Island Effluent, Results of Toxicity Testing, FY98**

	<u>Mysid Shrimp acute</u>		<u>Sheepshead Minnow chronic</u>		<u>Red Algae chronic</u>
	LC50	NOEC	Survival NOEC	Growth NOEC	NOEC
Limits (%)	None	20	10	10	10
July	67	20	10	5	0.7
August	79	50	60	60	<0.2
September	42	50	100	60	<0.2
October	>100	100	60	10	0.7
November	31	20	40	40	*
December	>100	20	60	60	0.7
January	>100	100	100	20	7.0
February	>100	100	100	60	*
March	>100	50	100	100	0.2
April	>100	100	100	60	0.2
May	33	20	100	60	2.0
June	37	20	60	60	0.2
FY98 Average	>74	54	74	50	<1.2
# of Violations		0	0	1	10

*Test invalid due to failure of controls to meet acceptability requirements.

II.A.2.e Bioaccumulation

Bioaccumulation studies measure the potential for long-term buildup of pollutants in aquatic species. In the summer of 1997, MWRA conducted a mussel bioaccumulation study for DITP effluent designed to be comparable to studies conducted in 1987 and from 1991 to 1996. The results of this study can be found in Table II.A.7 (lead and mercury) and Table II.A.8 (other contaminants).

Mussels were collected in Gloucester (Sandwich for the mercury and lead analyses) and deployed at the Deer Island effluent discharge, at the proposed offshore discharge site in Massachusetts Bay (for pre-discharge baseline data), and at the New England Aquarium in Boston's Inner Harbor (dirty control). At the start of the study, tissue from the Gloucester mussels was analyzed for PAHs, PCBs and organochlorine pesticides. Sandwich mussels were analyzed for mercury and lead. After 60 days,

mussels deployed at Deer Island showed significant bioaccumulation of High Molecular Weight PAHs, PCBs, dieldrin, alpha-chlordane, trans-nonachlor and lead. Only Low Molecular Weight PAHs, which make up 90% of the PAHs in the Deer Island discharge, have shown a clear decrease since 1987 and are now the same as background levels. As in earlier years, mussels deployed at the Aquarium had body burdens of contaminants that were equivalent to or greater than those at Deer Island.

Table II.A.7 Concentrations of Metals Bioaccumulating in Boston Harbor Mussels

	Pre- Deployment*	Clean Control*	Dirty Control*	Deer Island	Nut Island
Lead (ug/g)					
1987	2.8	3.1		6.7**	8.3**
1991	6.5	5	6.4	5.9	
1993	5.1	3.7**		5.9	
1994	8.6	4.8**	6.7	9.1	
1995	6.1	DL	8.5**	8	
1996	2.9	1.6	9.4**	6.3**	
1997	2.4	2.1	9.9**	7.8**	
Mercury (ug/g)					
1993	0.39	0.10**		0.18**	
1994	0.26	0.13	0.16	0.21	
1995	0.064	DL	0.068	0.056	
1996	0.13	0.15	0.13	0.15	
1997	0.17	0.10	0.32	0.06**	

* Mussels collected from Cape Cod in 1987 and 1995 to 1997, and Gloucester in 1991 to 1994.

Clean control at proposed offshore discharge in 1987, 1992 to 1997 and in Gloucester in 1991.

Dirty control at New England Aquarium.

All deployments were for 60 days except 1995, which was for 50 days.

** Statistically different ($p < 0.05$) from pre-deployment.

DL = Deployments lost due to entanglement with fishing gear.

Table II.A.8 Concentrations of Contaminants Bioaccumulating in Boston Harbor Mussels

	Pre-Deployment*	Clean Control*	Dirty Control*	Deer Island	Nut Island
Total PCBs (ng/g)					
1987	317	227		630**	604**
1991	77	77	477**	199**	
1992	65	44**	652**	133**	
1993	AP	110	596**	321**	
1994	107	89	500**	161**	
1995	94	DL	441**	172**	
1996	160	102	538**	273**	
1997	136	101	785**	360**	
Total DDTs (ng/g)					
1987	52	30		63	51
1991	28	28	94**	48**	
1992	15	12	103**	25**	
1993	AP	30	130**	63**	
1994	27	19	86**	50**	
1995	29	DL	92**	45**	
1996	58	30	119**	85**	
1997	53	23**	136**	61	
Alpha - Chlordane (ng/g)					
1987	8.7	6.7		21.5**	19.5**
1991	2.4	2.5	19.0**	10.3**	
1992	1.9	1.7	19.0**	6.9**	
1993	2.9	3.8	10.5**	8.2**	
1994	3.5	3.6	12.8**	13.8**	
1995	2.6	DL	11.7**	7.5**	
1996	4.8	3	15.8**	20.0**	
1997	4.4	2.9**	14.0**	10.4**	
Dieldrin (ng/g)					
1987	6.6	3.6		11.4	7.6
1991	<1.4	2.3	9.0**	2.9	
1992	<1.0	1.2	6.7**	2.7	
1993	<2.9	2.2	4.5**	34	
1994	<1.2	2	15.6**	10.4**	
1995	1.5	DL	6.9**	3.2**	
1996	0.5	1.7	9.3**	5.6**	
1997	2.3	2.0	7.1**	3.4**	
Lindane (ng/g)					
1987	1.8	0.8		5.5	0.8
1991	<1.5	<2.2	<3.2	<2.5	
1992	<1.0	<1.0	<1.9	<1.3	
1993	AP	<1.7	2.3	2.7	
1994	<.9	<0.6	<2.2	1.6	
1995	0.7	DL	1.3	1	
1996	0.3	0.6	0.3	0.3	
1997	0.4	0.4	0.4	0.4	

Table II.A.8 Concentrations of Contaminants Bioaccumulating in Boston Harbor Mussels [cont.]

	Pre-Deployment*	Clean Control*	Dirty Control*	Deer Island	Nut Island
Trans-Nonachlor (ng/g)					
1987	7.7	6.2		18.0**	
1991	<1.4	<1.5	<2.5	8.9**	
1992	2.1	2.5	21.3**	8.3**	
1993	4.8	4.0	11.0**	10.7**	
1994	4.0	3.8	11.0**	11.2**	
1995	0.6	DL	9.0**	4.2**	
1996	5	4.0	13.8**	17.0**	
1997	4.4	3.2	14.6**	9.4**	
Total PAHs (ng/g)					
1987	581	465		2344**	683
1991	217	228	2570**	1207**	
1992	216	129**	3545**	1934**	
1993	188	166	1321**	665**	
1994	264	122	2255**	848**	
1995	214	DL	1444**	761**	
1996	402	142**	2500**	1230**	
1997	157	86**	1493**	346**	
LMW PAHs (ng/g)					
1987				1221	
1991	113	74	239**	516**	
1992	80	61	199**	427**	
1993	66	66	110	169**	
1994	106	61	79	217**	
1995	105	DL	206**	340**	
1996	195	70	268	431**	
1997	68	58	148**	85	
HMW PAHs (ng/g)					
1987				1123	
1991	104	154	2330**	691**	
1992	136	69	3347**	1507**	
1993	122	101	1210**	496**	
1994	158	61	2174**	631**	
1995	109	DL	1238**	421**	
1996	207	70	2233**	799**	
1997	89	28**	1345**	261**	

Hexachlorobenzene, heptachlor, aldrin, heptachlor epoxide, and mirex not detected or detected near detection limit at all stations.

* Mussels collected from Cape Cod in 1987 and Gloucester in 1991 to 1997.

Clean control at proposed offshore discharge in 1987, 1992 to 1997 and in Gloucester in 1991.

Dirty control at New England Aquarium.

In 1987 mussels deployed for 30 days; in 1992-94 and 1996-97 for 60 days and in 1995 for 50 days

** Statistically different (p<0.05) from pre-deployment

DL = Deployment lost due to entanglement with fishing gear

AP = Analytical Problems - No Data

II.B Discussion

II.B.1 Compliance with Regulatory Limits

MWRA currently operates under a court order which provides interim discharge limits for the existing Deer Island and Nut Island Treatment Plants. Plant performance at Deer Island is compared to regulatory (interim) limits in Table II.B.1 and Figures II.B.1 through II.B.6. Aside from one instance of daily BOD exceeding the regulatory limits, the only violations of the regulatory limits in FY98 were for toxicity testing (see Table II.A.6).

Table II.B.1 Deer Island Effluent Quality Compared to Interim Limits			
Parameter	Interim Limits*	Range of Values Exceeding Limits	Number of Violations
Biochemical Oxygen Demand			
Monthly Avg (mg/L)	140		0
Daily Max (mg/L)	200	216	1
12-mo running removal rate (%)	27		0
Total Suspended Solids			
Monthly Avg (mg/L)	110		0
Daily Max (mg/L)	180		0
12-mo running removal rate (%)	38		0
Settleable Solids (mL/L)	2.8		0
Fecal Coliform (col/100 mL)	200		0
Total Coliform (col/100 mL)	1000		0
pH	6.5 - 8.5		0**
PHCs Effluent Dly. Max (mg/L)	15		0
Toxicity	@		11
Total Number of Violations			12
* Except for removal rates, the effluent quality must be equal or less than limits. Removal rates must be equal or greater than limits.			
** The interim limits for pH were violated 92 times during FY98 with the startup of the new secondary treatment systems. As expected with the operation of the pure oxygen system, pH of the effluent was lowered as excess CO ₂ (a result of biomass respiration) dissolved into the effluent. Since the violations are a direct result of the treatment process, they can be qualified. The new draft NPDES permit accounts for the expected lower pH by expanding the limits to 6.0-9.0. The lowered pH has no measureable impact on the quality of the receiving waters.			
@ See Table II.A.6			

Table II.B.2 compares the number of NPDES violations in FY98 to previous years.

Table II.B.2 NPDES Violations at Deer Island, FY94-FY98					
	FY94	FY95	FY96	FY97	FY98
BOD	16	12	7	0	1
TSS	1	1	0	0	0
Settleable Solids	0	0	0	0	0
Fecal Coliform	0	0	0	0	0
Total Coliform	0	1	0	0	0
pH	1	1	0	0	0
PHCs	1	4	5	0	0
Toxicity	11	17	19	16	11
Non-Toxicity Violations	19	19	12	0	1
Total Violations	30	36	31	16	12

For biochemical oxygen demand (BOD), as well as for total suspended solids (TSS), limits are placed on the daily maximum concentration, monthly average concentration and on the removal rate.³ The removal rate limit is for a 12-month running average of removal rates, rather than for the removal rate for an individual month. As can be seen from Figures II.B.1 and II.B.2, the monthly averages for BOD and TSS never exceeded the regulatory discharge limits (140 mg/L for BOD and 110 mg/L for TSS). Similarly, the 12-month running average removal rates for both TSS and BOD were always well above the regulatory minimum requirements. The daily maximum BOD was exceeded once during FY98 (on November 6, 1997). This violation occurred when the secondary treatment battery was temporarily taken off-line.

³A removal rate for a constituent is defined as the influent concentration minus the effluent concentration, divided by the influent concentration.

**Figure II.B.1
Deer Island Treatment Plant Effluent
BOD Trend Analysis, FY98**

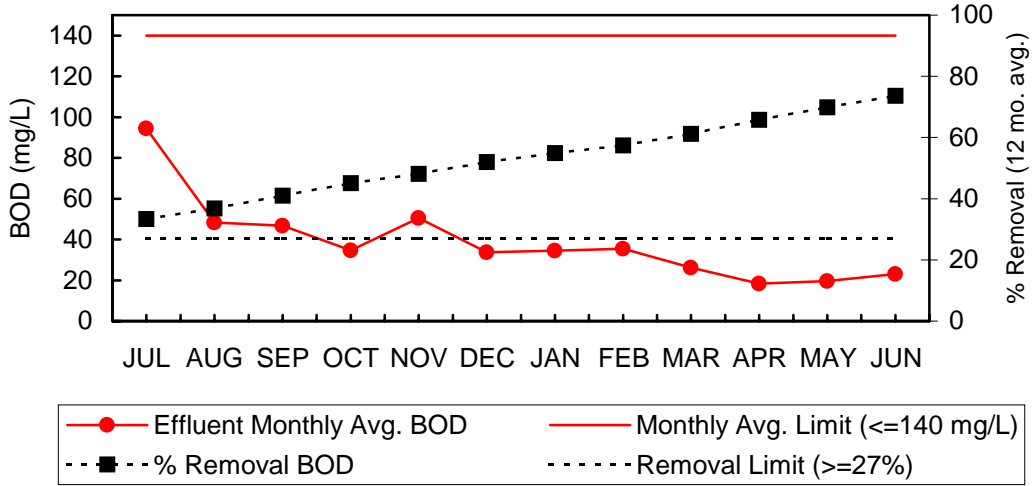

**Figure II.B.2
Deer Island Treatment Plant Effluent
TSS Trend Analysis, FY98**

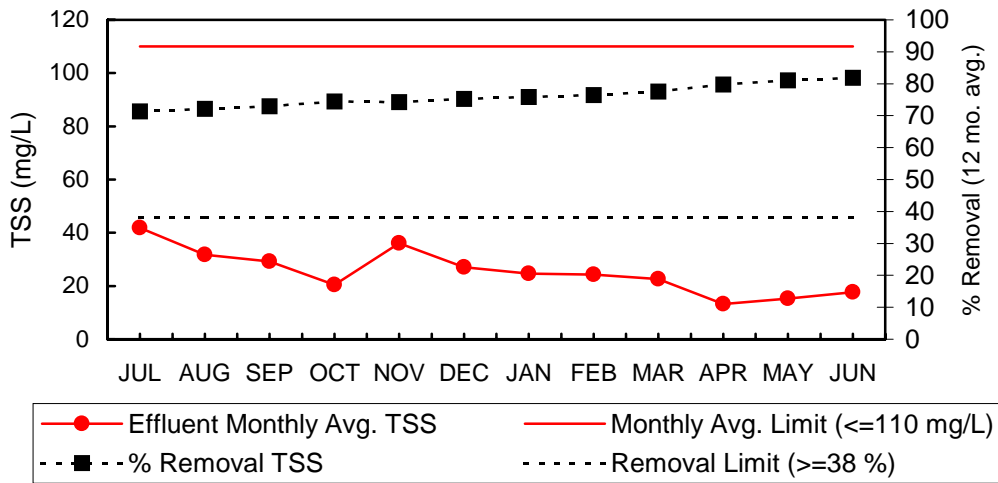

For fecal coliform, the monthly geometric mean of the count has a discharge limit of 200 colonies/100 mL. The results for Deer Island were well below this limit. (The monthly geometric mean never exceeded 11 col/100 mL.)

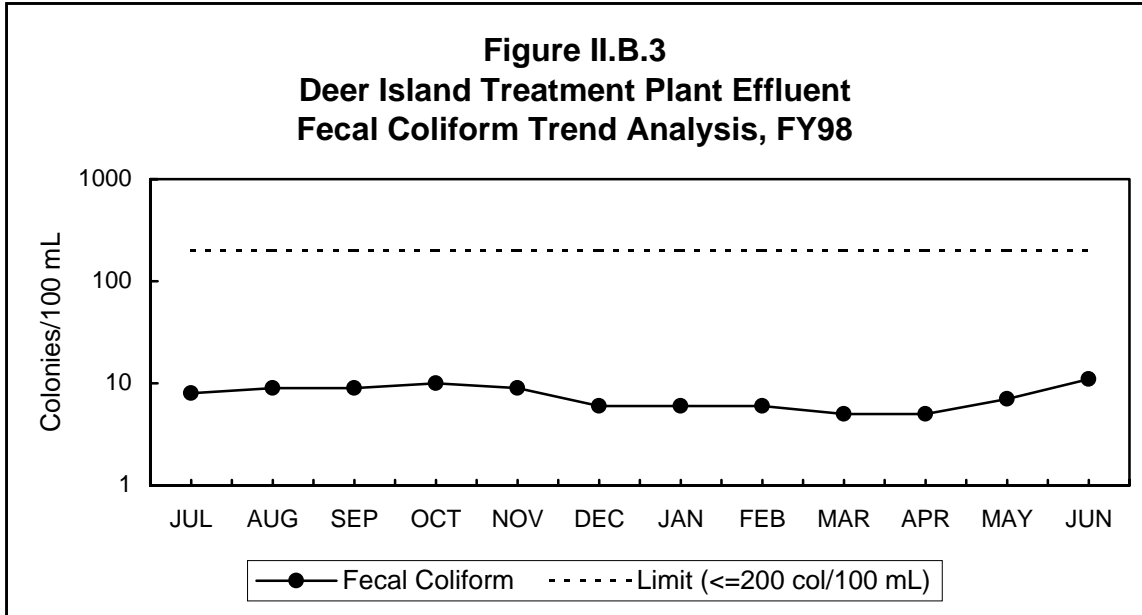

Likewise, total coliform counts were well below the limit of 1000 colonies/100 mL. The highest monthly geometric mean was 224 col/100 mL in June.

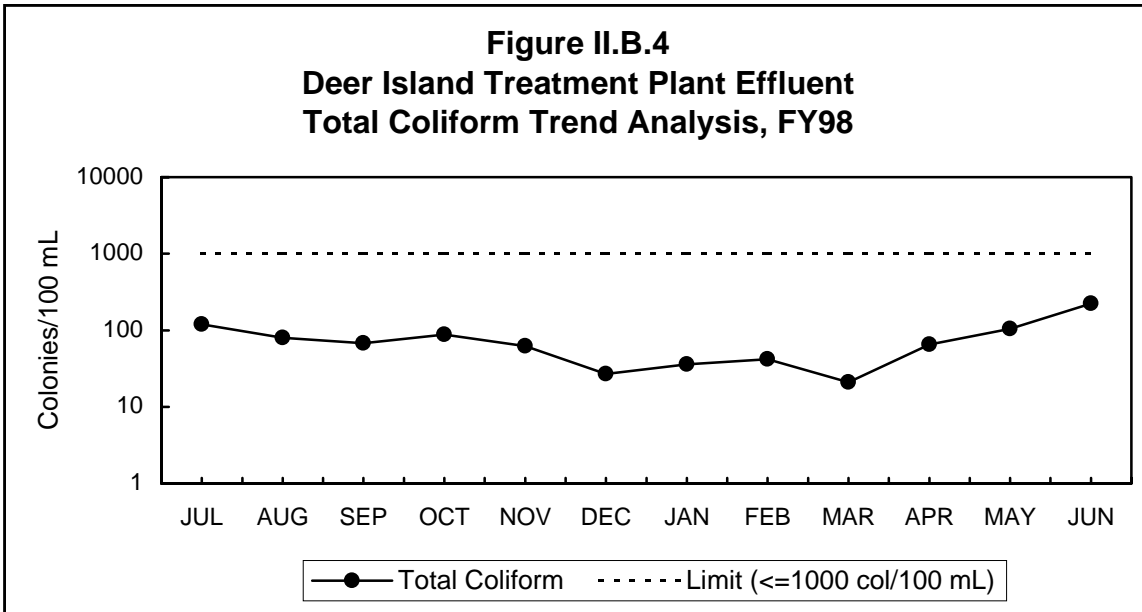

The limits for pH are based on the maximum and minimum values for each month, with pH required to fall between 6.5 and 8.5. In FY98, the pH of the effluent was always below the maximum of 8.5, but fell below the minimum value on 92 days. As explained in Table II.B.1, the startup of the new pure oxygen secondary treatment system caused this drop in pH. Excess carbon dioxide dissolves into the effluent and lowers the pH. The new draft NPDES permit makes allowances for the expected lower pH by expanding the limits to 6.0-9.0. The artificially lowered pH has no measurable impact on the quality of the receiving waters because of the buffering capacity of the receiving water.

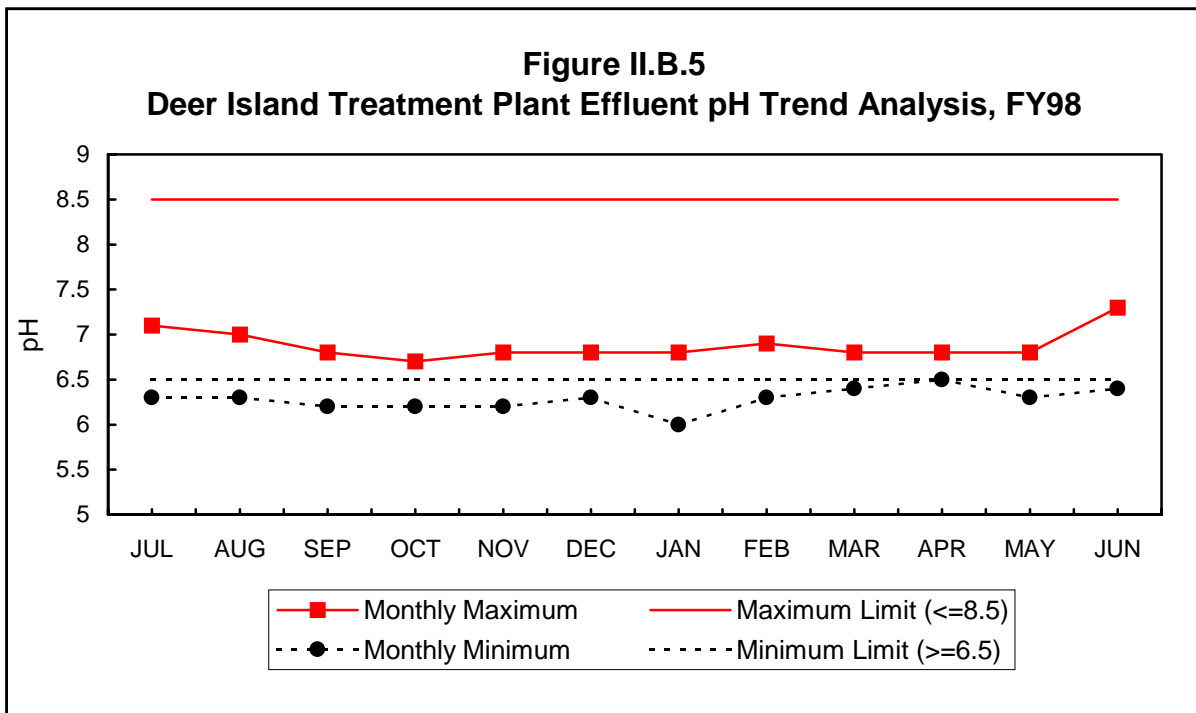

Deer Island Treatment Plant effluent concentrations were well below the maximum limit for settleable solids (2.8 mL/L), as Figure II.B.6 illustrates.

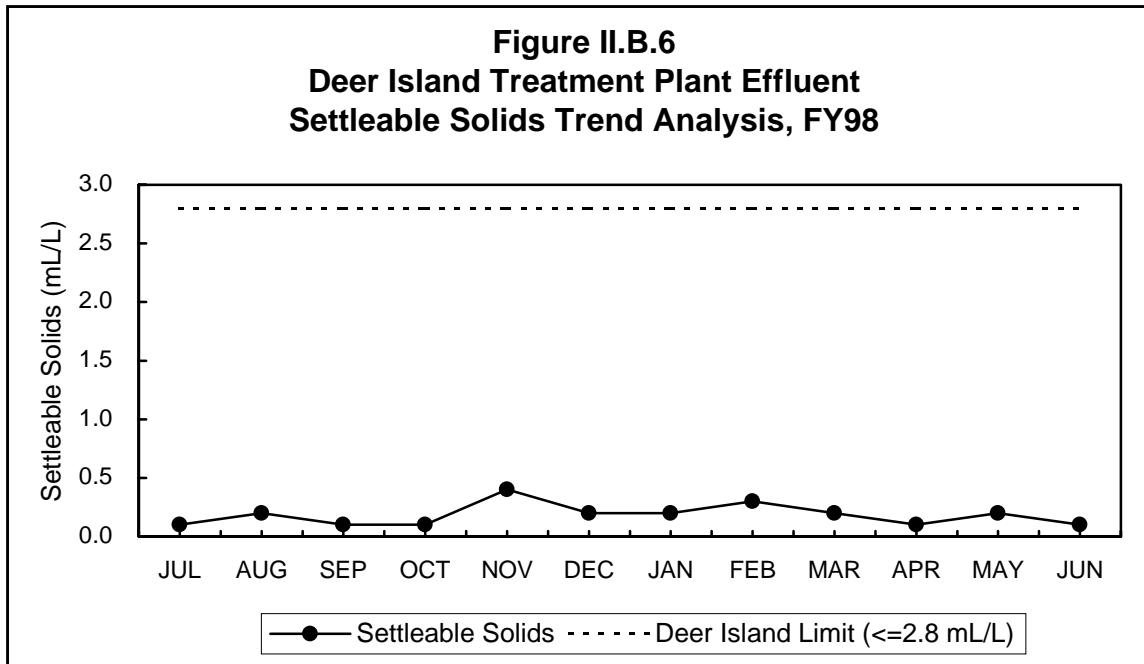

II.B.2 Effluent Quality Compared to Water Quality Standards

Concentrations of priority pollutants in Deer Island Treatment Plant effluent are compared to water quality criteria in Table II.B.3. The majority of priority pollutant parameters were below detection levels. Those that were detected had relatively low concentrations.

Table II.B.3 Comparison of Deer Island Treatment Plant Effluent with Water Quality Criteria, FY98

Parameter	Effluent Max Conc (ug/L)	Effluent Avg Conc (ug/L)	Times Detected	Acute Criterion* (ug/L)	Max Conc: Acute Criterion	Chronic Criterion* (ug/L)	Avg Conc: Chronic Criterion
Arsenic	2.43	0.85	15 of 90	69	<1	36	<1
Copper	110.00	27.56	80 of 91	2.9	38	2.9	10
Cyanide	20.90	5.88	4 of 39	1	21	1	6
Lead	25.60	5.29	77 of 90	220	<1	8.5	<1
Mercury	0.39	0.07	56 of 92	2.1	<1	0.025	3
Nickel	18.60	4.12	2 of 90	75	<1	8.3	<1
Silver	6.11	1.26	47 of 89	2.3	3	NA	NA
Zinc	119.00	46.57	90 of 91	95	1	86	<1

* EPA's recommended water quality criteria for marine receiving waters. (These criteria were subsequently updated in 12/98.)

Given a theoretical minimum dilution of 10:1 (and an average dilution of 20:1 to 25:1), most of the priority pollutants that were detected would not violate EPA's water quality criteria, as Table II.B.3 shows. Only copper and cyanide showed concentrations that would possibly violate the criteria (and the detection of cyanide is likely the result of interferences created by laboratory procedures).

Copper

Copper concentrations were high enough to cause concern. A 38-fold dilution would be required to bring the maximum concentration below the acute water quality criterion, while a ten-fold dilution would be needed to bring the average effluent concentration below the chronic water quality criterion. The source of much of the copper entering the sewer system is likely from households where an acidic water supply leaches copper from copper pipes.

Cyanide

Although the lab results show that cyanide was detected 4 times, it is generally agreed that the tests used to detect cyanide can under certain conditions produce false positive results. The Water Environment Research Foundation, in cooperation with the Association of Metropolitan Sewerage Agencies, is conducting research on this issue.

III Nut Island Treatment Plant

This chapter presents and discusses monitoring information for the Nut Island Treatment Plant (NITP). The characteristics examined include flow, conventional parameters, nutrients, priority pollutants (metals, cyanide, pesticides/PCBs, and organic compounds), and whole effluent toxicity.

During the last three months of FY98, increasingly larger volumes of NITP effluent – 50% of the effluent in April, 75% in May, and 90% in June – were discharged to the Inter-Island Tunnel to test the South System Pump Stations at Deer Island. During these months, this portion of Nut Island effluent was added to the total Deer Island influent flow.

III.A Monitoring Results

III.A.1 Influent Characteristics

III.A.1.a Flow

The monthly average flow to the Nut Island Treatment Plant in FY98 was 130 mgd. Figure III.A.1, which compares flow to precipitation, shows the influence of precipitation on the monthly average flow.

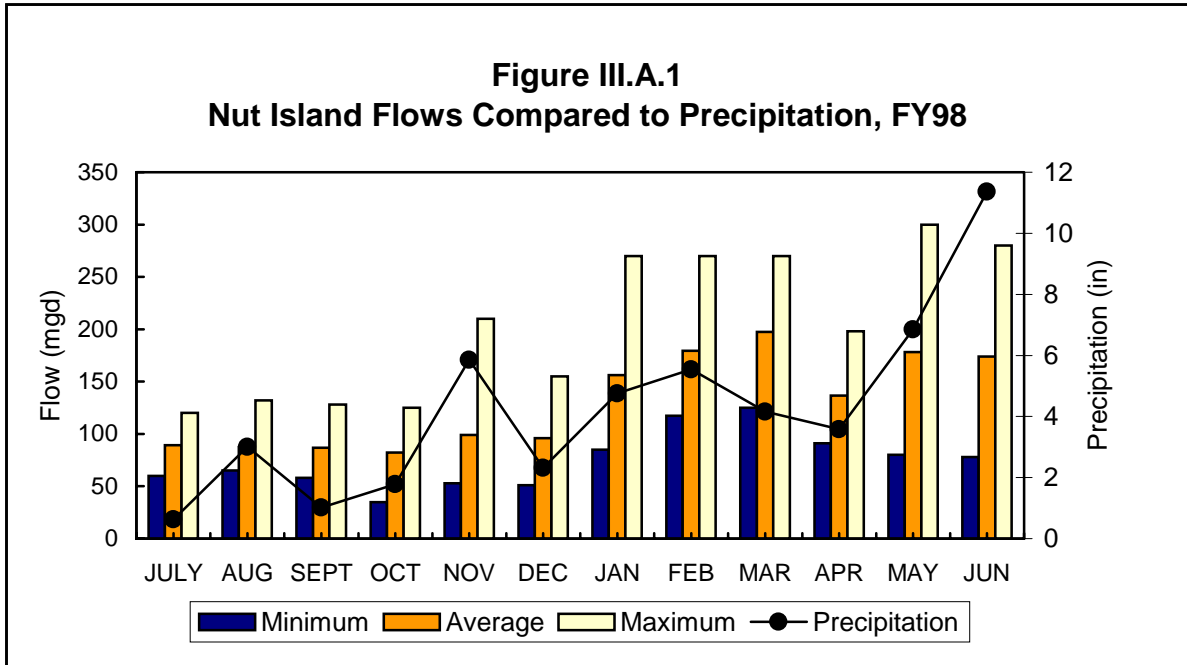

Figure III.A.2 compares monthly Nut Island flows in FY98 with historical averages.

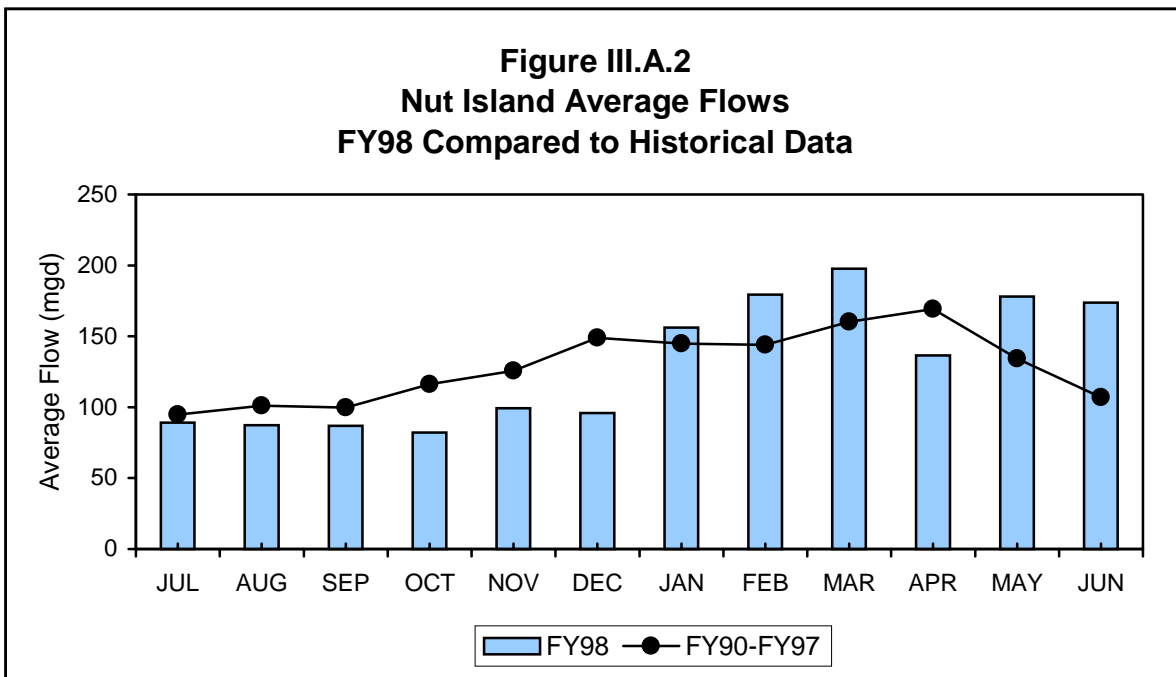
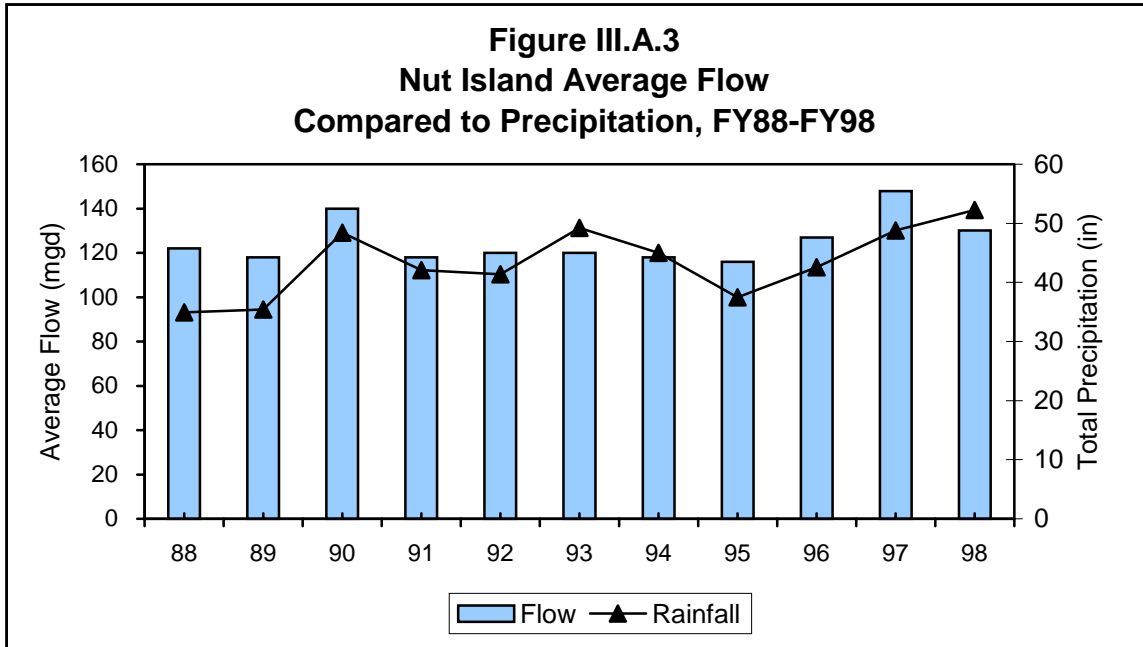

Figure III.A.3 tracks average flow and precipitation over the past 11 years. Yearly flows have followed the same general trend as rainfall during this period.



III.A.1.b Conventional Parameters and Nutrients

As can be seen in Table III.A.1, NITP influent can be classified as weak to medium.¹ A summary of conventional and nutrient concentrations and loadings in Nut Island influent from FY93-FY98 is provided in Table III.A.2. There has been little change in influent characteristics over the past few years.

Table III.A.1 Classification of Nut Island Influent (mg/L), FY98

<u>Parameter</u>	<u>Value</u>	<u>Weak</u>	<u>Medium</u>	<u>Strong</u>
TSS	129	100	200	350
BOD	121	100	200	300
TKN	30	20	40	85
Ammonia	19	12	25	50

¹Metcalf & Eddy, Inc. 1972. Wastewater Engineering: Collection, Treatment, Disposal. New York: McGraw-Hill Book Company, p. 231.

Table III.A.2 Nut Island Influent Characterization, FY93-FY98

PARAMETER	FY93	FY94	FY95	FY96	FY97	FY98
Flow (MGD)						
Minimum	50	47	70	40	73	35
Average	129	123	111	127	148	130
Maximum	262	315	211	260	280	300
Total Suspended Solids						
Min Conc (mg/L)	112	122	111	18	12	13
Avg Conc (mg/L)	174	227	158	154	126	129
Max Conc (mg/L)	206	354	209	496	450	348
Average Loading (tons/d)	94	116	73	82	78	70
Biochemical Oxygen Demand						
Min Conc (mg/L)	122	97	100	22	28	20
Avg Conc (mg/L)	177	171	148	131	109	121
Max Conc (mg/L)	251	247	212	256	263	357
Average Loading (tons/d)	95	88	69	69	67	66
Settleable Solids						
Min Conc (mL/L)	5.1	2.7	3.8	2.0	1.0	1.0
Avg Conc (mL/L)	8.0	7.5	6.2	8.8	6.2	5.9
Max Conc (mL/L)	10.5	19.8	11.1	40.0	12.0	29.0
Average Loading (tons/d)	4.3	3.8	2.9	4.7	3.8	3.2
Oil and Grease						
Min Conc (mg/L)	11	6	15	23	14	7
Avg Conc (mg/L)	35	31	28	32	30	31
Max Conc (mg/L)	59	115	38	40	57	124
Average Loading (tons/d)	19	16	13	17	18	17
Total Kjeldahl Nitrogen						
Min Conc (mg/L)	10.57	10.08	9.80	9.38	14.20	9.41
Avg Conc (mg/L)	19.40	22.84	24.45	25.27	28.03	30.06
Max Conc (mg/L)	25.20	34.79	33.80	44.80	42.60	46.70
Average Loading (tons/d)	10.44	11.71	11.32	13.38	17.28	16.32

Table III.A.2 Nut Island Influent Characterization, FY93-FY98 [cont.]

PARAMETER	FY93	FY94	FY95	FY96	FY97	FY98
Ammonia-Nitrogen						
Min Conc (mg/L)	5.01	2.24	5.32	4.28	9.22	6.09
Avg Conc (mg/L)	13.66	10.06	14.52	15.73	17.28	18.80
Max Conc (mg/L)	20.07	20.44	23.10	34.10	28.00	32.60
Average Loading (tons/d)	7.35	5.16	6.72	8.33	10.65	10.21
Nitrates						
Min Conc (mg/L)	0.00	0.00	0.03	< 0.01	< 0.01	< 0.0075
Avg Conc (mg/L)	0.21	0.20	0.23	0.52	0.02	0.10
Max Conc (mg/L)	0.58	0.51	0.91	1.93	0.19	0.927
Average Loading (tons/d)	0.11	0.10	0.11	0.28	0.02	0.05
Nitrites						
Min Conc (mg/L)	*	0.00	0.03	< 0.01	< 0.01	< 0.01
Avg Conc (mg/L)	*	0.05	0.06	0.37	0.02	0.03
Max Conc (mg/L)	*	0.09	0.15	1.31	0.15	0.161
Average Loading (tons/d)		0.03	0.03	0.20	0.01	0.02
Orthophosphorus						
Min Conc (mg/L)	*	0.10	0.85	0.29	0.78	0.633
Avg Conc (mg/L)	*	1.64	2.16	1.39	1.39	1.86
Max Conc (mg/L)	*	2.70	3.93	3.30	1.98	3.08
Average Loading (tons/d)		0.84	1.00	0.74	0.86	1.01
Total Phosphorus						
Min Conc (mg/L)	1.83	0.90	2.20	1.22	1.37	1.66
Avg Conc (mg/L)	3.22	2.97	4.60	3.59	3.63	4.21
Max Conc (mg/L)	3.99	4.60	13.57	6.85	5.28	6.52
Average Loading (tons/d)	1.73	1.52	2.13	1.90	2.24	2.29

* Not Analyzed

III.A.1.c Priority Pollutants

Priority pollutant concentrations in Nut Island Treatment Plant influent can be found in Table B-2 of Appendix B, while influent loadings are in Table B-3.

As with the Deer Island results, one half of the method detection limit for metals and one tenth of the quantitation limit for organics were substituted for measurements below detection limits. A discussion of detection and quantitation limits can be found in Appendix K.

FY98 influent metals loadings for several key metals are compared to historical values in Figure III.A.4. (See Table B-3 in Appendix B for more details about metals influent loading in FY98.) The slight increase in loadings in FY97 may be due to high flows on sampling days.

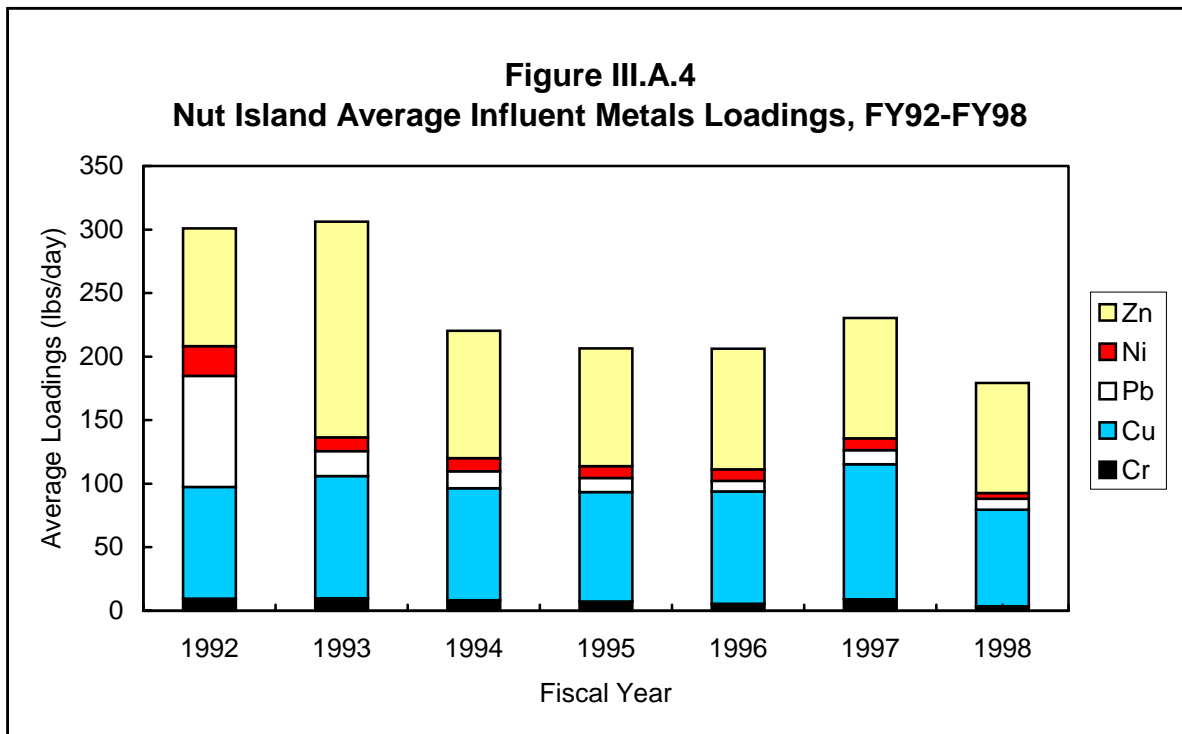
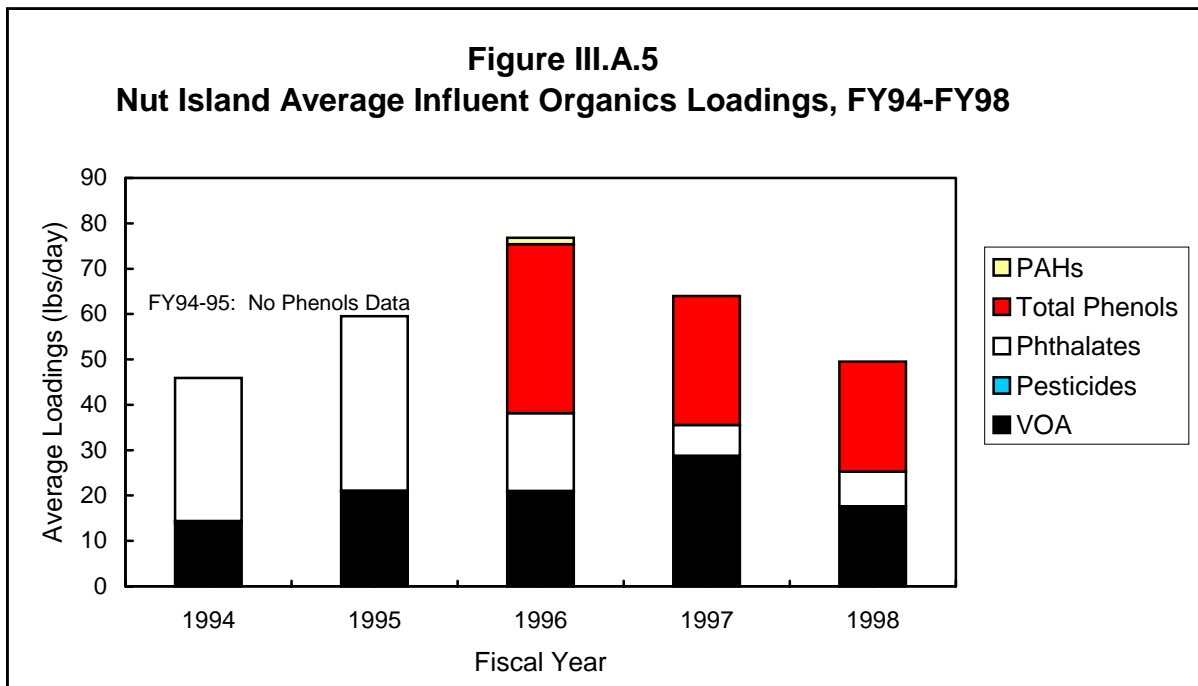

Figure III.A.5 compares FY98 influent loadings of certain representative organic priority pollutants to previous years. The chart shows that organics influent loadings have been decreasing since FY96. There was probably a decrease in the preceding two years as well, but that cannot be seen in this graph because there were no data available on phenols in FY94 and FY95. As was discussed in Chapter II (Section II.A.1.c), the figure includes the average loading (lbs/day) of those pollutants that were detected at least once. These average values include the non-detected samples (substituting a concentration of one-tenth of the reporting limit).



III.A.2 Effluent Characteristics

III.A.2.a Conventional Parameters

Nut Island Treatment Plant removal efficiencies were compatible with theoretical removal efficiencies for primary treatment, as indicated in Table III.A.3. Monitoring results for Nut Island conventional parameters and nutrients over the past six years are summarized in Table III.A.4. There were no significant changes in conventional parameters compared to past years.

<u>Parameter</u>	<u>Primary Treatment Removal Efficiency</u>	
	<u>NITP</u>	<u>Theoretical</u>
TSS	56%	50-65%
BOD	36%	25-40%

III.A.2.b Nutrients

A comparison of nutrient concentrations in NITP effluent in FY98 to previous years is presented in Figure III.A.6. Nitrate and nitrite loadings in FY98 have decreased when compared with the previous five years. TKN has shown an increasing trend, while orthophosphorus and total phosphorus have shown little change. Ammonia has increased gradually over each of the past few years (as Table II.A.4 shows). This has most likely been caused by increasing use of the Fore River sludge pelletizing plant, which discharges ammonia-rich process waters to the Nut Island Treatment Plant.

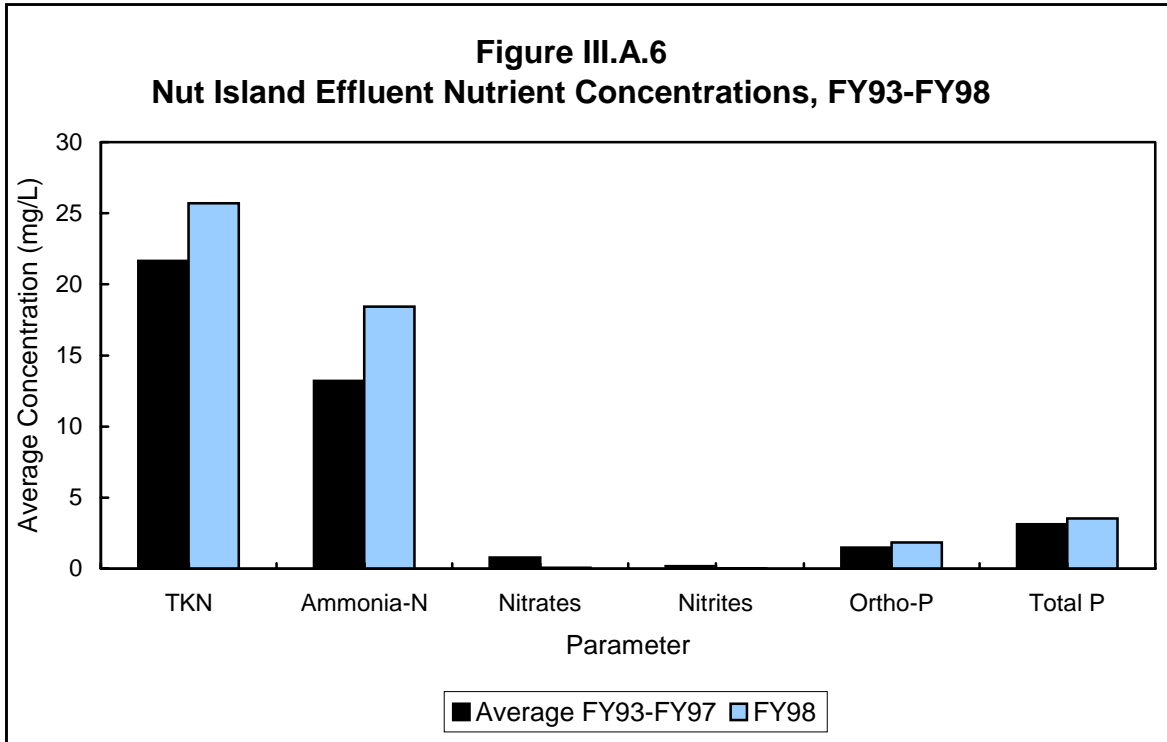

III.A.2.c Priority Pollutants

Tables B-4 and B-5 in Appendix B summarize priority pollutant concentrations and loadings in NITP effluent for FY98. Metals loadings over the past ten years are plotted in Figure III.A.7. Figure III.A.8 contains information on organic priority pollutants from FY94-FY98. Generally, the same metals and other priority pollutants were detected in the effluent as were found in the influent, as in the Deer Island results.

Figure III.A.7
Nut Island Average Effluent Metals Loadings, FY89-FY98

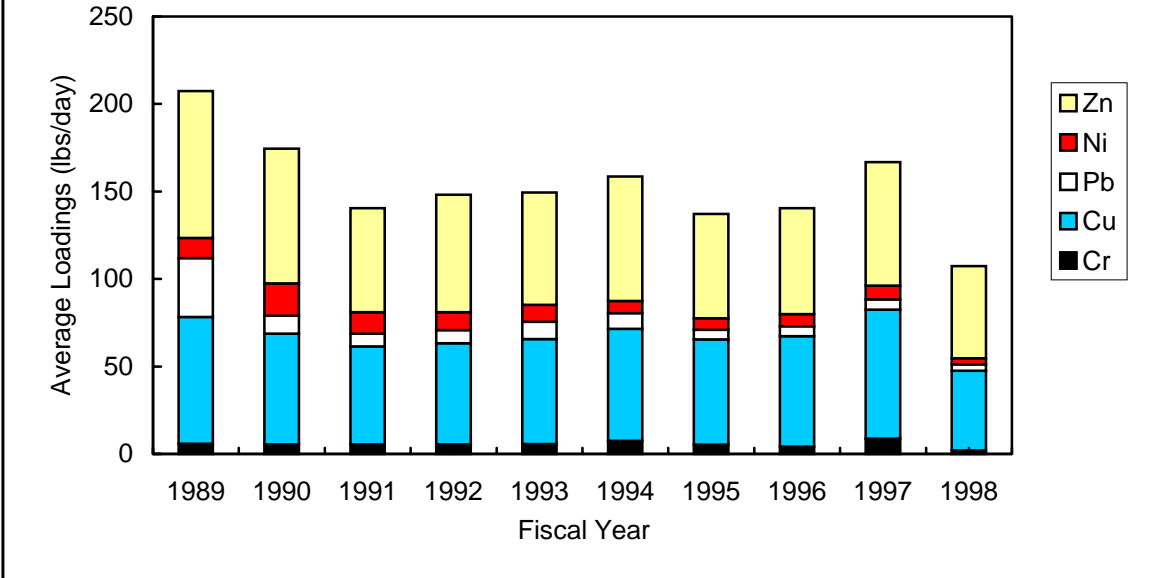

Figure III.A.8
Nut Island Average Effluent Organics Loadings, FY94-FY98

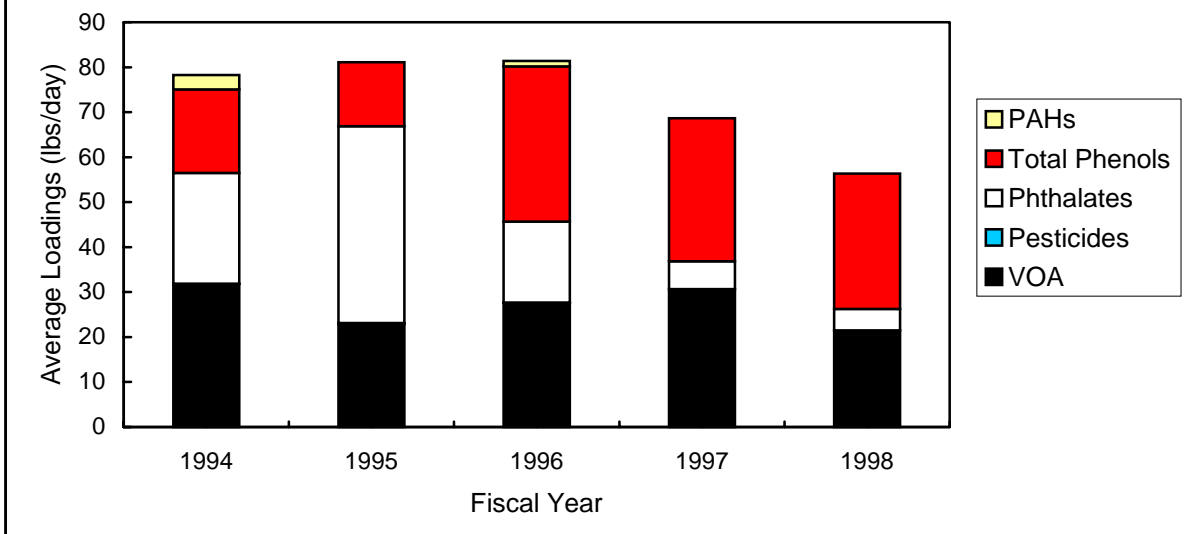

Table III.A.4 Nut Island Effluent Characterization, FY93-FY98

Parameter	FY93	FY94	FY95	FY96	FY97	FY98
Flow (mgd)						
Minimum	50	47	70	40	73	35
Average	129	123	111	127	148	130
Maximum	262	315	211	260	280	300
Total Suspended Solids (TSS)						
Min Conc (mg/L)	44	53	48	24	14	9
Avg Conc (mg/L)	66	78	75	68	62	57
Max Conc (mg/L)	80	100	94	200	162	188
Average Loading (tons/d)	36	40	35	36	38	31
Biochemical Oxygen Demand (BOD)						
Min Conc (mg/L)	64	74	65	22	25	12
Avg Conc (mg/L)	103	108	108	84	78	77
Max Conc (mg/L)	142	136	143	210	158	200
Average Loading (tons/d)	55	55	50	44	48	42
Settleable Solids						
Min Conc (mL/L)	0.8	0.5	0.5	0.1	0.1	0.1
Avg Conc (mL/L)	1.1	0.9	6.2	1.0	1.3	0.69
Max Conc (mL/L)	1.3	1.1	11.1	5.5	3.0	7
Average Loading (tons/d)	0.6	0.5	2.9	0.5	0.8	0.4
Oil and Grease (mg/L)						
Min Conc (mg/L)	8.0	2.1	13.9	20.8	14.4	7
Avg Conc (mg/L)	22.7	16.4	24.0	26.8	23.0	25
Max Conc (mg/L)	37.2	25.3	33.7	31.8	31.4	82
Average Loading (tons/d)	12.2	8.4	11.1	14.2	14.2	13.6
Total Kjeldahl Nitrogen						
Min Conc (mg/L)	7.14	11.90	11.20	10.10	15.80	6
Avg Conc (mg/L)	16.41	19.97	21.86	23.98	26.02	25.7
Max Conc (mg/L)	24.58	26.39	30.30	44.20	39.20	40
Average Loading (tons/d)	8.83	10.24	10.12	12.70	16.04	13.95

Table III.A.4 Nut Island Effluent Characterization, FY93-FY98 [cont.]

Parameter	FY93	FY94	FY95	FY96	FY97	FY98
Ammonia-Nitrogen						
Min Conc (mg/L)	2.45	2.80	6.09	3.96	8.48	5.58
Avg Conc (mg/L)	11.25	10.24	13.51	14.73	16.27	18.44
Max Conc (mg/L)	17.35	17.78	19.60	23.70	26.50	33.60
Average Loading (tons/d)	6.05	5.25	6.25	7.80	10.03	10.01
Nitrates						
Min Conc (mg/L)	0.03	0.09	0.03	< 0.01	< 0.01	< 0.01
Avg Conc (mg/L)	0.82	0.80	1.25	0.88	0.17	0.07
Max Conc (mg/L)	1.50	1.79	1.79	2.48	0.52	0.527
Average Loading (tons/d)	0.44	0.41	0.58	0.47	0.11	0.04
Nitrites						
Min Conc (mg/L)	0.06	0.01	0.07	< 0.01	< 0.01	< 0.01
Avg Conc (mg/L)	0.24	0.07	0.25	0.22	0.08	0.03
Max Conc (mg/L)	0.76	0.16	0.52	0.32	0.25	0.107
Average Loading (tons/d)	0.13	0.04	0.12	0.12	0.05	0.02
Orthophosphorus						
Min Conc (mg/L)	0.24	0.49	0.85	0.32	0.86	0.511
Avg Conc (mg/L)	1.32	1.69	1.92	1.13	1.35	1.85
Max Conc (mg/L)	2.83	2.50	3.05	2.51	1.96	2.83
Average Loading (tons/d)	0.71	0.87	0.89	0.60	0.83	1.00
Total Phosphorus						
Min Conc (mg/L)	1.50	0.26	0.27	1.15	1.23	1.24
Avg Conc (mg/L)	3.50	2.57	3.38	3.05	3.08	3.54
Max Conc (mg/L)	9.13	3.85	4.75	4.64	4.17	5.13
Average Loading (tons/d)	1.88	1.32	1.56	1.62	1.90	1.92

III.A.2.d Whole Effluent Toxicity

The same three toxicity tests were used for NITP effluent as for DITP (see Section II.A.2.d). The results of these tests are presented in Table III.A.5.

Table III.A.5					
Nut Island Effluent, Results of Toxicity Testing, FY98					
	<u>Mysid Shrimp acute</u>		<u>Sheepshead Minnow chronic</u>		<u>Red Algae chronic</u>
	LC50	NOEC	Survival NOEC	Growth NOEC	NOEC
Limits (%)	None	20	10	10	10
	51				
July	33	20	20	20	<0.2
August	32	20	40	40	<0.2
September	27	10	40	40	0.2
October	55	10	10	10	0.7
November	43	20	20	20	*
December	>100	10	20	20	<0.2
January	>100	20	40	40	2
February	18	50	100	100	*
March	72	<5	100	60	<0.2
April	58	50	60	60	<0.2
May	55	50	20	20	2
June		20	40	40	0.7
	>54				
FY98 Average		24	43	39	<0.6
# of Violations		4	0	0	10

*Test invalid due to failure of controls to meet acceptability requirements.

Toxicity at Nut Island was similar to past years. The sheepshead minnow test results were in compliance 100% of the time, and the mysid acute test was in compliance 67% of the time; the results of the red algae test were never in compliance. Due to questions regarding the sensitivity and reliability of the red algae test, the Region I EPA is withdrawing it as a test species in future permits.

III.B Discussion

III.B.1 Compliance with Regulatory Limits

The Nut Island Treatment Plant, like DITP, is regulated by court-ordered interim limits. Plant performance at Nut Island is compared to regulatory limits in Table III.B.1 and Figures III.B.1 through III.B.6. In addition to the 14 toxicity violations, there were 10 other violations of regulatory limits at Nut Island in FY98, including 6 times when the minimum pH fell below the limit, 2 violations of the daily maximum limit for PHCs, and one violation of the monthly geometric mean for total coliform.

Table III.B.1 Nut Island Effluent Quality Compared to Interim Limits			
Parameter	Interim Limits*	Range of Values Exceeding Limits	Number of Violations
Biochemical Oxygen Demand			
Monthly Avg (mg/L)	130		0
Daily Max (mg/L)	185	200	1
12-mo running removal rate (%)	15		0
Total Suspended Solids			
Monthly Avg (mg/L)	110		0
Daily Max (mg/L)	195		0
12-mo running removal rate (%)	43		0
Settleable Solids (ml/L)	1.8		0
Fecal Coliform (col/100 mL)	200		0
Total Coliform (col/100 mL)	1000	1270	1
pH	6.5 - 8.5	6.4	6
PHCs Effluent Dly. Max (mg/L)	15	67.9, 65.3	2
Toxicity	@		14
Total Number of Violations			24
* Except for removal rates, the effluent quality must be less than or equal to limits. Removal rates must be equal to or greater than limits.			
@ See Table III.A.5			

Table III.B.2 compares the number of NPDES in FY98 to previous years.

Table III.B.2 NPDES Violations at Nut Island, FY94-FY98					
	FY94	FY95	FY96	FY97	FY98
BOD	8	9	7	0	1
TSS	1	3	0	0	0
Settleable Solids	0	0	0	0	0
Fecal Coliform	0	0	0	0	0
Total Coliform	0	0	0	0	1
pH	7	9	0	4	6
PHCs	0	4	5	1	2
Toxicity	20	19	19	15	14
Non-Toxicity Violations	16	25	12	5	10
Total Violations	36	44	31	20	24

For biochemical oxygen demand (BOD), limits are placed on the monthly average concentration and on the removal rate. The removal rate limit is for a 12-month running average of removal rates, rather than for the individual month's removal rate. As shown in Figure III.B.1, the monthly average BOD never exceeded the regulatory limit of 130 mg/L. The 12-month running average of monthly removal rates was always greater than the limit of 15%. Over the course of the fiscal year, average effluent BOD concentration dropped and the 12-month average removal rate rose.

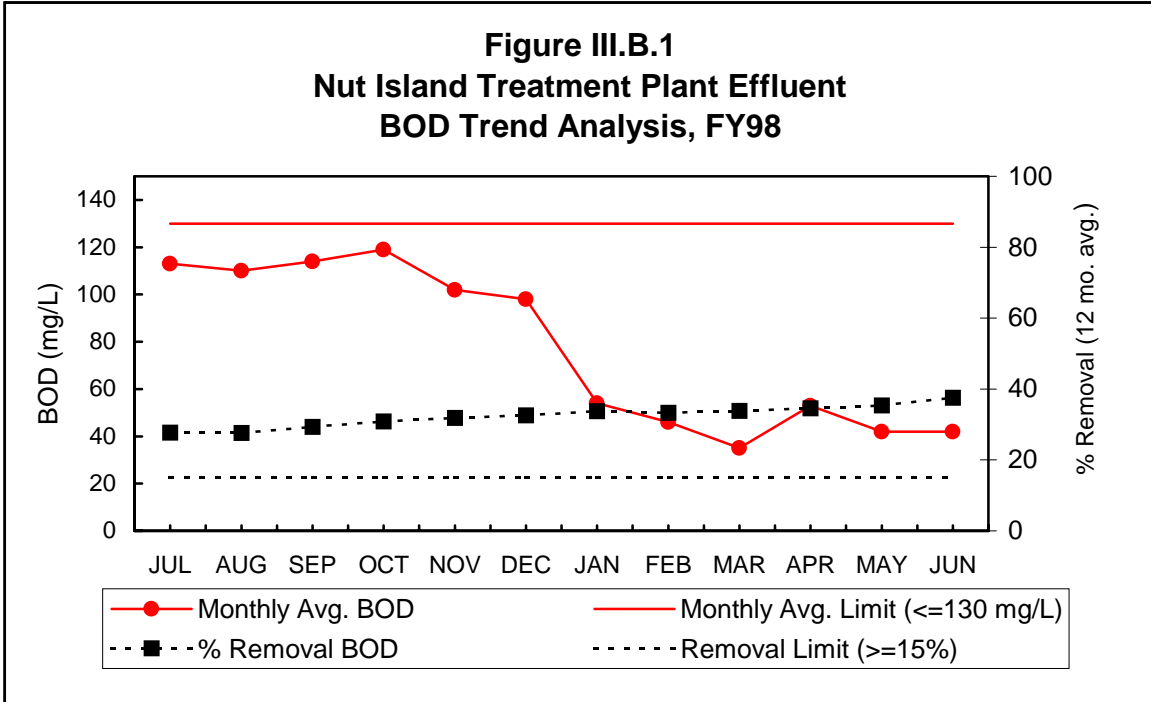

Total suspended solids, or TSS, are also limited for both average concentration and 12-month removal rate. Figure III.B.2 shows the trend for TSS in the Nut Island effluent. As seen from the graph, monthly average TSS was always less than the regulatory limit of 110 mg/L, and the running 12-month average of TSS removal rate was always greater than 43%. Over the course of the fiscal year, average effluent BOD concentration dropped and the 12-month average removal rate rose.

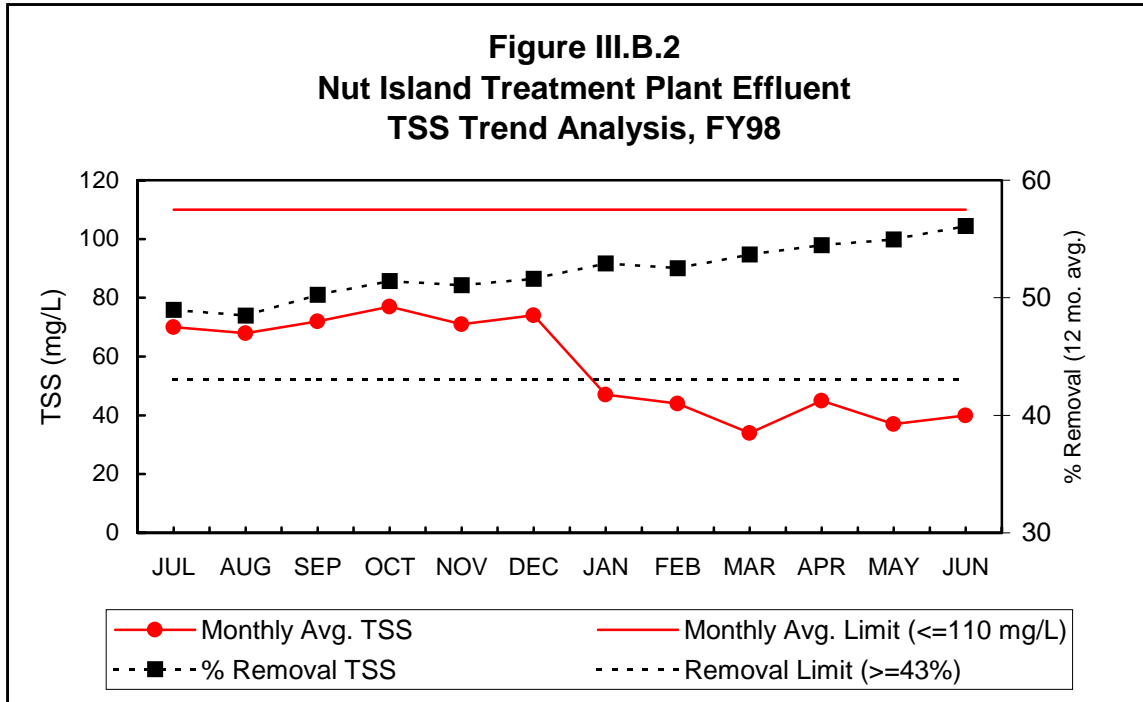

For fecal coliform, the monthly geometric mean of the count has a limit of 200 colonies/100 mL. The results for NITP, as for DITP, were far below this limit. Most months had an average (geometric mean) count of about 10 col/100 mL, with the exception of June, which had a mean of 87 col/100 mL. The chlorination system could not keep up with the high amount of flow entering the system.

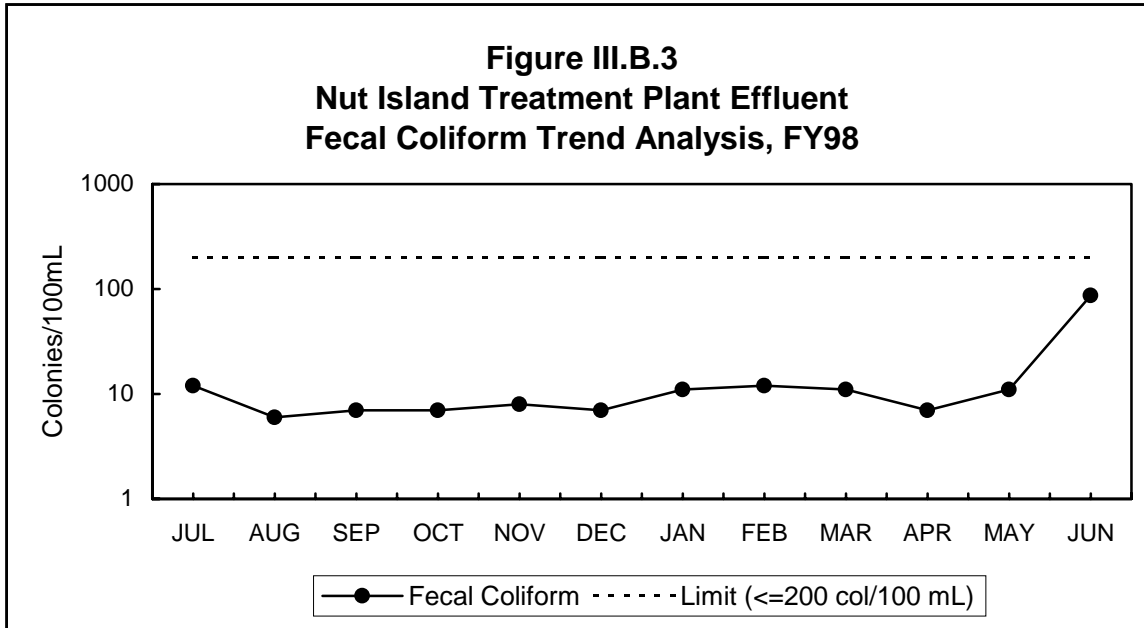

Likewise, total coliform counts were well below the limit of 1000 colonies/100 mL, except for June 1998, which had an average (geometric mean) fecal coliform count of 1270 col/100 mL (due to increased flows). No other month in FY98 exceeded a count of 180 col/100 mL.

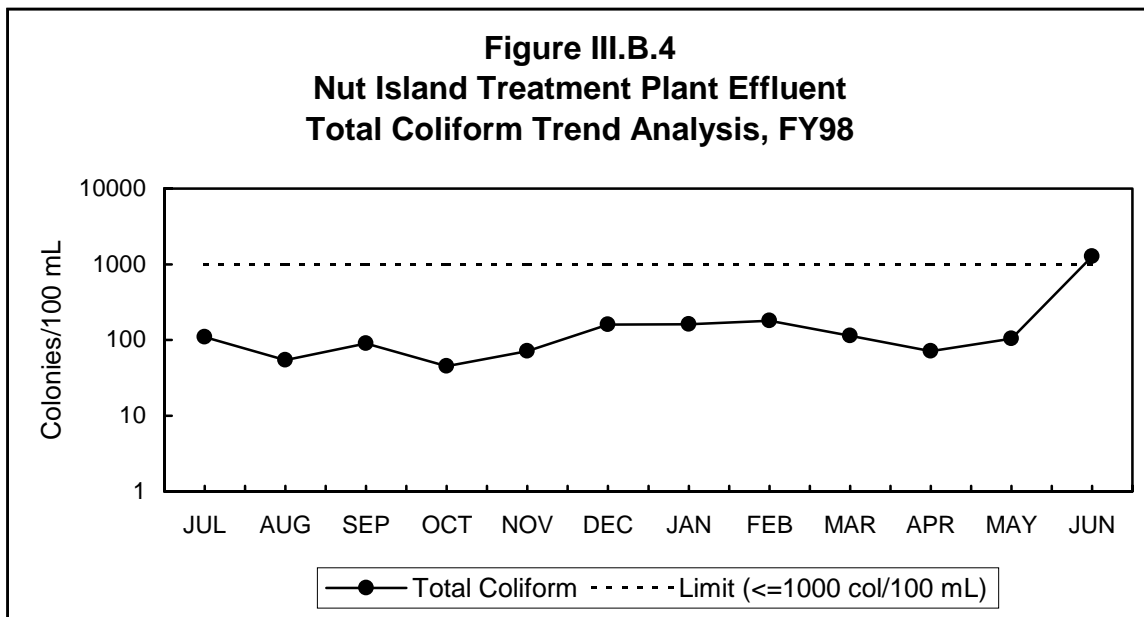

The limits for pH are based on the maximum and minimum values for each month, with pH required

to fall between 6.5 and 8.5. Nut Island effluent pH fell below the minimum value required on six days in FY98, probably as a result of the effects of acid rain. Effluent pH never exceeded the maximum limit of 8.5.

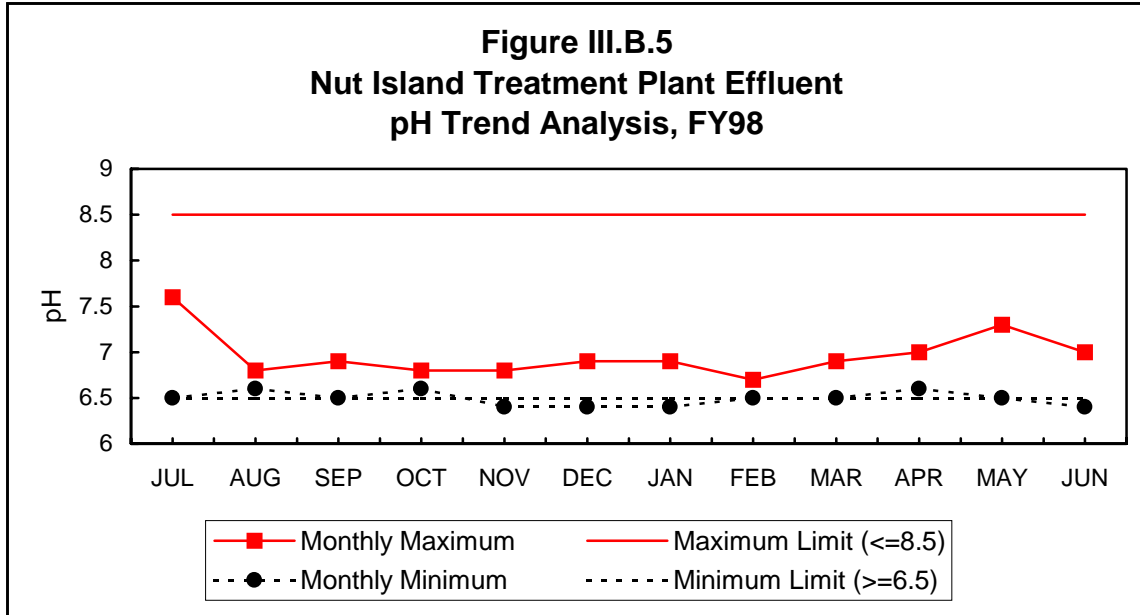

There is also a maximum limit for settleable solids. Concentrations in Nut Island effluent were well below this limit.

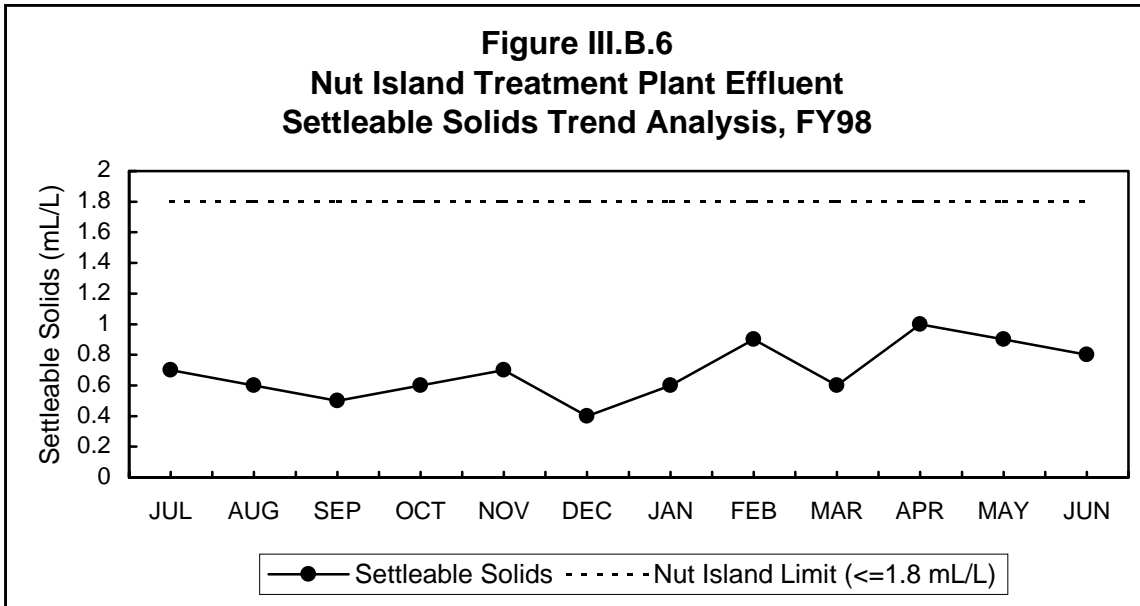

III.B.2 Effluent Quality Compared to Water Quality Standards

Table III.B.3 presents a comparison of pollutant concentrations in Nut Island effluent to water quality standards for those pollutants. As at Deer Island, most priority pollutant parameters were found to be below detection levels, and those that were detected had relatively low concentrations. The only substances that have high enough concentrations to exceed water quality criteria given the expected dilution were copper and cyanide (and the detection of cyanide is likely the result of interferences created by laboratory procedures).

Parameter	Effluent Max Conc (ug/L)	Effluent Avg Conc (ug/L)	Times Detected	Acute Criterion* (ug/L)	Max Conc: Acute Criterion	Chronic Criterion* (ug/L)	Avg Conc: Chronic Criterion
Arsenic	2.20	0.74	4 of 86	69	<1	36	<1
Copper	225.00	54.04	87 of 87	2.9	78	2.9	19
Cyanide	117.00	9.89	8 of 37	1	117	1	10
Lead	12.30	4.41	79 of 86	220	<1	8.5	<1
Mercury	0.38	0.11	73 of 86	2.1	<1	0.025	4
Nickel	8.41	4.12	4 of 86	75	<1	8.3	<1
Silver	20.25	2.33	66 of 86	2.3	9	NA	NA
Zinc	210.00	62.59	87 of 87	95	2	86	<1

* EPA's recommended water quality criteria for marine receiving waters. (These criteria were subsequently updated in 12/98.)

Copper

The dilution required to meet the acute water quality criterion for copper was 78:1, while the critical dilution needed to meet the chronic criterion was 19:1. It is believed that most of the copper entering the sewer system comes from households where an acidic water supply leaches copper from copper pipes.

Cyanide

Although cyanide was detected in the effluent in high enough concentrations to be a cause for concern, there is doubt about the validity of the test for the presence of cyanide, as discussed in Chapter 2.

IV Combined Sewer Overflow Facilities

MWRA monitors six Combined Sewer Overflow (CSO) facilities in the North System. The monitoring results vary significantly between facilities because of differences in the type and location of the facilities.

At each of the CSO facilities, the combined wastewater (sewage and stormwater) is chlorinated prior to discharge. Of the six CSO facilities, only the Cottage Farm and Prison Point facilities have pumping and tank storage capacity. This allows for chlorinated wastewater to be held at these facilities, up to their storage capacities, prior to discharge. Any wastewater exceeding the storage capacity will overflow and is discharged to the river. The four other CSO facilities – Somerville Marginal, Constitution Beach, Fox Point and Commercial Point – are gravity CSO facilities, which means that combined wastewater arrives and leaves the CSO facility by gravity, instead of pumping. The combined wastewater is disinfected, and the chlorinated wastewater overflows to the receiving water as quickly as it arrives at the facility. A detailed description of the six CSO facilities can be found in Appendix J.

IV.A Cottage Farm Combined Sewer Overflow Facility

IV.A.1 Activations

Table IV.A.1 and Figures IV.A.1 and IV.A.2 summarize activation data for the Cottage Farm CSO facility. There was a measurable decrease in total volume treated from FY97 to FY98. Although the total rainfall in FY98 was only slightly higher than in FY97, there were several high intensity rainfall events in FY98, especially in last two months of the fiscal year. It is likely that when the Cottage Farm CSO was activated during an intense storm, its capacity was quickly exceeded, and the excess

flows were discharged at relief points along the Charles River before they reached the CSO treatment facility. As a result, the volume treated in FY98 was much less than the volume treated in the previous year, despite the comparable amounts of rainfall.

Alternatively, the reduction in volume treated at the CSO facility from FY97 to FY98 might also be attributed to increased pumping capacity at Deer Island, since the Cottage Farm CSO facility is hydraulically linked to Deer Island. This explanation would not hold true during the intense storms; for example, there were record flows at Deer Island from June 13-18, and the CSO facility at Cottage Farm was constantly activated.

Almost half of the total treated volume, or 370 MG, was treated in the month of June, and about 68% of the total volume was treated in May and June. February accounted for about 11% of the total treated volume, or 86 MG, due to two high intensity storms, plus snowmelt.

Since much of the rainfall in FY98 fell during a small number of intense storms, the number of the Cottage Farm CSO activations decreased in FY98 as compared with previous years.

	FY92	FY93	FY94	FY95	FY96	FY97	FY98
Number of Activations	23	33	31	25	26	24	19
Number of Days Activated	23	33	31	25	33	29	22
Total Volume Treated (MG)	361	677	621	574	918	1092	792
Maximum Flow (mgd)	64	145	123	100	94	199	114
Minimum Flow (mgd)	0.01	0.69	0.08	0.09	1.88	0.63	0.76
Average Flow (mgd)	15.70	20.52	20.03	22.96	27.83	37.66	36.01
Total Rainfall (in/year)	41.18	48.82	45.00	37.40	42.55	48.79	50.87

Average flow is calculated by dividing the total volume treated by the number of days activated.

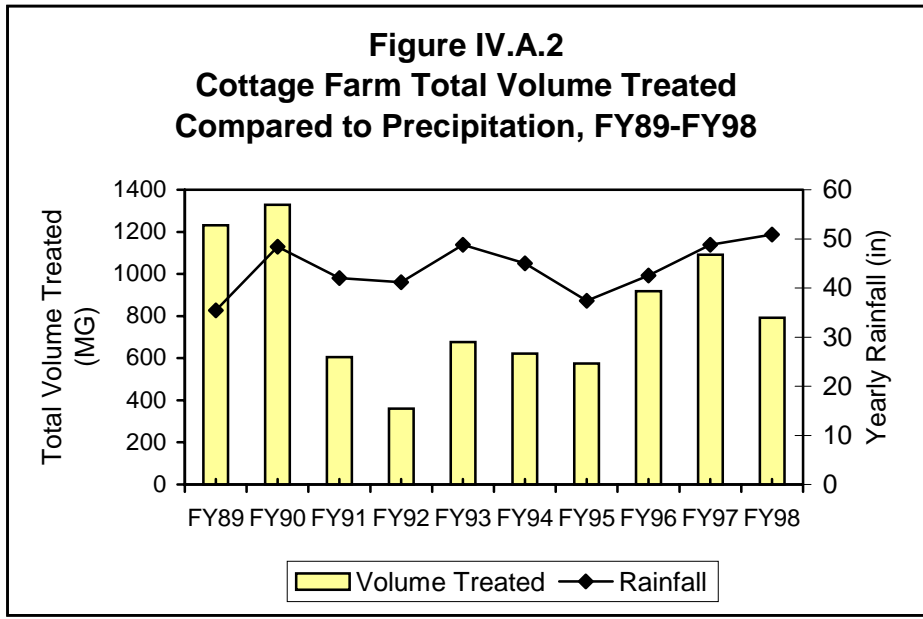
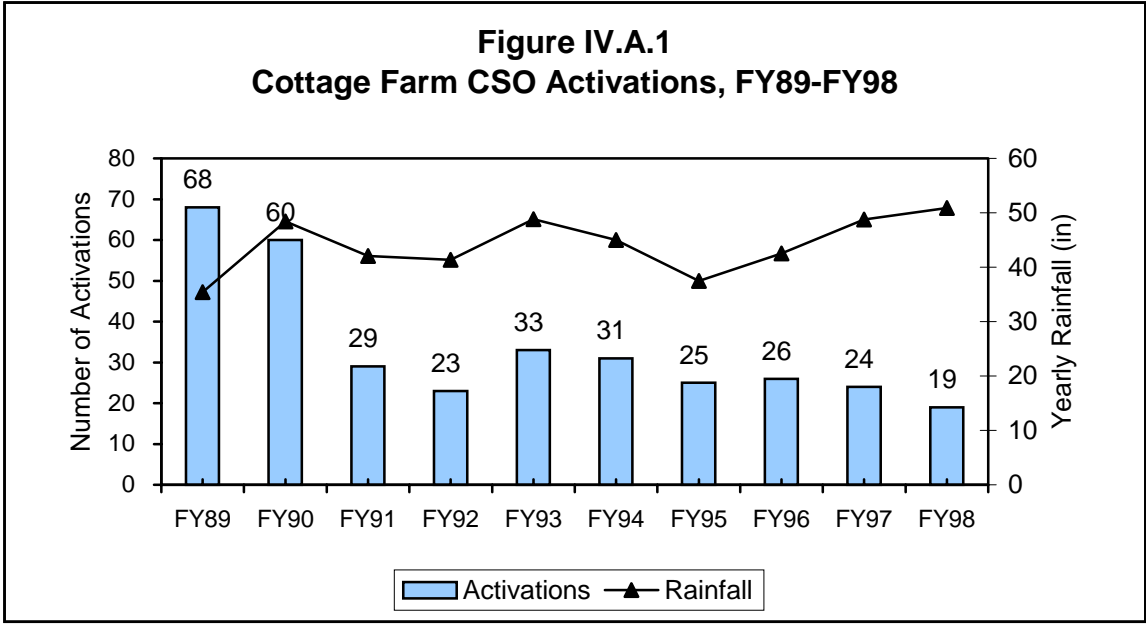
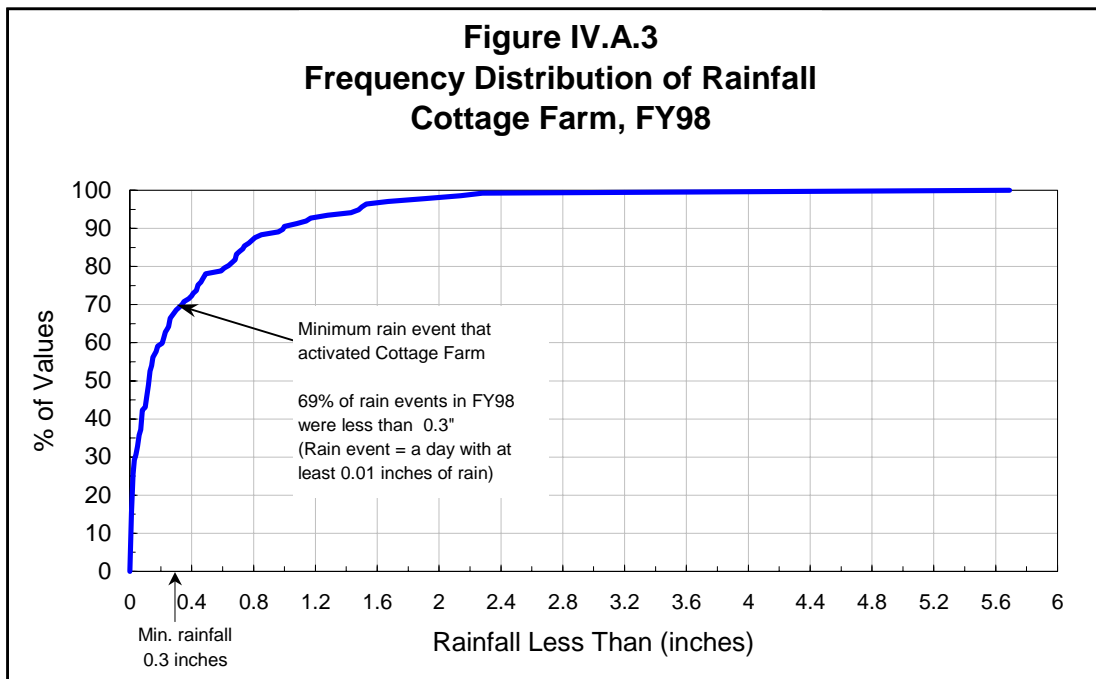

Figure IV.A.3 shows the frequency distribution of rainfall in FY98, and highlights the minimum amount of rainfall (0.3 inches of rain) at which the Cottage Farm facility activated in FY98. The frequency distribution considers all rain events, defined as days with at least 0.01 inches of rainfall.

According to the frequency distribution, activation of the Cottage Farm facility occurred during 31% of FY98 rain events.



IV.A.2 Conventional Parameters

Tables C-1 and C-2 of Appendix C contain data on conventional parameters in Cottage Farm influent and effluent, and Table IV.A.2 summarizes this data. Because this kind of treatment facility is not designed to remove such contaminants, and because of variability in the characteristics of combined sewage, there were times when the BOD and TSS loadings of the effluent measured higher than those of the influent.

There were two low pH measurements for Cottage Farm in FY98. However, there was only one violation of the NPDES permit, when pH fell below the minimum limit on June 16, 1998. Although on December 30, 1997 the reported measured pH was 6.0, there is some concern about the validity of the result.

**Table IV.A.2
Cottage Farm CSO Influent and Effluent Characteristics, FY98**

Parameter	Concentration (1)					
	Influent			Effluent		
	Min	Avg	Max	Min	Avg	Max
TSS	19	176	2350	12	58	124
BOD	<18	91	>178	13	43	83
Fecal Coliform (col/100 mL)				< 10	14	300
pH (units)				6.0		7.5

(1) Concentration expressed in mg/L except for pH and fecal coliform.

IV.A.3 Priority Pollutants

All Cottage Farm activations were also tested for priority pollutants. The results of that testing are presented in Appendix C, Tables C-3 and C-4. Metals were the most commonly detected priority pollutants, with copper, mercury, nickel, lead and zinc detected in all samples. Several other priority pollutants were detected in some, but not all, samples.

Table IV.A.3 summarizes average metals concentrations in Cottage Farm effluent in FY98.

	Average Concentration	Times Detected
	(ug/L)	
Cadmium	1.40	3 of 9
Copper	68.13	9 of 9
Mercury	0.26	10 of 10
Nickel	4.92	1 of 9
Lead	55.01	10 of 10
Zinc	116.68	9 of 9

IV.B Prison Point Combined Sewer Overflow Facility

IV.B.1 Activations

Activation data for the Prison Point CSO facility are summarized in Table IV.B.1 and Figures IV.B.1 and IV.B.2.

Unlike the Cottage Farm CSO facility, the Prison Point facility is not hydraulically connected to the Deer Island Treatment Plant, so increased pumping at Deer Island will not affect Prison Point activation. In addition, the Prison Point facility will activate during smaller rain events than the Cottage Farm facility (compare Figure IV.A.3 with Figure IV.B.3).

The volume treated at Prison Point in FY98 was roughly the same as in FY97. The volume treated during each of these years is significantly higher than in any of the previous years, even during years of comparable rainfall. This increase can be attributed to the high-intensity storms that occurred during FY97 and FY98.

Table IV.B.1 Prison Point CSO Activations Summary

	FY92	FY93	FY94	FY95	FY96	FY97	FY98
Number of Activations	29	26	26	26	24	26	32
Number of Days Activated	29	26	26	26	29	30	34
Total Volume Treated (MG)	429	269	449	460	445	926	958
Maximum Flow (mgd)	63	28	80	127	63	228	143
Minimum Flow (mgd)	1.08	1.63	3.01	1.63	1.24	1.50	2.00
Average Flow (mgd)	14.79	10.34	17.27	17.69	15.34	30.86	28.18
Total Rainfall (in/year)	41.18	48.82	45.00	37.40	42.55	48.79	50.87

Average flow is calculated by dividing the total volume treated by the number of days activated.

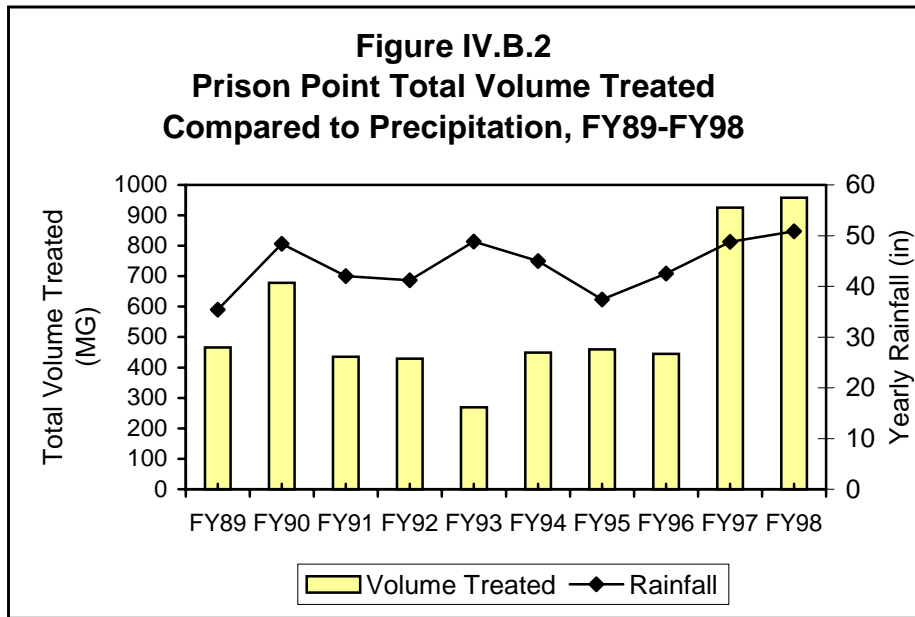
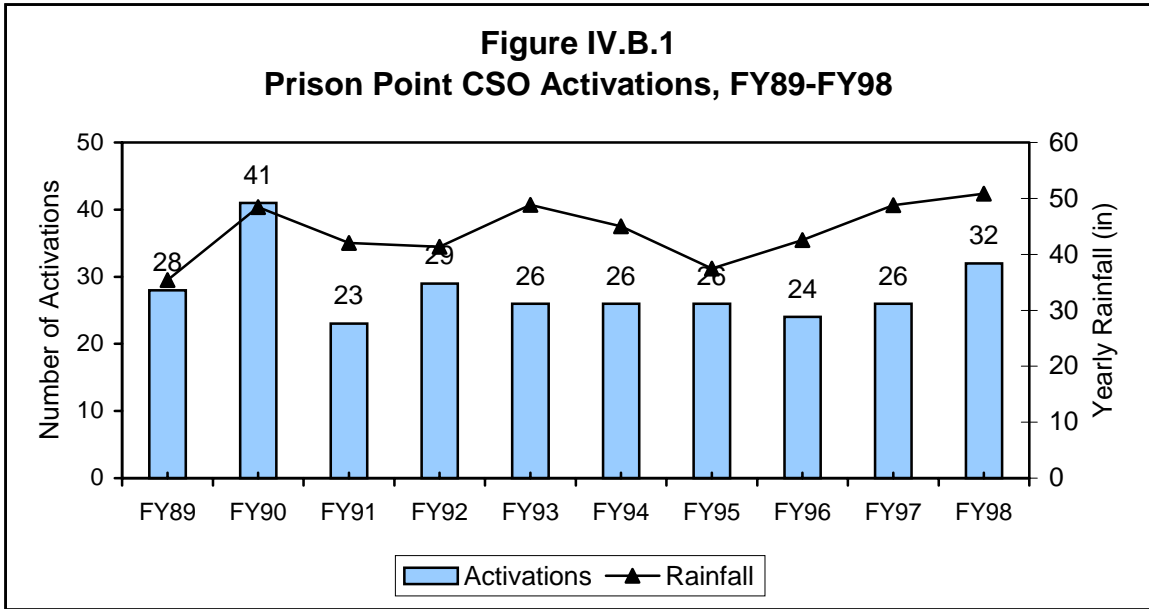
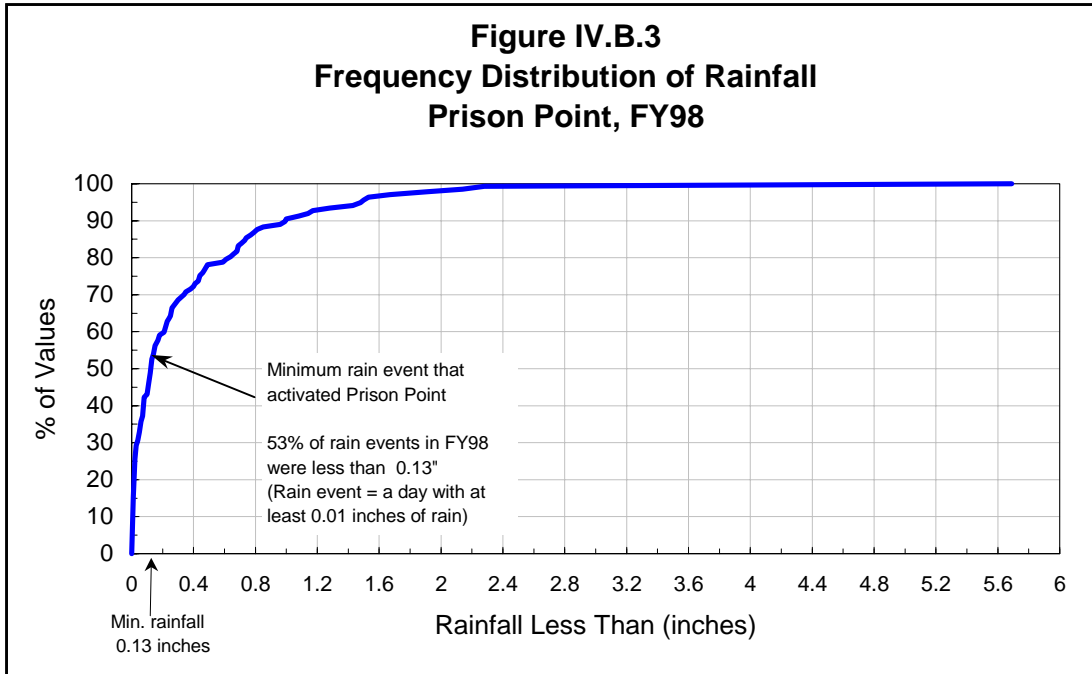

Figure IV.B.3 shows the frequency distribution of rainfall in FY98, and highlights the minimum amount of rainfall (0.13 inches of rain) at which the Prison Point facility activated. According to the frequency distribution, activation of the Prison Point facility occurred during 47% of FY98 rain events.



IV.B.2 Conventional Parameters

Conventional parameter data for Prison Point influent and effluent are provided in Appendix D Tables D-1 and D-2. Like the facility at Cottage Farm, this treatment facility is not designed to remove such contaminants.

There were no NPDES permit violations at Prison Point in FY98.

**Table IV.B.2
Prison Point CSO Influent and Effluent Characteristics, FY98**

Parameter	Concentration (1)					
	Influent			Effluent		
	Min	Avg	Max	Min	Avg	Max
TSS	16	199	869	22	84	235
BOD	<10	50	129	17	37	74
Fecal Coliform (col/100 mL)				<10	18	1400
pH (units)				6.7		7.5

(1) Concentration expressed in mg/L except for pH and fecal coliform.

IV.B.3 Priority Pollutants

The results of priority pollutant testing for Prison Point can be found in Tables D-3 and D-4 of Appendix D. As at Cottage Farm, metals were the most commonly detected priority pollutants, with copper, mercury, lead and zinc detected in all samples. Other priority pollutants were detected in some but not all samples.

Table IV.B.3 summarizes average metals concentrations in Prison Point effluent in FY98.

	Average Concentration	Times Detected
	(ug/L)	
Cadmium	1.08	1 of 10
Copper	61.52	10 of 10
Mercury	0.23	10 of 10
Nickel	6.61	4 of 10
Lead	95.95	10 of 10
Zinc	162.09	10 of 10

IV.C Somerville Marginal Combined Sewer Overflow Facility

IV.C.1 Activations

Table IV.C.1 and Figures IV.C.1 and IV.C.2 summarize activation information for the Somerville Marginal facility.

Recently, there has been increased attention to SSOs (sanitary sewer overflows). MWRA intensified its monitoring efforts at areas known to overflow when there is a measurable rainfall event. (See Section V for more information about SSOs.) As a result, MWRA has inspected its CSO facilities more frequently, even during lower intensity rainfall. In particular, the gravity CSO facilities, Somerville Marginal, Constitution Beach, Fox Point and Commercial Point, have been monitored more frequently. This improved monitoring of CSO facilities has captured short activations during low intensity rainfall; in previous years these activations may not have been recorded.

Table IV.C.1 Somerville Marginal CSO Activations Summary

	FY92	FY93	FY94	FY95	FY96	FY97	FY98
Number of Activations	48	45	34	28	28	28	30
Number of Days Activated	48	45	34	28	30	29	31
Total Volume Treated (MG)	89	90	72	49	80	142	128
Maximum Flow (mgd)	9	8	11	14	9	64	22
Minimum Flow (mgd)	0.003	0.10	0.01	0.16	0.25	0.13	0.09
Average Flow (mgd)	1.85	2.00	2.12	1.75	2.67	4.90	4.12
Total Rainfall (in/year)	41.18	48.82	45.00	37.40	42.55	48.79	50.87

Average flow is calculated by dividing the total volume treated by the number of days activated.

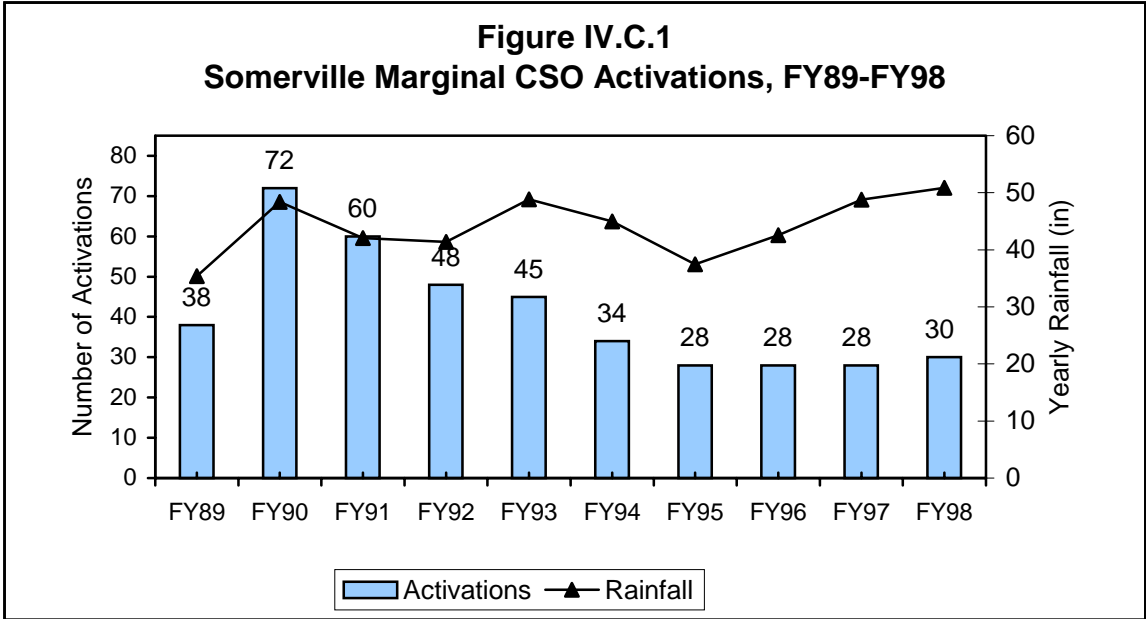

Figure IV.C.2 shows the volume treated at the Somerville Marginal gravity CSO facility over the past ten years. Somerville Marginal flow measurements in previous years were estimated low because the measurements did not include flows when the flow meters were malfunctioning. The Somerville Marginal facility responds to rainfall almost immediately, so that increased rainfall intensity will always result in increased volume treated.

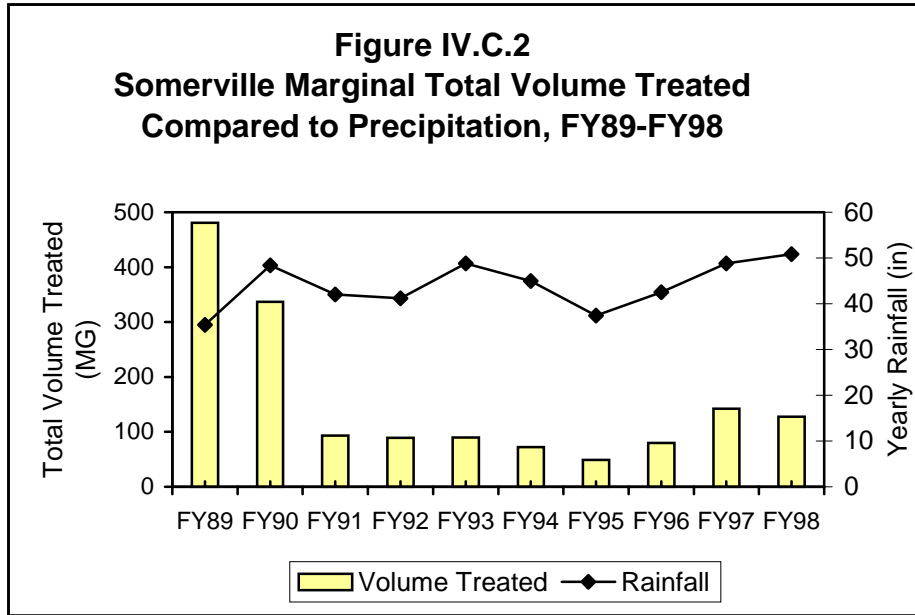
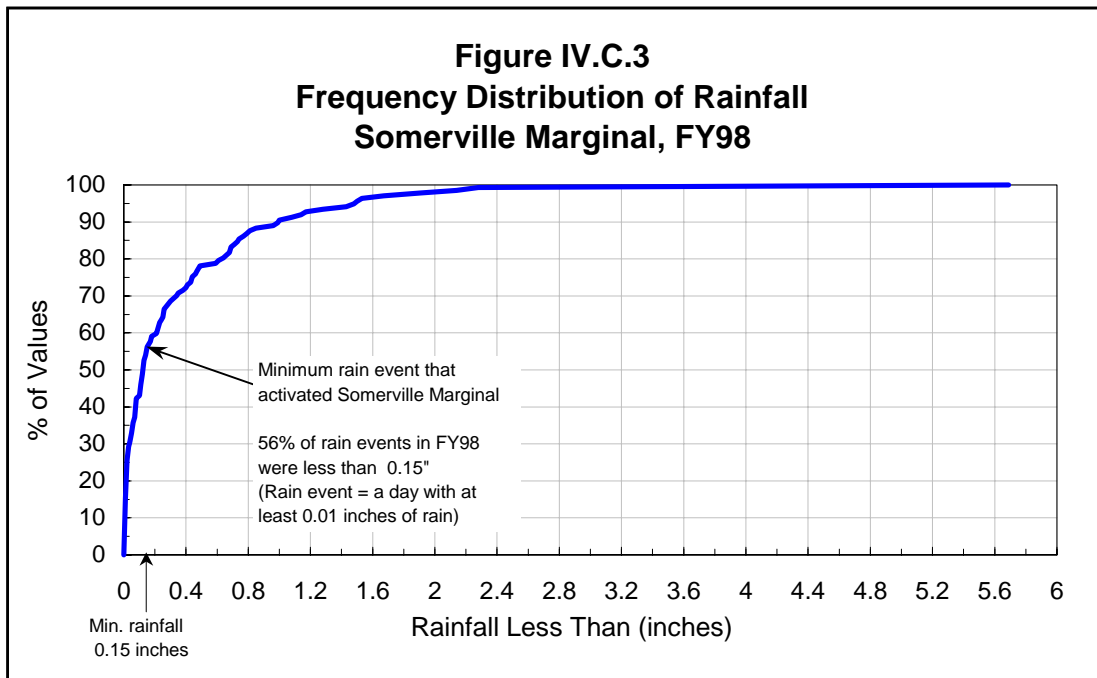

Figure IV.C.3 shows the frequency distribution of rainfall in FY98, and highlights the minimum rainfall event (0.15 inches of rain) at which the Somerville Marginal facility activated. According to the frequency distribution, activation of the Somerville Marginal facility occurred during 44% of FY98 rain events.



IV.C.2 Conventional Parameters

Somerville Marginal conventional parameter data are provided in Tables E-1 and E-2 of Appendix E, and are summarized in Table IV.C.2. The Somerville Marginal treatment facility, like Cottage Farm and Prison Point, is not designed to remove such contaminants.

There were no violations of the NPDES permit at Somerville Marginal in FY98.

Parameter	Concentration (1)					
	Influent			Effluent		
	Min	Avg	Max	Min	Avg	Max
TSS	25	74	190	18	80	244
BOD	12	26	76	<10	19	49
Fecal Coliform (col/100 mL)				< 10	12	130
pH (units)				6.7		7.2

(1) Concentration expressed in mg/L except for pH and fecal coliform.

IV.C.3 Priority Pollutants

The results of Somerville Marginal priority pollutant testing can be found in Appendix E, Tables E-3 and E-4. As at Prison Point, copper, mercury, lead, zinc and surfactants were detected in all samples, while several other priority pollutants were detected in some but not all samples.

Table IV.C.3 summarizes average metals concentrations in Somerville Marginal effluent in FY98.

Table IV.C.3 Somerville Marginal Metals, FY98

	Average Concentration (ug/L)	Times Detected
Copper	93.22	9 of 9
Mercury	0.30	7 of 9
Nickel	10.15	2 of 9
Lead	57.27	9 of 10
Zinc	137.64	9 of 9

IV.D Constitution Beach Combined Sewer Overflow Facility

IV.D.1 Activations

Activation data for the Constitution Beach facility are summarized in Table IV.D.1 and Figures IV.D.1 and IV.D.2.

The amount of flow passing through the Constitution Beach facility has increased in the last few years, as has the number of activations. The particularly low numbers in FY93-FY94 resulted from meter malfunctions. The increase in flows and activations during the years since then has been caused by increasing rainfall intensity and by changes to in-line storage practices. Some flow data for Constitution Beach may be inaccurate because the flow meters are affected by tidal flow. However, since FY95, trends show that the volume treated rises with increasing rainfall intensity.

As mentioned above, improved monitoring at the CSO facilities meant that shorter activations were recorded. For example, of the 20 activations reported for the Constitution Beach facility, five of them contributed less than 0.15 MG to the total volume treated.

Table IV.D.1 Constitution Beach CSO Activations Summary

	FY92	FY93	FY94	FY95	FY96	FY97	FY98
Number of Activations	12	4	8	12	13	16	20
Number of Days Activated	12	4	8	12	13	17	21
Total Volume Treated (MG)	10.94	1.57	0.69	6.80	7.94	11.32	10.52
Maximum Flow (mgd)	1.94	1.22	0.20	1.30	1.20	2.35	3.24
Minimum Flow (mgd)	0.23	0.10	0.01	0.20	0.21	0.14	0.06
Average Flow (mgd)	0.91	0.39	0.09	0.57	0.61	0.67	0.50
Total Rainfall (in/year)	41.18	48.82	45.00	37.40	42.55	48.79	50.87

Average flow is calculated by dividing the total volume treated by the number of days activated.

**Figure IV.D.1
Constitution Beach CSO Activations, FY90-FY98**

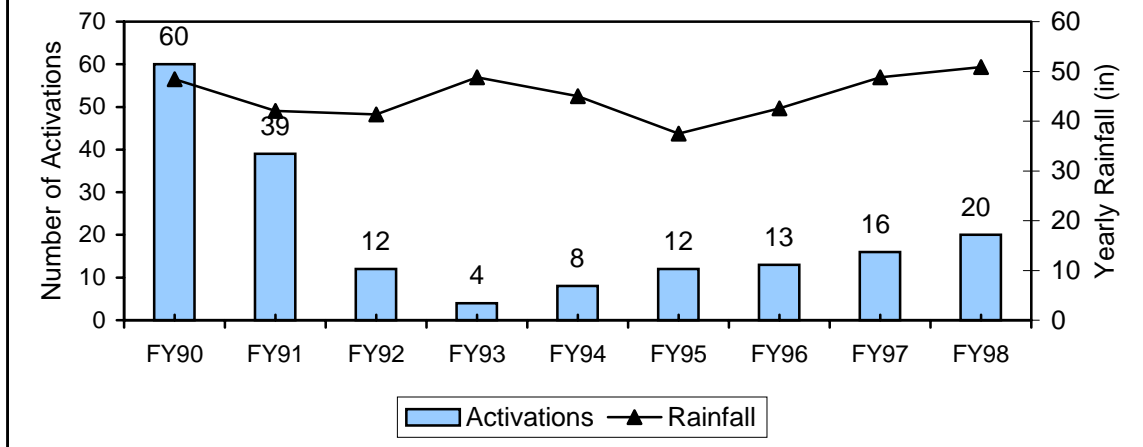

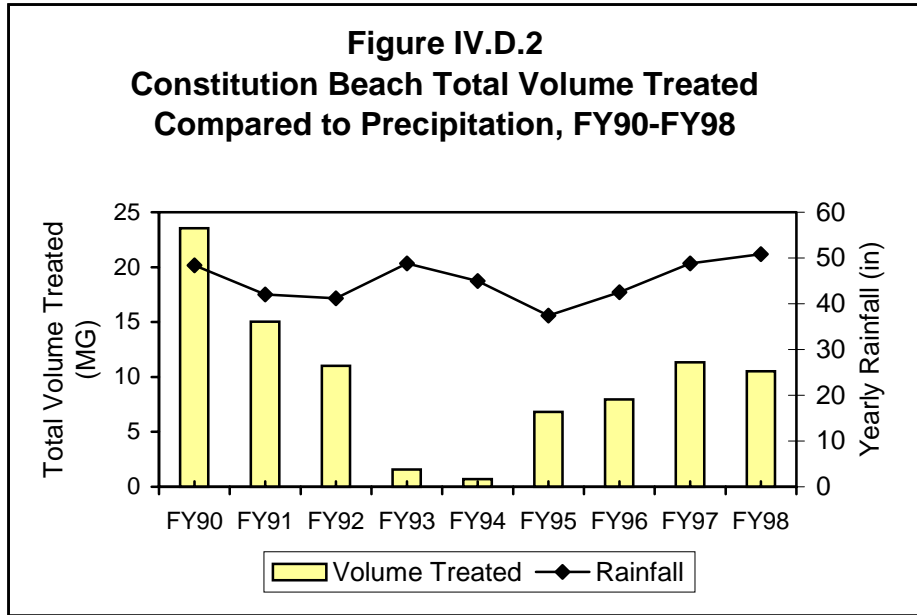
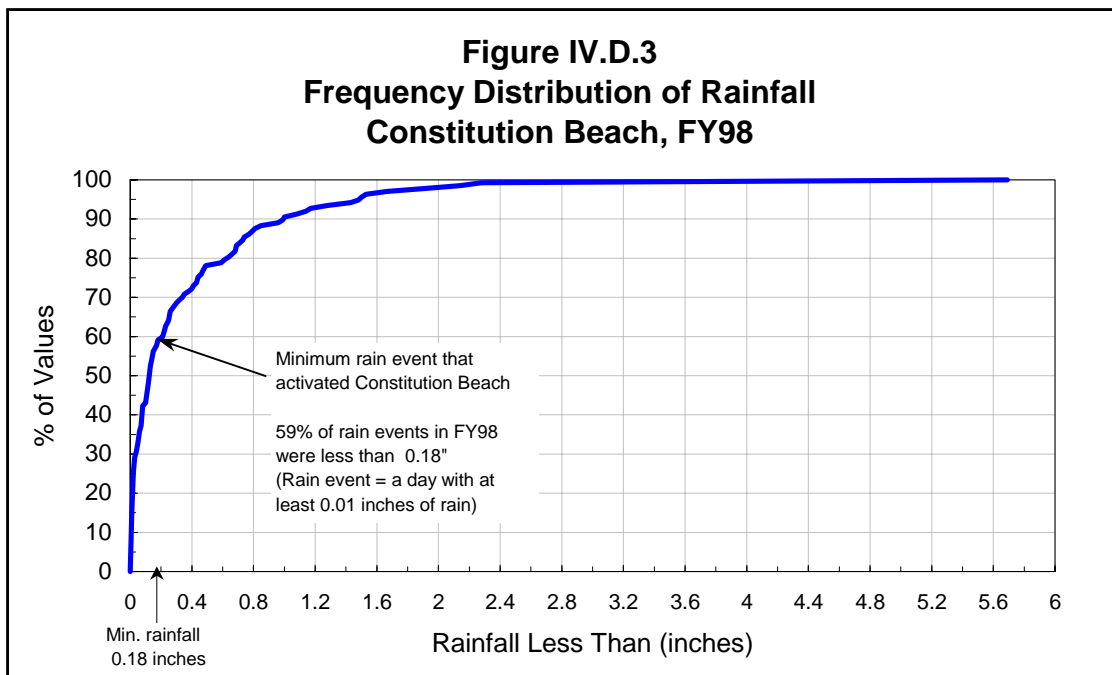

Figure IV.D.3 shows the frequency distribution of rainfall in FY98, and highlights the minimum point (0.18 inches of rain) at which the Constitution Beach facility activated. According to the frequency distribution, activation of the Constitution Beach facility occurred during 41% of FY98 rain events.



IV.D.2 Conventional Parameters

Conventional parameter data for the Constitution Beach facility are provided in Appendix F, Tables F-1 and F-2 and summarized in Table IV.D.2. As with the other CSO facilities, concentrations fluctuated a good deal in both influent and effluent.

Table IV.D.2						
Constitution Beach CSO Influent and Effluent Characteristics, FY98						
Parameter	Concentration (1)					
	Influent			Effluent		
	Min	Avg	Max	Min	Avg	Max
TSS	19	46.5	92	14	44	186
BOD	<6.5	14	33	<7.4	13	34
Fecal Coliform (col/100 mL)				<10	12	50
pH (units)				6.5		7.0

(1) Concentration expressed in mg/L except for pH and fecal coliform.

IV.E Fox Point Combined Sewer Overflow Facility

IV.E.1 Activations

Activation data for Fox Point are summarized in Table IV.E.1 and Figures IV.E.1 and IV.E.2.

The volume treated at Fox Point has been increasing since FY92-FY93, with the exception of FY95, when use of the facility was decreased due to repair work that required rerouting of flows.

Table IV.E.1 Fox Point CSO Activations Summary

	FY92	FY93	FY94	FY95	FY96	FY97	FY98
Number of Activations	22	21	20	4	12	16	21
Number of Days Activated	22	21	20	4	14	18	24
Total Volume Treated (MG)	38	37	76	24	97	154	166
Maximum Flow (mgd)	5	8	12	10	17	45	39
Minimum Flow (mgd)	0.40	0.36	0.40	1.50	1.09	0.26	0.17
Average Flow (mgd)	1.73	1.76	3.80	6.00	6.90	8.55	6.92
Total Rainfall (in/year)	41.18	48.82	45.00	37.40	42.55	48.79	50.87

Average flow is calculated by dividing the total volume treated by the number of days activated.

**Figure IV.E.1
Fox Point CSO Activations, FY91-FY98**

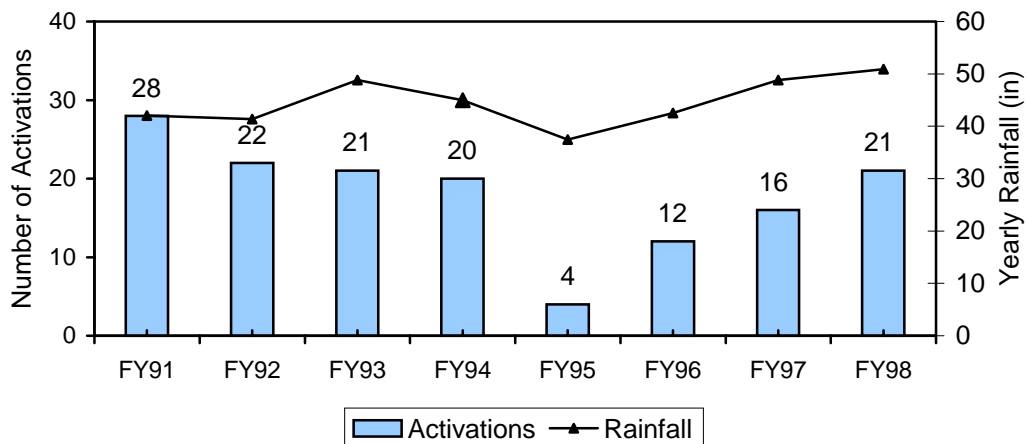

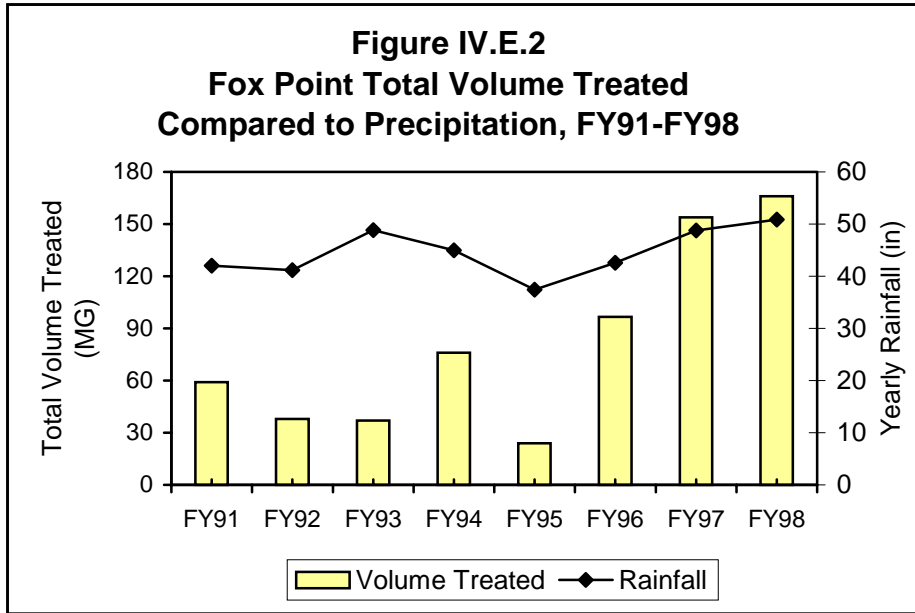
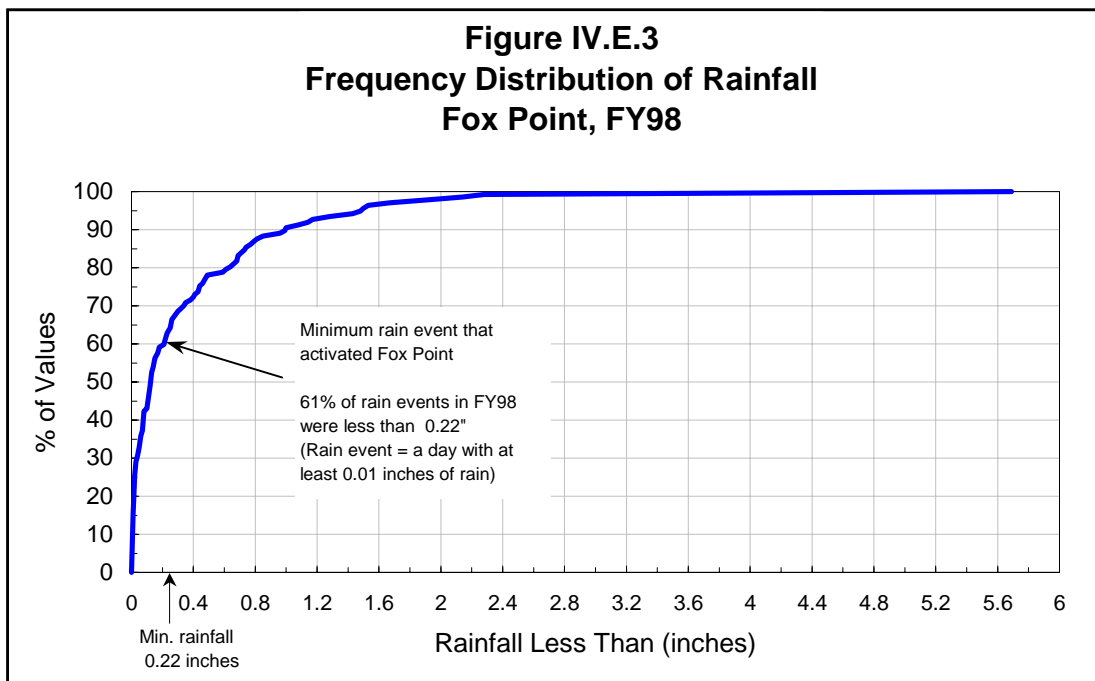

Figure IV.E.3 shows the frequency distribution of rainfall in FY98, and highlights the minimum rainfall event (0.22 inches of rain) at which the Fox Point facility activated. According to the frequency distribution, activation of the Fox Point facility occurred during 39% of FY98 rain events.



IV.E.2 Conventional Parameters

Conventional parameter data for the Fox Point CSO facility are provided in Appendix G Tables G-1 and G-2 and summarized in Table IV.E.2. Again, a wide range of values was reported for both influent and effluent.

Parameter	Concentration (1)					
	Influent			Effluent		
	Min	Avg	Max	Min	Avg	Max
TSS	24	91	230	5	84	300
BOD	19	45	100	<7	38	89
Fecal Coliform (col/100 mL)				<10	19	130
pH (units)				6.6		7.8

(1) Concentration expressed in mg/L except for pH and fecal coliform.

IV.F Commercial Point Combined Sewer Overflow Facility

IV.F.1 Activations

Commercial Point activation data are summarized in Table IV.F.1 and Figures IV.F.1 and IV.F.2.

The total recorded volume of flow treated in FY98, as reported in Table IV.F.1, would have been higher, but there was a meter malfunction on two days of high rainfall. A total of 1.14 inches of rain fell on April 23, 1998, and 1.67 inches of rain fell on June 30. The volume treated on these two days was not recorded, however, due to a meter malfunction. (See Table H-1 in Appendix H.) It is estimated that the volume treated in FY98 is comparable to the volume treated in FY97.

Table IV.F.1 Commercial Point CSO Activations Summary

	FY92	FY93	FY94	FY95	FY96	FY97	FY98
Number of Activations	33	28	25	19	13	23	25
Number of Days Activated	33	28	25	19	14	24	28
Total Volume Treated (MG)	80	77	93	56	70	158	125
Maximum Flow (mgd)	11	10	17	17	18	54	25
Minimum Flow (mgd)	1.00	0.10	0.21	0.15	0.06	0.19	0.14
Average Flow (mgd)	2.42	2.76	3.72	2.94	5.01	6.59	4.46
Total Rainfall (in/year)	41.18	48.82	45.00	37.47	42.55	48.79	50.87

Average flow is calculated by dividing the total volume treated by the number of days activated.

**Figure IV.F.1
Commercial Point CSO Activations, FY92-FY98**

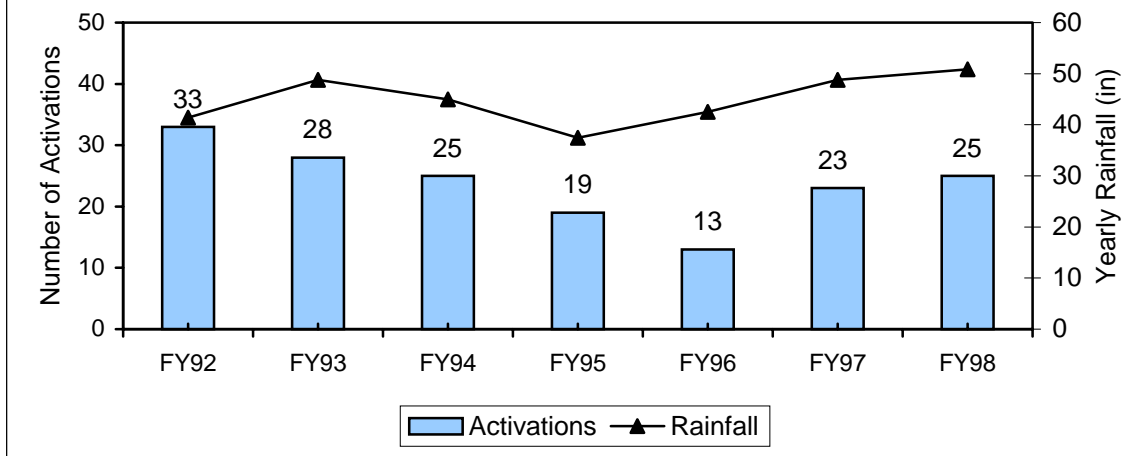

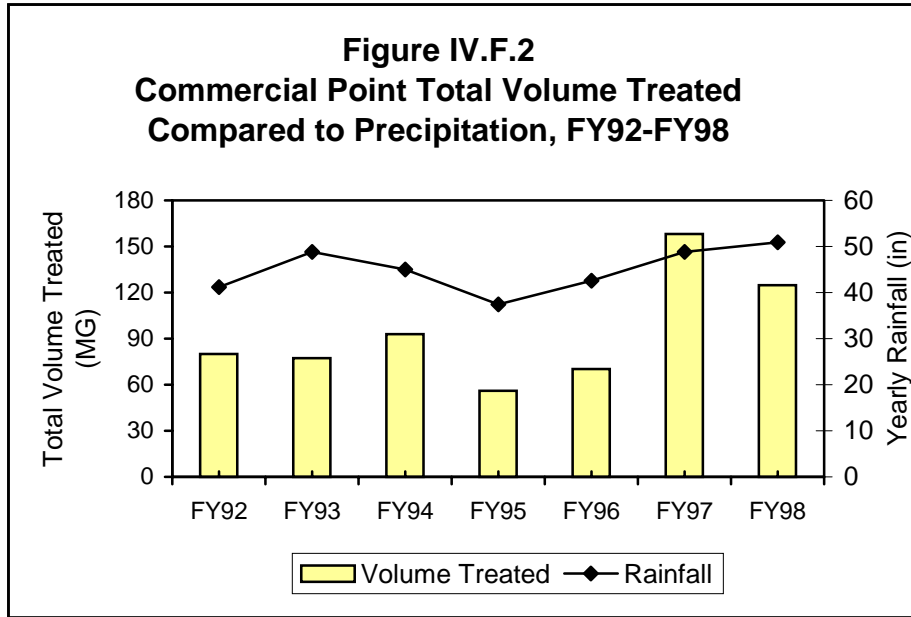
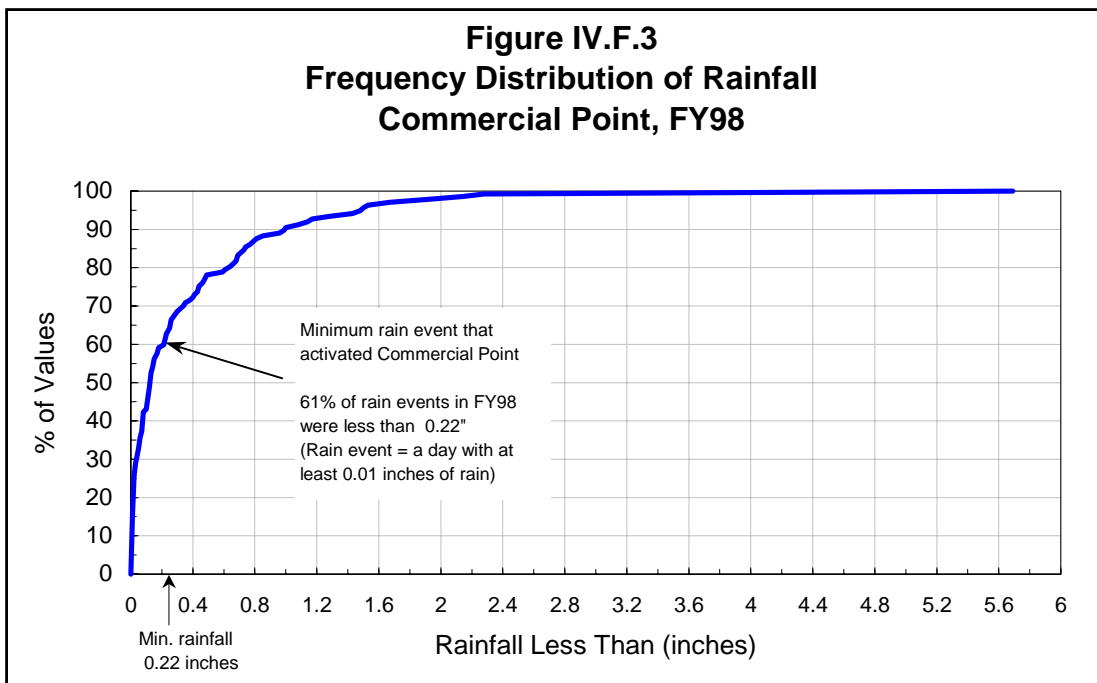

Figure IV.F.3 shows the frequency distribution of rainfall in FY98, and highlights the minimum rainfall event (0.22 inches of rain) at which the Commercial Point facility activated. According to the frequency distribution, activation of the Commercial Point facility occurred during 39% of FY98 rain events.



IV.F.2 Conventional Parameters

Commercial Point conventional parameter data are provided in Appendix H Tables H-1 and H-2. Again, a wide range of values was reported for both influent and effluent. There was only one violation of the NPDES permit for Commercial Point in FY98, for pH.

Parameter	Concentration (1)					
	Influent			Effluent		
	Min	Avg	Max	Min	Avg	Max
TSS	22	161	1230	15	121	418
BOD	<17.1	45	445	<6.5	21	109
Fecal Coliform (col/100 mL)				<10	19	3900
pH (units)				6.0		7.9

(1) Concentration expressed in mg/L except for pH and fecal coliform.

V Transport Systems

V.A North System

V.A.1 Headworks Choking

Figure V.A.1 shows the number of hours of maintenance-related choking and rain-related choking at the remote headworks over the last seven years.

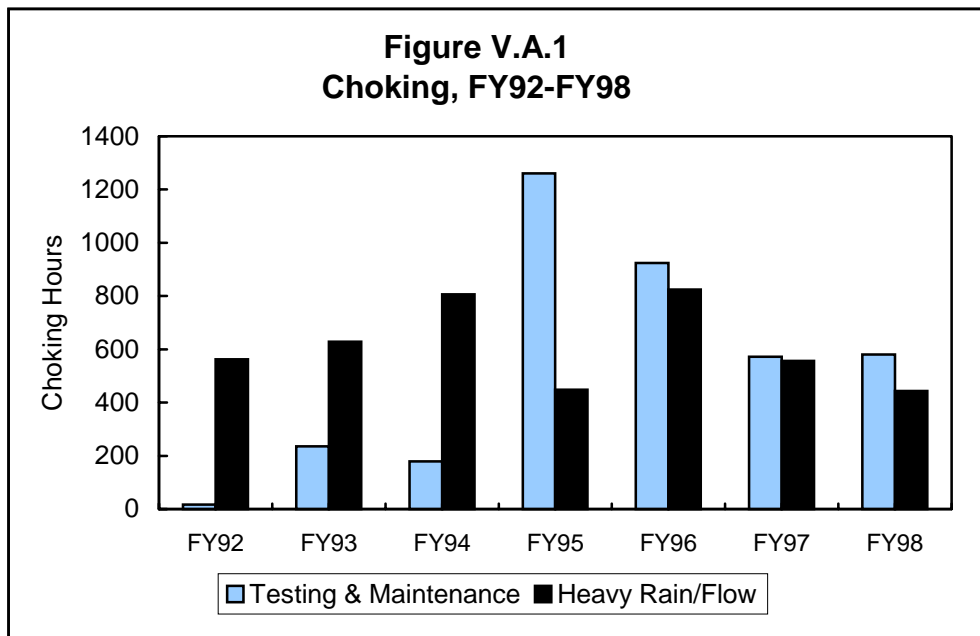
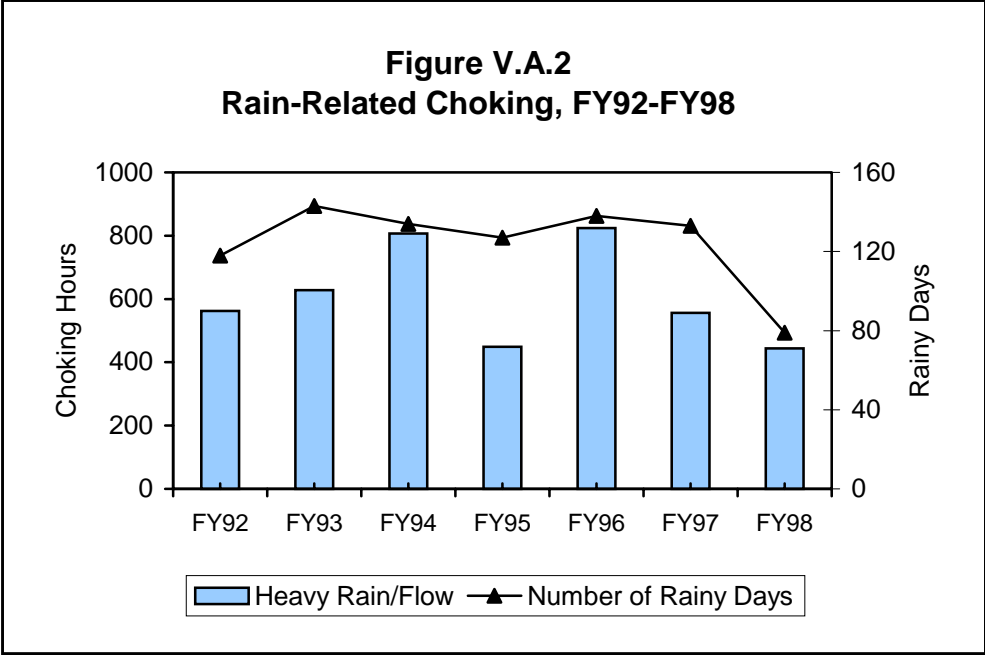
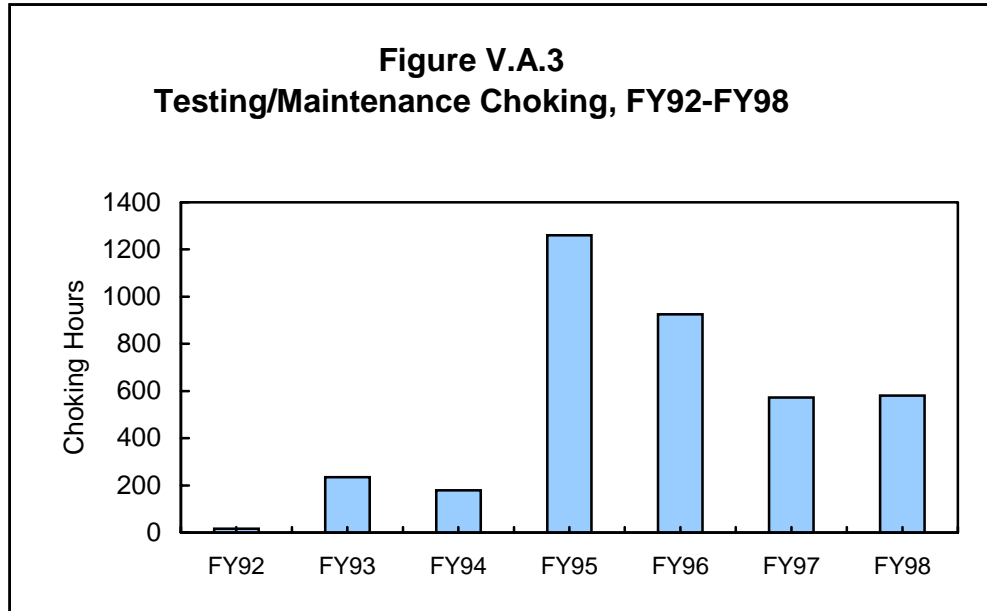

Figure V.A.2 shows the influence of the number of rainy days in a year on the hours of rain-related choking in that year. A rainy day is defined as a day with at least 0.1 inches of rainfall. As this figure shows, FY98 had fewer rainy days than in previous years, despite the fact that there was more rainfall in FY98. In FY98, rain-related choking occurred mostly in May and June.



Choking for maintenance purposes is plotted in Figure V.A.3. Maintenance choking peaked in FY95 due to the maintenance and testing involved in bringing the new primary treatment plant on-line. The number of hours of maintenance-related choking has continued to be fairly high in the past few years because of maintenance and testing related to the startup of the new primary and secondary treatment plants. In FY98, of the approximately 580 choking hours related to testing and maintenance, 442 hours were due to testing.

Although testing-related choking hours can be expected to decrease considerably in the future, we expect that FY99 and FY00 will still have a significant number of choking hours due to testing of systems associated with the third battery of secondary treatment and the new 9.5-mile outfall tunnel.



V.A.2 Sanitary Sewer Overflows

Sanitary sewer overflows, which occur when the transport system is overwhelmed during extreme rainfall events, are monitored by MWRA visually and with meters in both the North System and the South System. Table V.A.1 lists the number of recorded overflows at several locations in the North System, comparing FY98 with the previous fiscal year. Note that the number of overflows refers to the number of events, rather than the number of days; one overflow can last a number of days. This list includes only overflows at MWRA-owned overflow areas. There are also overflows for which the local municipalities are responsible that MWRA monitors less frequently, unless requested to do so by municipalities, or notified of a problem by concerned citizens. A list of all the known overflow locations monitored by MWRA, including both MWRA and municipal overflows, is provided in Appendix J, Table J-5.

Note that SSOs (sanitary sewer overflows) differ from CSOs (combined sewer overflows) in that CSO relief points are pipes that were specifically designed to relieve the sewer system. When the

system becomes overloaded, these pipes discharge combined sewage and stormwater into a receiving body of water, such as the Charles River. SSOs, on the other hand, are weak points in the system, such as manholes, which will overflow during heavy rain events.

Location	Number of Overflows	
	<u>FY97</u>	<u>FY98</u>
Section C Medford	3	2
Section 107 Medford	3	3
Section 91B Medford (Siphon)	1	0
Section 43.5 Medford	1	0
Section B Cambridge	1	1
Section 113 Winchester	1	1
Section 80 Arlington	1	1

V.B South System

V.B.1 Sanitary Sewer Overflows

Table V.B.1 lists the observed overflows in the South System.

Location	Number of Overflows	
	<u>FY97</u>	<u>FY98</u>
Section 126 Weymouth Smelt Brook	8	8
Section 126 Weymouth (Manhole)	5	0
Section 128 Braintree (Siphon)	1	0

Appendix A

Table A-1 Deer Island Treatment Plant Operations Summary, Fiscal Year 1998

Table A-2 Deer Island Influent Characterization, Fiscal Year 1998

Table A-3 Deer Island Influent Loadings, Fiscal Year 1998

Table A-4 Deer Island Effluent Characterization, Fiscal Year 1998

Table A-5 Deer Island Effluent Loadings, Fiscal Year 1998

Table A-1 Deer Island Treatment Plant Operations Summary, Fiscal Year 1998

	JULY	AUG	SEPT	OCT	NOV	DEC	JAN	FEB	MAR	APR	MAY	JUNE	MIN	AVG	MAX
INFLUENT															
FLOW (mgd)*															
AVERAGE	184.8	191.4	182.5	180.1	249.8	224.6	307.3	347.9	349.8	345.3	466.7	524.3		296.2	
% of total flow from South System (April-June)										20%	29%	30%			
MINIMUM	169.0	169.1	159.9	158.6	196.5	189.7	214.6	240.7	280.3	287.5	235.2	297.1	158.6		
MAXIMUM	207.7	301.2	228.1	261.9	394.6	339.5	627.2	777.9	693.4	557.7	853.4	917.3			917.3
TEMP (deg F)															
AVERAGE	69.6	71.3	71.1	69.1	62.8	59.9	55.4	53.9	54.7	57.9	60.2	63		62.41	
MINIMUM	66.2	68.7	69.1	67.3	56.1	53.6	45.9	47.1	51.1	54.5	53.1	56.3	45.9		
MAXIMUM	77	77	77	73	68.4	64.4	58.6	59.7	59.9	61.8	66.2	66.7			77
pH (units)															
AVERAGE	6.7	6.8	6.8	6.7	6.8	6.7	6.7	6.7	6.7	6.9	6.8	6.8		6.76	
MINIMUM	6.4	6.5	6.6	6.5	6.4	6.6	6.4	6.3	6.4	6.7	6.6	6.6	6.3		
MAXIMUM	7	7.1	7	7.1	7.1	7	7.1	7	7	7.1	7.1	7.5			7.5
CONVENTIONAL PARAMETERS (mg/L)															
TOTAL SOLIDS															
AVERAGE	1517	1522	1570	1600	1314	1308	1149	1088	1002	1152	1078	1082		1281.83	
MINIMUM	972	876	1030	924	700	1000	600	528	596	812	648	472	472		
MAXIMUM	2360	2520	2600	2520	2470	1710	1880	1750	2220	1560	1590	1500			2600
VOLATILE SOLIDS															
AVERAGE	420	438	661	406	294	303	258	260	236	340	309	325		354.17	
MINIMUM	260	164	84	212	188	204	140	172	132	204	124	128	84		
MAXIMUM	544	764	8290	612	392	364	364	444	348	640	500	476			8290
SETTLABLE SOLIDS (mL/L)															
AVERAGE	7.7	7.3	8.1	8.8	6.1	6.7	6	6.6	6.3	4.4	3.5	4.3		6.32	
MINIMUM	4	4.5	2.5	1.4	3.5	0.8	2	2.2	0.2	0.2	0.1	0.2	0.1		
MAXIMUM	12	13	11	20	9	14	13	12	10	10	8	8.5			20
TVSS															
AVERAGE	143	149	661	157	117	125	98	95	90	141	138	107		168.42	
MINIMUM	14	110	84	62	78	58	51	56	56	28	27	35	14		
MAXIMUM	240	232	8290	320	154	154	216	150	126	250	304	165			8290

Table A-1 Deer Island Treatment Plant Operations Summary, Fiscal Year 1998, cont.

	JULY	AUG	SEPT	OCT	NOV	DEC	JAN	FEB	MAR	APR	MAY	JUNE	MIN	AVG	MAX
INFLUENT															
TSS **															
AVERAGE	173	178	168	183	137	144	116	113	106	139	137	103		141.42	
MINIMUM	83	120	96	76	94	70	57	68	72	35	32	46	32		
MAXIMUM	278	330	256	382	176	176	248	216	155	254	336	167			382
BOD **															
AVERAGE	190	175	200	209	152	152	114	115	112	124	103	94		145.00	
MINIMUM	115	114	165	102	99	71	66	46	73	61	38	31	31		
MAXIMUM	252	245	298	302	212	216	153	189	187	181	247	149			302
CBOD															
AVERAGE	159	144	157	170	115	122	82	80	75	101	88	83		114.67	
MINIMUM	105	63.2	119	98.8	79.4	71	46.7	36.8	39.9	58.3	17.6	27.3	17.6		
MAXIMUM	248	312	192	237	207	148	116	138	159	138	165	128			312
COD															
AVERAGE	432	122	425	448	341	347	262	262	226	325	302	272		313.67	
MINIMUM	248	242	333	268	261	86	154	124	157	176	129	77	77		
MAXIMUM	626	593	495	361	446	468	365	421	336	581	518	427			626
TOC															
AVERAGE	106	88.3	97.4	100.5	73.4	71.9	49.7	65.2	41.7	50.4	ND	ND		74.45	
MINIMUM	97.7	77.1	84.3	82	68.5	54.9	36.6	45.9	24	50.4	ND	ND	24		
MAXIMUM	120	94.9	112	132	78.7	86	64.2	86.1	52.1	50.4	ND	ND			132
FOG															
AVERAGE	29.3	33.2	45.7	28.4	29	27.7	19.6	22.4	20.7	61.4	19.5	17.6		29.54	
MINIMUM	25.1	25.6	22.2	11.1	18.6	7	11.6	13	15.5	25	7	7	7		
MAXIMUM	39.5	43.2	106	42.2	53.7	40.4	31.7	34.2	24.5	108	39.4	28.3			108
CHLORIDE															
AVERAGE	599	595	602	671	521	537	482	441	394	417	402	401		505.17	
MINIMUM	352	236	340	390	215	378	241	211	196	260	204	94	94		
MAXIMUM	1060	1040	1210	1140	1140	713	963	815	1120	708	625	611			1210

Table A-1 Deer Island Treatment Plant Operations Summary, Fiscal Year 1998, cont.

	JULY	AUG	SEPT	OCT	NOV	DEC	JAN	FEB	MAR	APR	MAY	JUNE	MIN	AVG	MAX
INFLUENT															
TCOLIFORM (col/100ml)															
GEO MEAN (E+06)	13.25	55.97	59.57	61.32	40.89	36.25	11.03	7.08	6.4	14.86	6.34	14.96		19.39	
MINIMUM (E+06)	5	23	42	32	26	8	4.5	3	2.4	3.6	0.4	2	0.4		
MAXIMUM (E+06)	200	107	84	106	92	80	16	21	14	217	41.3	155			217
FCOLIFORM (col/100ml)															
GEO MEAN (E+06)	1.1	4.5	6.43	5.35	2.64	2	0.7	0.32	0.35	0.55	0.215	1.27		1.22	
MINIMUM (E+06)	5	2.1	3.9	3.6	1.6	0.6	0.2	0.05	0.14	0.28	0.02	0.1	0.02		
MAXIMUM (E+06)	7.9	7	10.6	8.4	4.8	3.2	1.6	0.85	0.72	1.35	2.5	4.4			10.6
NUTRIENTS (mg/L)															
AMMONIA															
AVERAGE	19.06	16.73	20.40	21.46	16.98	14.87	10.96	8.87	9.74	14.83	8.63	10.82		14.45	
MINIMUM	18.30	11.00	17.40	19.80	15.50	9.34	8.88	4.78	6.82	13.40	6.97	5.26	4.78		
MAXIMUM	21.30	19.00	23.10	22.80	18.80	17.20	13.20	13.30	11.80	15.60	11.50	16.80			23.1
NITRITES															
AVERAGE	0.01	0.01	0.07	0.01	0.08	0.15	0.11	0.12	0.11	0.01	0.25	0.07		0.08	
MINIMUM	0.01	0.01	0.01	0.01	0.01	0.01	0.05	0.07	0.07	0.01	0.02	0.01	0.01		
MAXIMUM	0.01	0.01	0.14	0.01	0.28	0.38	0.20	0.15	0.16	0.02	0.46	0.18			0.46
NITRATES															
AVERAGE	0.01	0.01	0.01	0.02	0.02	0.31	1.21	1.01	0.73	0.05	0.48	0.46		0.36	
MINIMUM	0.01	0.01	0.01	0.01	0.01	0.01	0.38	0.49	0.30	0.01	0.01	0.01	0.01		
MAXIMUM	0.02	0.01	0.01	0.04	0.03	1.06	1.95	1.49	1.41	0.10	0.88	1.36			1.95
ORTHOPHOSPHATE															
AVERAGE	2.47	2.16	2.59	2.97	2.06	1.81	1.13	0.94	1.04	1.65	0.93	1.41		1.76	
MINIMUM	2.30	1.26	2.09	2.83	1.65	0.88	0.88	0.49	0.82	1.48	0.70	0.61	0.49		
MAXIMUM	2.58	2.60	2.88	3.13	2.55	2.31	1.40	1.38	1.23	1.94	1.31	2.46			3.13
TKN															
AVERAGE	34.12	31.25	32.48	34.12	27.83	26.14	23.93	19.40	22.73	25.73	16.53	22.20		26.37	
MINIMUM	31.60	30.60	30.30	32.70	26.20	21.10	22.10	13.60	19.70	24.90	15.60	14.70	13.6		
MAXIMUM	37.70	31.50	35.00	35.90	30.00	28.60	25.00	30.90	28.60	26.40	18.40	30.90			37.7
TOTAL PHOSPHORUS															
AVERAGE	4.60	4.46	4.74	4.74	4.10	3.95	3.08	2.69	3.10	3.86	2.83	2.24		3.70	
MINIMUM	4.36	4.23	4.07	4.15	3.74	2.59	2.48	1.80	2.45	3.70	2.55	2.24	1.8		
MAXIMUM	5.19	4.79	5.29	5.03	4.75	4.61	3.80	3.70	3.56	4.12	3.04	2.24			5.29
TPH (IR)															
AVERAGE	2.62	3.79	6.27	8.14	4.8	2.47	3.77	1.78	1.09	1	6.2	1.49		3.62	
MINIMUM	2.03	1.79	4.74	2.79	2.62	1.56	3.23	1.49	1	1	5.2	1	1		
MAXIMUM	3.51	5.34	8.04	13.5	9.28	2.99	4.64	2.01	1.26	1	7.2	1.87			13.5

Table A-1 Deer Island Treatment Plant Operations Summary, Fiscal Year 1998, cont.

	JULY	AUG	SEPT	OCT	NOV	DEC	JAN	FEB	MAR	APR	MAY	JUNE	MIN	AVG	MAX
EFFLUENT															
FLOW (mgd)															
AVERAGE	184.8	191.4	182.5	180.1	249.8	224.6	307.3	347.9	349.8	345.1	466.7	524.2		296.18	
MINIMUM	169	169.1	159.9	158.6	196.5	189.7	214.6	241.1	280.4	287.5	235.2	297.1	158.6		
MAXIMUM	207.7	301.2	228.1	261.9	394.6	339.5	627.2	777.9	693.4	555.9	853.4	917.3			917.3
TEMP (deg F)															
AVERAGE	70.4	71.5	71	67.2	63.9	59.9	55.8	54.6	54.9	58.3	60.9	64.7		62.76	
MINIMUM	66	68	67.3	19.9	60.8	53.2	45	49.8	51.6	56.3	56.3	62.8	19.9		
MAXIMUM	77	73.2	72.1	72	77	63	58.1	56.9	57.2	60.3	67	68.7			77
pH (units)															
AVERAGE	6.8	6.5	6.5	6.4	6.5	6.6	6.5	6.6	6.6	6.6	6.6	6.6		6.57	
MINIMUM	6.3	6.3	6.2	6.2	6.2	6.3	6	6.3	6.4	6.5	6.3	6.4	6		
MAXIMUM	7.1	7	6.8	6.7	6.8	6.8	6.8	6.9	6.8	6.8	6.8	7.3			7.3
CONVENTIONAL PARAMETERS (mg/L)															
TOTAL SOLIDS															
AVERAGE	1526	1523	1561	1529	1305	1284	1166	1102	963	979	968	853		1229.92	
MINIMUM	1060	1040	1040	788	824	952	672	556	500	628	520	524	500		
MAXIMUM	2300	2240	2560	2460	2780	1720	2140	1690	1860	2130	1590	1240			2780
VOLATILE SOLIDS															
AVERAGE	308	323	284	244	208	189	182	177	162	156	191	182		217.17	
MINIMUM	212	208	164	112	128	148	96	124	96	72	102	88	72		
MAXIMUM	464	596	636	404	336	264	272	256	268	356	376	304			636
SETTLEABLE SOLIDS (mL/L)															
AVERAGE	0.1	0.2	0.1	0.1	0.4	0.2	0.2	0.3	0.2	0.1	0.2	0.1		0.18	
MINIMUM	0.1	0.1	0.1	0.1	0.1	0.1	0.1	0.1	0.1	0.1	0.1	0.1	0.1		
MAXIMUM	0.2	0.8	1	0.2	7	0.5	0.5	1.3	2	0.2	1.6	0.2			7
TVSS															
AVERAGE	34.5	26.4	25.9	17	30.3	24.2	19.9	19.4	162	10.7	12.5	14		33.07	
MINIMUM	21	14	11	7	11	10	7	6	96	4	3	4	3		
MAXIMUM	49	42	41	32	120	42	40	40	268	19	35	40			268
TSS															
AVERAGE	41.8	31.7	29.2	20.5	36.1	27.1	24.7	24.3	22.6	13.2	15.3	17.7		25.35	
MINIMUM	25	16	10	9	12	13	9	8	11	6	4.3	5.3	4.3		
MAXIMUM	59	58	47	41	140	41	58	68	50	38	41	47			140

Table A-1 Deer Island Treatment Plant Operations Summary, Fiscal Year 1998, cont.

	JULY	AUG	SEPT	OCT	NOV	DEC	JAN	FEB	MAR	APR	MAY	JUNE	MIN	AVG	MAX
EFFLUENT															
BOD															
AVERAGE	94.5	48.3	46.8	34.7	50.6	33.7	34.5	35.5	26.2	18.4	19.6	23.1		38.83	
MINIMUM	42.8	32.3	24.5	18.4	19.7	21	18.7	16.3	12	7.8	8.6	8.3	7.8		
MAXIMUM	127	86.4	66.8	70.4	216	49.6	63.6	58.3	49.6	34.9	36	91			216
CBOD															
AVERAGE	92	42.7	35.5	27.9	46.8	29.1	27.3	27.9	19.9	10.8	16.6	18.7		32.93	
MINIMUM	57.5	24.1	20.4	15.3	18.5	18.7	19.7	15.8	6.9	5	6.7	6.7	5		
MAXIMUM	111	66.7	48.3	55.6	156	41.7	36.1	45.4	37.9	27.2	29.6	71.8			156
COD															
AVERAGE	242	156	142	129	158	125	114	113	88	74	83	86		125.83	
MINIMUM	162	119	99	91	95	81	49	85	57	54	53	56	49		
MAXIMUM	288	223	176	171	465	150	159	147	130	115	231	264			465
TOC															
AVERAGE	72.2	42.5	37.5	36.1	30.4	34.7	30.1	31.1	22.2	16.7	24	22.4		33.33	
MINIMUM	63.1	36.8	34.8	29.8	28.5	26.2	26.6	22.2	18.4	16	23.4	19.8	16		
MAXIMUM	76.8	50	39.2	41.6	32.4	38.6	32.2	36.3	29.1	18	24.7	24.9			76.8
FOG															
AVERAGE	21	14.7	11.7	8.4	13	7.9	8.3	11.1	10.7	7.1	7.1	9.2		10.85	
MINIMUM	9.7	7	7	7	7	7	7	5	7	7	7	4	4		
MAXIMUM	29.3	30.4	25	14.4	24.8	10.4	9.7	23.4	24.2	7.7	7.2	14.8			30.4
CHLORIDE															
AVERAGE	2.24	694	693	741	581	589	554	494	427	444	421	360		500.02	
MINIMUM	1.11	461	432	504	355	409	317	208	195	264	219	202	1.11		
MAXIMUM	5.03	1020	1220	1580	1420	927	1130	780	997	1000	752	477			1580
TCOLIFORM (col/100ml)															
GEO MEAN	120	80	68	88	62	27	36	42	21	65	104	224		63.89	
MINIMUM	9	5	5	6	5	5	10	5	5	6	14	16	5		
MAXIMUM	24301	2472771	2466	629745	5337	3429	2204	1032	107	1166	2786	4486			2,472,771
FCOLIFORM (col/100ml)															
GEO MEAN	8	9	9	10	9	6	6	6	5	5	7	11		7.33	
MINIMUM	5	5	5	5	5	5	4	5	4	5	5	5	4		
MAXIMUM	1875	50993	292	26134	2291	21	24	39	8	7	24	448			50,993

Table A-1 Deer Island Treatment Plant Operations Summary, Fiscal Year 1998, cont.

	JULY	AUG	SEPT	OCT	NOV	DEC	JAN	FEB	MAR	APR	MAY	JUNE	MIN	AVG	MAX
EFFLUENT															
NUTRIENTS (mg/L)															
AMMONIA															
AVERAGE	17.53	17.08	19.07	20.80	18.30	15.82	14.00	10.62	9.25	14.86	12.60	11.06		15.08	
MINIMUM	16.60	15.70	17.50	18.70	15.80	9.38	10.80	3.48	5.88	13.80	9.40	5.77	3.48		
MAXIMUM	18.70	18.20	22.00	22.00	22.70	19.00	16.00	16.80	11.70	16.20	15.70	15.20			22.7
NITRITES															
AVERAGE	0.03	0.04	0.06	0.04	0.05	0.22	0.41	0.47	0.47	0.05	0.19	0.40		0.20	
MINIMUM	0.01	0.01	0.05	0.01	0.04	0.04	0.08	0.07	0.10	0.01	0.04	0.06	0.01		
MAXIMUM	0.06	0.06	0.07	0.10	0.06	0.82	0.98	1.15	1.01	0.13	0.47	1.08			1.15
NITRATES															
AVERAGE	0.10	0.03	0.33	0.71	0.07	0.28	0.31	0.53	0.92	1.16	0.29	0.31		0.42	
MINIMUM	0.01	0.01	0.14	0.03	0.02	0.14	0.13	0.46	0.24	0.99	0.14	0.20	0.01		
MAXIMUM	0.35	0.05	0.56	1.01	0.11	0.45	0.59	0.63	1.43	1.49	0.47	0.37			1.49
ORTHOPHOSPHATE															
AVERAGE	2.47	2.38	2.49	2.65	2.16	1.68	1.30	1.09	0.98	0.97	1.21	1.13		1.71	
MINIMUM	2.34	2.19	2.17	2.38	1.64	0.81	1.16	0.48	0.75	0.63	0.91	0.75	0.477		
MAXIMUM	2.57	2.51	2.78	3.00	3.18	2.09	1.44	1.65	1.14	1.25	1.65	1.38			3.18
TKN															
AVERAGE	25.98	25.40	24.55	25.54	24.93	20.94	20.35	16.38	12.43	17.14	16.57	14.27		20.37	
MINIMUM	24.10	24.20	24.00	23.00	20.50	15.50	18.60	9.41	9.10	15.60	13.00	11.60	9.1		
MAXIMUM	27.20	26.70	25.80	30.70	32.40	24.30	22.10	22.30	14.30	20.20	19.60	15.70			32.4
TOTAL PHOSPHORUS															
AVERAGE	4.00	4.72	3.68	3.43	3.15	2.61	2.27	2.01	1.91	1.58	2.00	1.85		2.77	
MINIMUM	3.64	3.48	3.33	2.90	2.33	1.71	2.07	1.17	1.62	1.24	1.83	1.57	1.17		
MAXIMUM	4.41	7.74	4.10	3.85	4.67	2.94	2.56	2.80	2.18	2.06	2.20	2.02			7.74
TPH (IR)															
AVERAGE	2.78	1.93	3.34	2.29	2.11	1.19	1.23	1.16	1.02	1.25	2.15	1.46		1.83	
MINIMUM	2.22	1	2.48	3.56	1	1	1	1	1	1	1.4	1	1		
MAXIMUM	3.49	3.75	4.77	1.56	4.99	1.96	1.69	1.94	1.17	2.25	3	2.5			4.99

Notes:

ND = No Data

Concentration expressed in mg/L unless otherwise noted.

Data are reduced from Deer Island Treatment Plant Monthly Operation Logs. All chemical analyses were conducted by Deer Island Central Laboratory.

Yearly averages in this table are computed from the monthly averages.

The coliform number for a given day is the geometric mean of the three grab samples taken on that day.

Unless otherwise noted, the influent concentrations (avg, min, and max) for the months of April, May and June are North System data.

The exceptions are the following:

* The flow to the Deer Island Treatment Plant reported for the months April through June is the total flow, combined from the North and South Systems.

The % of the total flow that came from the South System = average monthly South System influent divided by average total flow for the month.

** The TSS and BOD influent data for April through June are the flow weighted averages of the contributions from the North and South Systems, as reported in the DITP logs for those months.

Table A-2 Deer Island Influent Characterization, Fiscal Year 1998

Metals (ug/L)															Times
	Jul	Aug	Sep	Oct	Nov	Dec	Jan	Feb	Mar	Apr	May	Jun	Average	Maximum	Detected
ANTIMONY	18.73	20.00	20.00	20.00	20.00	20.00	20.00	20.00	20.00	20.00	20.00	20.00	19.92	20.00	0 of 72
ARSENIC	1.10	1.38	1.29	1.10	1.10	0.77	0.95	0.60	1.14	0.40	1.38	0.99	1.02	2.70	21 of 73
BERYLLIUM	0.50	0.50	0.50	0.50	0.50	0.50	0.50	0.50	0.50	0.50	0.50	0.50	0.50	0.50	0 of 72
BORON	255.57	312.22	254.92	305.78	150.13	188.92	164.79	182.14	125.00	125.00	145.55	192.34	192.82	683.00	34 of 72
CADMIUM	1.00	1.00	1.00	1.00	1.00	1.00	1.00	1.00	1.00	1.00	1.00	1.40	1.02	2.07	1 of 72
CHROMIUM	4.75	6.91	5.41	6.39	4.22	7.75	6.75	4.06	4.55	2.20	9.76	1.50	5.68	24.40	59 of 73
COPPER	90.38	81.67	82.31	75.79	65.59	83.76	74.85	71.72	60.93	63.51	84.57	76.44	75.73	146.00	73 of 73
HEXAVALENT CHROMIUM	5.50	5.50	5.50	8.29	5.50	5.50	5.50	5.50	5.50	5.50	5.50	5.50	5.60	11.00	0 of 35
IRON	1406.32	2097.67	1847.73	1535.01	1247.29	1707.45	1437.39	1328.77	1236.87	1097.65	2642.94	1624.12	1619.59	5020.00	72 of 72
LEAD	12.32	38.35	23.81	17.00	9.81	17.84	12.12	11.10	10.56	8.75	38.64	19.26	18.39	128.00	71 of 72
MERCURY	0.22	0.45	0.31	0.28	0.25	0.31	0.13	0.16	0.20	0.21	0.19	0.24	0.24	0.98	68 of 72
MOLYBDENUM	18.42	20.64	18.36	21.84	10.33	14.32	6.51	8.45	5.42	8.47	11.80	13.56	12.38	39.40	64 of 72
NICKEL	4.93	5.95	4.84	4.00	4.61	5.32	4.00	4.00	4.00	4.00	4.00	4.00	4.45	11.00	8 of 72
SELENIUM	1.10	1.10	1.10	1.10	0.92	0.54	0.45	0.45	0.45	0.90	0.51	0.45	0.71	1.26	1 of 73
SILVER	4.53	3.72	4.63	5.31	2.97	5.86	1.82	2.47	2.52	1.90	4.29	3.22	3.55	10.10	68 of 74
THALLIUM	1.10	1.10	1.10	1.10	0.93	0.62	0.50	0.50	0.50	0.50	0.59	0.50	0.72	1.50	2 of 73
ZINC	105.64	130.78	106.26	104.22	79.13	104.99	81.55	75.78	76.75	73.45	123.82	92.41	95.64	270.00	73 of 73

Cyanide and Phenols (ug/L)															Times
	Jul	Aug	Sep	Oct	Nov	Dec	Jan	Feb	Mar	Apr	May	Jun	Average	Maximum	Detected
CYANIDE	5.00	5.00	5.00	5.00	5.00	5.00	5.00	5.00	5.00	5.00	7.99	5.00	5.40	10.60	1 of 35
TOTAL PHENOLS	34.93	25.29	53.79	54.04	23.29	26.65	8.45	17.65	9.55	6.65	19.24	34.86	23.53	67.20	30 of 33

Oil and Grease, Petroleum Hydrocarbons, and Surfactants (mg/L)															Times
	Jul	Aug	Sep	Oct	Nov	Dec	Jan	Feb	Mar	Apr	May	Jun	Average	Maximum	Detected
PETROLEUM HYDROCARBON	1.46	0.70	2.12	1.05	0.78	0.74	1.11	0.63	0.53	0.50	1.19	0.82	0.95	3.70	35 of 35
TOTAL PETROLEUM HYDROCAF	2.63	3.79	6.29	8.06	4.76	2.47	3.91	1.79	0.50	0.10	6.27	1.18	3.45	13.50	30 of 34
FATS OIL AND GREASE	29.44	33.28	46.52	27.35	29.71	24.45	18.56	21.86	20.42	108.00	15.13	20.02	26.75	108.00	62 of 63
MBAS	5.40	4.62	5.48	5.37	5.14	3.92	3.57	3.85	2.60	3.27	3.20	4.33	4.09	7.00	32 of 32

Table A-2 Deer Island Influent Characterization, Fiscal Year 1998, cont.

Organochlorine Pesticides and PCBs (ug/L)	Organochlorine Pesticides and PCBs (ug/L)												Average	Maximum	Times Detected
	Jul	Aug	Sep	Oct	Nov	Dec	Jan	Feb	Mar	Apr	May	Jun			
4,4'-DDD	0.002	0.002	0.002	0.002	0.002	0.002	0.056	0.002	0.002	0.003	0.002	0.002	0.007	0.206	2 of 37
4,4'-DDE	0.002	0.005	0.002	0.002	0.002	0.002	0.003	0.002	0.002	0.003	0.002	0.002	0.002	0.011	1 of 37
4,4'-DDT	0.002	0.002	0.005	0.002	0.002	0.002	0.225	0.002	0.002	0.003	0.006	0.002	0.024	0.810	5 of 37
ALDRIN	0.002	0.002	0.002	0.002	0.002	0.002	0.003	0.002	0.002	0.003	0.016	0.002	0.004	0.036	1 of 37
ALPHA-BHC	0.002	0.002	0.002	0.002	0.002	0.002	0.003	0.002	0.002	0.003	0.002	0.002	0.002	0.006	0 of 37
ALPHA-CHLORDANE	0.002	0.002	0.002	0.002	0.002	0.002	0.003	0.002	0.002	0.003	0.002	0.002	0.002	0.006	0 of 37
AROCLOR-1016	0.055	0.053	0.055	0.053	0.051	0.052	0.081	0.053	0.052	0.068	0.054	0.052	0.057	0.150	0 of 37
AROCLOR-1221	0.111	0.085	0.110	0.105	0.102	0.103	0.162	0.106	0.103	0.137	0.109	0.103	0.111	0.301	0 of 37
AROCLOR-1232	0.055	0.053	0.055	0.053	0.051	0.052	0.081	0.053	0.052	0.068	0.054	0.052	0.057	0.150	0 of 37
AROCLOR-1242	0.055	0.053	0.055	0.053	0.051	0.052	0.081	0.053	0.052	0.068	0.054	0.052	0.057	0.150	0 of 37
AROCLOR-1248	0.055	0.053	0.055	0.053	0.051	0.052	0.081	0.053	0.052	0.068	0.054	0.052	0.057	0.150	0 of 37
AROCLOR-1254	0.055	0.053	0.055	0.053	0.051	0.052	0.081	0.053	0.052	0.068	0.054	0.052	0.057	0.150	0 of 37
AROCLOR-1260	0.055	0.053	0.055	0.053	0.051	0.052	0.081	0.053	0.052	0.068	0.054	0.052	0.057	0.150	0 of 37
BETA-BHC	0.002	0.002	0.002	0.002	0.002	0.002	0.003	0.002	0.002	0.003	0.002	0.002	0.002	0.006	0 of 37
CHLORDANE (TECHNICAL)	0.055	0.053	0.055	0.053	0.051	0.052	0.081	0.053	0.052	0.068	0.054	0.052	0.057	0.150	0 of 37
DELTA-BHC	0.002	0.002	0.002	0.002	0.002	0.002	0.003	0.002	0.002	0.003	0.002	0.002	0.002	0.006	0 of 37
DIELDRIN	0.002	0.002	0.002	0.002	0.002	0.002	0.003	0.002	0.002	0.003	0.002	0.002	0.002	0.006	0 of 37
ENDOSULFAN I	0.002	0.002	0.002	0.002	0.002	0.002	0.003	0.002	0.002	0.003	0.002	0.002	0.002	0.006	0 of 37
ENDOSULFAN II	0.002	0.002	0.002	0.002	0.002	0.002	0.003	0.002	0.002	0.003	0.002	0.002	0.002	0.006	0 of 37
ENDOSULFAN SULFATE	0.002	0.002	0.002	0.002	0.002	0.002	0.003	0.002	0.002	0.003	0.002	0.002	0.002	0.006	0 of 37
ENDRIN	0.002	0.002	0.002	0.002	0.002	0.002	0.003	0.002	0.002	0.003	0.002	0.002	0.002	0.006	0 of 37
ENDRIN ALDEHYDE	0.002	0.002	0.002	0.002	0.002	0.002	0.003	0.002	0.002	0.003	0.002	0.002	0.002	0.006	0 of 37
ENDRIN KETONE	0.002	0.002	0.002	0.002	0.002	0.002	0.003	0.002	0.002	0.003	0.002	0.002	0.002	0.006	0 of 37
GAMMA-BHC (LINDANE)	0.002	0.002	0.002	0.010	0.005	0.005	0.007	0.002	0.002	0.003	0.002	0.002	0.003	0.017	4 of 37
GAMMA-CHLORDANE	0.002	0.002	0.002	0.002	0.002	0.002	0.003	0.002	0.002	0.003	0.002	0.002	0.002	0.006	0 of 37
HEPTACHLOR	0.002	0.002	0.002	0.002	0.002	0.002	0.003	0.002	0.002	0.003	0.010	0.002	0.003	0.021	1 of 37
HEPTACHLOR EPOXIDE	0.002	0.002	0.002	0.002	0.002	0.002	0.003	0.002	0.002	0.003	0.019	0.002	0.004	0.044	1 of 37
METHOXYCHLOR	0.022	0.021	0.022	0.021	0.020	0.017	0.032	0.021	0.021	0.013	0.021	0.021	0.021	0.060	1 of 37
TOXAPHENE	0.055	0.053	0.055	0.053	0.051	0.052	0.081	0.053	0.052	0.068	0.054	0.052	0.057	0.150	0 of 37

Table A-2 Deer Island Influent Characterization, Fiscal Year 1998, cont.

Semivolatile Organics (ug/L)													Times		
	Jul	Aug	Sep	Oct	Nov	Dec	Jan	Feb	Mar	Apr	May	Jun	Average	Maximum	Detected
1,2,4-TRICHLOROBENZENE	1.06	1.06	1.07	1.05	1.05	1.10	1.10	1.06	1.04	1.10	1.06	1.06	1.07	1.18	0 of 33
1,2-DICHLOROBENZENE	1.06	1.06	1.07	1.05	1.05	1.10	1.10	1.06	1.04	1.10	1.06	1.06	1.07	1.18	0 of 33
1,2-DIPHENYLHYDRAZINE (AS A	1.06	1.06	1.07	1.05	1.05	1.10	1.10	1.06	1.04	1.10	1.06	1.06	1.07	1.18	0 of 33
1,3-DICHLOROBENZENE	1.06	1.06	1.07	1.05	1.05	1.10	1.10	1.06	1.04	1.10	1.06	1.06	1.07	1.18	0 of 33
1,4-DICHLOROBENZENE	1.06	1.06	1.07	1.05	1.05	1.10	1.10	1.06	1.04	1.10	1.06	1.06	1.07	1.18	0 of 33
2,2'-OXYBIS(1-CHLOROPROPANE	1.06	1.06	1.07	1.05	1.05	1.10	1.10	1.06	1.04	1.10	1.06	1.06	1.07	1.18	0 of 33
2,4,5-TRICHLOROPHENOL	1.06	1.06	1.07	1.05	1.05	1.10	1.10	1.06	1.04	1.10	1.06	1.06	1.07	1.18	0 of 33
2,4,6-TRICHLOROPHENOL	1.06	1.06	1.07	1.05	1.05	1.10	1.10	1.06	1.04	1.10	1.06	1.06	1.07	1.18	0 of 33
2,4-DICHLOROPHENOL	1.06	1.06	1.07	1.05	1.05	1.10	1.10	1.06	1.04	1.10	1.06	1.06	1.07	1.18	0 of 33
2,4-DIMETHYLPHENOL	1.06	1.06	1.07	1.05	1.05	1.10	1.10	1.06	1.04	1.10	1.06	1.06	1.07	1.18	0 of 33
2,4-DINITROPHENOL	2.12	2.12	2.15	2.10	2.10	2.19	2.19	2.12	2.07	2.21	2.13	2.11	2.13	2.36	0 of 33
2,4-DINITROTOLUENE	1.06	1.06	1.07	1.05	1.05	1.10	1.10	1.06	1.04	1.10	1.06	1.06	1.07	1.18	0 of 33
2,6-DINITROTOLUENE	1.06	1.06	1.07	1.05	1.05	1.10	1.10	1.06	1.04	1.10	1.06	1.06	1.07	1.18	0 of 33
2-CHLORONAPHTHALENE	1.06	1.06	1.07	1.05	1.05	1.10	1.10	1.06	1.04	1.10	1.06	1.06	1.07	1.18	0 of 33
2-CHLOROPHENOL	1.06	1.06	1.07	1.05	1.05	1.10	1.10	1.06	1.04	1.10	1.06	1.06	1.07	1.18	0 of 33
2-METHYL-4,6-DINITROPHENOL	10.60	10.62	10.74	10.49	10.51	10.95	10.96	10.60	10.36	11.03	10.64	10.55	10.66	11.80	0 of 33
2-METHYLNAPHTHALENE	1.06	1.06	1.07	1.05	1.05	1.10	1.10	1.06	1.04	1.10	1.06	1.06	1.07	1.18	0 of 33
2-METHYLPHENOL	1.06	1.06	1.07	1.05	1.05	2.91	1.10	1.06	1.04	1.10	1.06	1.06	1.20	6.88	1 of 33
2-NITROANILINE	1.06	1.06	1.07	1.05	1.05	1.10	1.10	1.06	1.04	1.10	1.06	1.06	1.07	1.18	0 of 33
2-NITROPHENOL	1.06	1.06	1.07	1.05	1.05	1.10	1.10	1.06	1.04	1.10	1.06	1.06	1.07	1.18	0 of 33
3,3'-DICHLOROBENZIDINE	2.12	2.12	2.15	2.10	2.10	2.19	2.19	2.12	2.07	2.21	2.13	2.11	2.13	2.36	0 of 33
3-NITROANILINE	1.06	1.06	1.07	1.05	1.05	1.10	1.10	1.06	1.04	1.10	1.06	1.06	1.07	1.18	0 of 33
4-BROMOPHENYL PHENYL ETHI	1.06	1.06	1.07	1.05	1.05	1.10	1.10	1.06	1.04	1.10	1.06	1.06	1.07	1.18	0 of 33
4-CHLORO-3-METHYLPHENOL	1.06	1.06	1.07	1.05	1.05	1.10	1.10	1.06	1.04	1.10	1.06	1.06	1.07	1.18	0 of 33
4-CHLOROANILINE	1.06	1.06	1.07	1.05	1.05	1.10	1.10	1.06	1.04	1.10	1.06	1.06	1.07	1.18	0 of 33
4-CHLOROPHENYL PHENYL ET	1.06	1.06	1.07	1.05	1.05	1.10	1.10	1.06	1.04	1.10	1.06	1.06	1.07	1.18	0 of 33
4-METHYLPHENOL (INCLUDES 3-	15.30	14.01	17.38	22.73	14.42	10.73	4.15	1.06	2.59	1.10	4.53	10.80	8.43	26.65	23 of 33
4-NITROANILINE	1.06	1.06	1.07	1.05	1.05	1.10	1.10	1.06	1.04	1.10	1.06	1.06	1.07	1.18	0 of 33
4-NITROPHENOL	2.12	2.12	2.15	2.10	2.10	2.19	2.19	2.12	2.07	2.21	2.13	2.11	2.13	2.36	0 of 33
ACENAPHTHENE	1.06	1.06	1.07	1.05	1.05	1.10	1.10	1.06	1.04	1.10	1.06	1.06	1.07	1.18	0 of 33
ACENAPHTHYLENE	1.06	1.06	1.07	1.05	1.05	1.10	1.10	1.06	1.04	1.10	1.06	1.06	1.07	1.18	0 of 33
ANILINE	1.06	1.06	1.07	1.05	1.05	1.10	1.10	1.06	1.04	1.10	1.06	1.06	1.07	1.18	0 of 33
ANTHRACENE	1.06	1.06	1.07	1.05	1.05	1.10	1.10	1.06	1.04	1.10	1.06	1.06	1.07	1.18	0 of 33
BENZIDINE	5.30	5.31	5.37	5.25	5.26	5.48	5.48	5.30	5.18	5.52	5.32	5.28	5.33	5.90	0 of 33
BENZO(A)ANTHRACENE	1.06	1.06	1.07	1.05	1.05	1.10	1.10	1.06	1.04	1.10	1.06	1.06	1.07	1.18	0 of 33

Table A-2 Deer Island Influent Characterization, Fiscal Year 1998, cont.

Semivolatile Organics (ug/L)													Average	Maximum	Times Detected
	Jul	Aug	Sep	Oct	Nov	Dec	Jan	Feb	Mar	Apr	May	Jun			
BENZO(A)PYRENE	1.06	1.06	1.07	1.05	1.05	1.10	1.10	1.06	1.04	1.10	1.06	1.06	1.07	1.18	0 of 33
BENZO(B)FLUORANTHENE	1.06	1.06	1.07	1.05	1.05	1.10	1.10	1.06	1.04	1.10	1.06	1.06	1.07	1.18	0 of 33
BENZO(GHI)PERYLENE	1.06	1.06	1.07	1.05	1.05	1.10	1.10	1.06	1.04	1.10	1.06	1.06	1.07	1.18	0 of 33
BENZO(K)FLUORANTHENE	1.06	1.06	1.07	1.05	1.05	1.10	1.10	1.06	1.04	1.10	1.06	1.06	1.07	1.18	0 of 33
BENZOIC ACID	21.88	2.12	20.34	15.00	7.29	2.19	7.33	5.57	2.07	2.21	2.13	2.11	6.28	34.40	9 of 33
BENZYL ALCOHOL	4.17	6.75	9.99	11.17	9.42	5.90	5.13	7.81	1.04	6.07	4.75	4.89	5.88	13.80	21 of 33
BIS(2-CHLOROETHOXY)METHANOL	1.06	1.06	1.07	1.05	1.05	1.10	1.10	1.06	1.04	1.10	1.06	1.06	1.07	1.18	0 of 33
BIS(2-CHLOROETHYL)ETHER	1.06	1.06	1.07	1.05	1.05	1.10	1.10	1.06	1.04	1.10	1.06	1.06	1.07	1.18	0 of 33
BIS(2-ETHYLHEXYL)PHTHALATE	7.92	12.35	10.45	7.29	2.83	1.10	3.26	1.06	1.04	1.10	6.04	3.98	4.41	24.90	15 of 33
BUTYL BENZYL PHTHALATE	1.06	1.06	1.07	1.05	1.05	1.10	1.10	1.06	1.04	1.10	1.06	1.06	1.07	1.18	0 of 33
CHRYSENE	1.06	1.06	1.07	1.05	1.05	1.10	1.10	1.06	1.04	1.10	1.06	1.06	1.07	1.18	0 of 33
DIBENZO(A,H)ANTHRACENE	1.06	1.06	1.07	1.05	1.05	1.10	1.10	1.06	1.04	1.10	1.06	1.06	1.07	1.18	0 of 33
DIBENZOFURAN	1.06	1.06	1.07	1.05	1.05	1.10	1.10	1.06	1.04	1.10	1.06	1.06	1.07	1.18	0 of 33
DIETHYL PHTHALATE	2.54	1.06	1.07	3.85	2.49	1.10	3.58	1.06	1.04	1.10	1.06	1.06	1.63	6.81	5 of 33
DIMETHYL PHTHALATE	1.06	1.06	1.07	1.05	1.05	1.10	1.10	1.06	1.04	1.10	1.06	1.06	1.07	1.18	0 of 33
DI-N-BUTYLPHTHALATE	1.06	1.06	1.07	1.05	1.05	1.10	1.10	1.06	1.04	1.10	1.06	1.06	1.07	1.18	0 of 33
DI-N-OCTYLPHTHALATE	1.06	1.06	1.07	1.05	1.05	1.10	1.10	1.06	1.04	1.10	1.06	1.06	1.07	1.18	0 of 33
FLUORANTHENE	1.06	1.06	1.07	1.05	1.05	1.10	1.10	1.06	1.04	1.10	1.06	1.06	1.07	1.18	0 of 33
FLUORENE	1.06	1.06	1.07	1.05	1.05	1.10	1.10	1.06	1.04	1.10	1.06	1.06	1.07	1.18	0 of 33
HEXACHLOROENZENE	1.06	1.06	1.07	1.05	1.05	1.10	1.10	1.06	1.04	1.10	1.06	1.06	1.07	1.18	0 of 33
HEXACHLOROBUTADIENE	1.06	1.06	1.07	1.05	1.05	1.10	1.10	1.06	1.04	1.10	1.06	1.06	1.07	1.18	0 of 33
HEXACHLOROCYCLOPENTADIENE	5.30	5.31	5.37	5.25	5.26	5.48	5.48	5.30	5.18	5.52	5.32	5.28	5.33	5.90	0 of 33
HEXACHLOROETHANE	1.06	1.06	1.07	1.05	1.05	1.10	1.10	1.06	1.04	1.10	1.06	1.06	1.07	1.18	0 of 33
INDENO(1,2,3-CD)PYRENE	1.06	1.06	1.07	1.05	1.05	1.10	1.10	1.06	1.04	1.10	1.06	1.06	1.07	1.18	0 of 33
ISOPHORONE	1.06	1.06	1.07	1.05	1.05	1.10	1.10	1.06	1.04	1.10	1.06	1.06	1.07	1.18	0 of 33
NAPHTHALENE	1.06	1.06	1.07	1.05	1.05	1.10	1.10	1.06	1.04	1.10	1.06	1.06	1.07	1.18	0 of 33
NITROBENZENE	1.06	1.06	1.07	1.05	1.05	1.10	1.10	1.06	1.04	1.10	1.06	1.06	1.07	1.18	0 of 33
N-NITROSODIMETHYLAMINE	1.06	1.06	1.07	1.05	1.05	1.10	1.10	1.06	1.04	1.10	1.06	1.06	1.07	1.18	0 of 33
N-NITROSODI-N-PROPYLAMINE	1.06	1.06	1.07	1.05	1.05	1.11	1.10	1.06	1.04	1.10	1.06	1.06	1.07	1.18	0 of 32
N-NITROSODIPHENYLAMINE	1.06	1.06	1.07	1.05	1.05	1.10	1.10	1.06	1.04	1.10	1.06	1.06	1.07	1.18	0 of 33
PENTACHLOROPHENOL	5.30	5.31	5.37	5.25	5.26	5.48	5.48	5.30	5.18	5.52	5.32	5.28	5.33	5.90	0 of 33
PHENANTHRENE	1.06	1.06	1.07	1.05	1.05	1.74	1.35	0.87	0.10	0.11	0.57	0.11	0.78	3.04	5 of 33
PHENOL	2.12	2.12	2.15	3.74	2.10	2.19	2.19	2.12	2.07	2.21	2.13	2.11	2.20	5.54	1 of 33
PYRENE	1.06	1.06	1.07	1.05	1.05	1.10	1.10	1.06	1.04	1.10	1.06	1.06	1.07	1.18	0 of 33

Table A-2 Deer Island Influent Characterization, Fiscal Year 1998, cont.

Volatile Organics (ug/L)													Times			
	Jul	Aug	Sep	Oct	Nov	Dec	Jan	Feb	Mar	Apr	May	Jun	Average	Maximum	Detected	
1,1,1-TRICHLOROETHANE	0.50	0.50	0.50	0.50	0.50	0.50	0.50	0.50	0.50	0.50	0.50	0.50	0.50	0.50	0.50	0 of 39
1,1,2,2-TETRACHLOROETHANE	0.50	0.50	0.50	0.50	0.50	0.50	0.50	0.50	0.50	0.50	0.50	0.50	0.50	0.50	0.50	0 of 39
1,1,2-TRICHLOROETHANE	0.50	0.50	0.50	0.50	0.50	0.50	0.50	0.50	0.50	0.50	0.50	0.50	0.50	0.50	0.50	0 of 39
1,1-DICHLOROETHANE	0.50	0.50	0.50	0.50	0.50	0.50	0.50	0.50	0.50	0.50	0.50	0.50	0.50	0.50	0.50	0 of 39
1,1-DICHLOROETHENE	0.50	0.50	0.50	0.50	0.50	0.50	0.50	0.50	0.50	0.50	0.50	0.50	0.50	0.50	0.50	0 of 39
1,2-DICHLOROBENZENE	0.50	0.50	0.50	0.50	0.50	0.50	0.50	0.50	0.50	0.50	0.50	0.50	0.50	0.50	0.50	0 of 39
1,2-DICHLOROETHANE	0.50	0.50	0.50	0.50	0.50	0.50	0.50	0.50	0.50	0.50	0.50	0.50	0.50	0.50	0.50	0 of 39
1,2-DICHLOROPROPANE	0.50	0.50	0.50	2.71	0.50	0.50	0.50	0.50	0.50	0.50	0.50	0.50	0.50	0.57	5.00	1 of 39
1,3-DICHLOROBENZENE	0.50	0.50	0.99	0.50	0.50	0.50	0.50	0.50	0.50	0.50	0.50	0.50	0.50	0.53	1.93	1 of 39
1,4-DICHLOROBENZENE	2.15	2.27	2.07	0.50	0.50	0.50	0.50	0.50	0.50	0.50	0.50	0.50	0.91	2.83	13 of 39	
2-BUTANONE	1.45	0.50	13.96	0.50	0.50	1.62	0.50	0.50	1.81	0.50	0.50	3.23	1.79	36.70	7 of 39	
2-CHLOROETHYL VINYL ETHER	0.50	0.50	0.50	0.50	0.50	0.50	0.50	0.50	0.50	0.50	0.50	0.50	0.50	0.50	0.50	0 of 39
2-HEXANONE	0.50	0.50	0.50	0.50	0.50	0.50	0.50	0.50	0.50	0.50	0.50	0.50	0.50	0.50	0.50	0 of 39
4-METHYL-2-PENTANONE	0.50	0.50	0.50	0.50	0.50	1.28	0.50	0.50	0.50	0.50	0.50	0.50	0.55	2.85	1 of 39	
ACETONE	168.21	174.07	139.55	122.49	96.12	188.86	94.65	97.04	115.92	147.97	175.09	143.53	139.07	351.00	39 of 39	
ACROLEIN	0.50	0.50	0.50	0.50	0.50	0.50	0.50	0.50	0.50	0.50	0.50	0.50	0.50	0.50	0.50	0 of 39
ACRYLONITRILE	0.50	0.50	0.50	0.50	0.50	0.50	0.50	0.50	0.50	0.50	0.50	0.50	0.50	0.50	0.50	0 of 39
BENZENE	1.30	1.34	0.76	0.50	0.50	0.50	0.50	0.50	0.50	0.50	0.50	0.50	0.67	3.22	7 of 39	
BROMODICHLOROMETHANE	1.22	0.50	0.50	0.50	0.50	0.50	0.50	0.50	0.50	0.50	0.50	0.50	0.58	5.00	1 of 39	
BROMOFORM	0.50	0.50	0.50	0.50	0.50	0.50	0.50	0.50	0.50	0.50	0.50	0.50	0.50	0.50	0.50	0 of 39
BROMOMETHANE	0.50	0.50	0.50	0.50	0.50	0.50	0.50	0.50	0.50	0.50	0.50	0.50	0.50	0.50	0.50	0 of 39
CARBON DISULFIDE	19.33	1.75	2.86	3.23	2.84	3.47	1.81	0.50	0.50	0.50	0.50	0.50	3.48	96.00	18 of 39	
CARBON TETRACHLORIDE	0.50	0.50	0.50	0.50	0.50	0.50	0.50	0.50	0.50	0.50	0.50	0.50	0.50	0.50	0.50	0 of 39
CHLOROBENZENE	0.50	0.50	0.50	0.50	0.50	0.50	0.50	0.50	0.50	0.50	0.50	0.50	0.50	0.50	0.50	0 of 39
CHLOROETHANE	0.50	0.50	0.50	0.50	0.50	0.50	0.50	0.50	0.50	0.50	0.50	0.50	0.50	0.50	0.50	0 of 39
CHLOROFORM	5.66	4.70	3.75	5.91	6.95	6.15	4.10	4.62	5.53	7.71	7.98	8.83	6.12	14.40	39 of 39	
CHLOROMETHANE	0.50	0.50	0.50	0.50	0.50	0.50	0.50	0.50	0.50	0.50	0.50	0.50	0.50	0.50	0.50	0 of 39
CIS-1,2-DICHLOROETHENE	2.48	2.04	2.34	1.79	2.35	3.45	0.98	1.15	1.14	0.50	0.50	0.50	2.02	1.66	4.39	26 of 39
CIS-1,3-DICHLOROPROPENE	0.50	0.50	0.50	0.50	0.50	0.50	0.50	0.50	0.50	0.50	0.50	0.50	0.50	0.50	0.50	0 of 39
DIBROMOCHLOROMETHANE	0.50	0.50	0.50	0.50	0.50	0.50	0.50	0.50	0.50	0.50	0.50	0.50	0.50	0.50	0.50	0 of 39
ETHYLBENZENE	2.56	1.82	1.29	0.50	1.14	0.50	0.50	0.50	0.50	0.50	0.50	0.50	0.94	6.51	8 of 39	
M,P-XYLENE	9.12	6.70	5.24	2.19	1.61	5.70	0.50	1.19	0.50	0.50	1.89	0.50	2.94	24.60	21 of 39	
METHYLENE CHLORIDE	3.85	3.64	6.58	3.71	2.38	3.55	1.54	3.49	2.27	3.67	3.52	1.51	3.12	13.70	27 of 39	
O-XYLENE	3.40	3.12	2.51	0.50	0.50	1.80	0.50	0.50	0.50	0.50	0.50	0.50	1.22	11.50	10 of 39	

Table A-2 Deer Island Influent Characterization, Fiscal Year 1998, cont.

Volatile Organics (ug/L)	Jul	Aug	Sep	Oct	Nov	Dec	Jan	Feb	Mar	Apr	May	Jun	Average	Maximum	Times Detected
STYRENE	0.50	0.50	0.50	0.50	0.50	0.50	0.50	0.50	0.50	0.50	3.32	0.50	0.86	6.56	1 of 39
TETRACHLOROETHENE	3.28	3.93	6.09	2.25	6.89	3.08	7.08	5.54	3.99	6.15	1.87	3.28	4.42	12.90	34 of 39
TOLUENE	12.52	13.45	12.60	6.70	4.88	7.96	3.67	3.14	3.22	3.29	4.32	4.49	6.46	37.50	39 of 39
TRANS-1,2-DICHLOROETHENE	0.50	0.50	0.50	0.50	0.50	0.50	0.50	0.50	0.50	0.50	0.50	0.50	0.50	0.50	0 of 39
TRANS-1,3-DICHLOROPROPENE	0.50	0.50	0.50	0.50	0.50	0.50	0.50	0.50	0.50	0.50	0.50	0.50	0.50	0.50	0 of 39
TRICHLOROETHENE	3.13	2.47	3.07	2.23	3.88	3.75	2.56	2.46	2.48	1.59	0.50	0.91	2.34	5.86	29 of 39
TRICHLOROFLUOROMETHANE	0.50	0.50	0.50	0.50	0.50	0.50	0.50	0.50	0.50	0.50	0.50	0.50	0.50	0.50	0 of 39
VINYL ACETATE	0.50	0.50	0.50	0.50	0.50	0.50	0.50	0.50	0.50	0.50	0.50	0.50	0.50	0.50	0 of 39
VINYL CHLORIDE	0.50	0.50	0.50	0.50	0.50	0.50	0.50	0.50	0.50	0.50	0.50	0.50	0.50	0.50	0 of 39

Notes:

Results in **bold italics** indicate one or more detects in the month.

Yearly averages are calculated from individual results collected in the fiscal year.

Non-detected compounds are assumed to equal one half of the detection limit for metals and inorganics and one tenth of the reporting limit for organic compounds.

All May samples were collected at the grit facility influent site because the official influent site was not available.

Table A-3 Deer Island Influent Loadings, Fiscal Year 1998

Metals (lbs/day)														Times	
	Jul	Aug	Sep	Oct	Nov	Dec	Jan	Feb	Mar	Apr	May	Jun	Average	Maximum	Detected
ANTIMONY	28.82	32.47	30.94	31.02	39.15	39.01	48.37	46.74	52.79	51.58	80.56	53.67	42.39	117.95	0 of 72
ARSENIC	1.69	2.24	2.00	1.71	2.15	1.51	2.30	1.39	3.00	1.03	5.57	2.66	2.18	14.24	21 of 73
BERYLLIUM	0.77	0.81	0.77	0.78	0.98	0.98	1.21	1.17	1.32	1.29	2.01	1.34	1.06	2.95	0 of 72
BORON	393.25	506.92	394.36	474.20	293.84	368.50	398.56	425.68	329.95	322.40	586.24	516.10	410.26	1021.97	34 of 72
CADMIUM	1.54	1.62	1.55	1.55	1.96	1.95	2.42	2.34	2.64	2.58	4.03	3.75	2.17	6.17	1 of 72
CHROMIUM	7.31	11.21	8.36	9.91	8.26	15.13	16.32	9.50	12.00	5.66	39.33	4.02	12.09	65.42	59 of 73
COPPER	139.06	132.60	127.33	117.54	128.38	163.39	181.03	167.61	160.83	163.82	340.62	205.09	161.12	451.99	73 of 73
HEXAVALENT CHROMIUM	8.87	8.48	8.35	11.67	11.22	9.84	15.71	12.22	14.66	14.39	29.23	14.95	12.67	31.25	0 of 35
IRON	2163.92	3405.80	2858.35	2380.50	2441.31	3330.52	3476.57	3105.49	3264.82	2831.08	10645.19	4357.90	3445.91	16100.26	72 of 72
LEAD	18.96	62.27	36.84	26.36	19.21	34.81	29.31	25.93	27.88	22.56	155.62	51.67	39.12	331.46	71 of 72
MERCURY	0.34	0.73	0.48	0.43	0.49	0.60	0.32	0.37	0.52	0.54	0.76	0.64	0.50	2.18	68 of 72
MOLYBDENUM	28.34	33.51	28.40	33.87	20.22	27.92	15.73	19.76	14.29	21.84	47.52	36.38	26.34	86.67	64 of 72
NICKEL	7.59	9.66	7.48	6.20	9.01	10.37	9.67	9.35	10.56	10.32	16.11	10.73	9.48	23.86	8 of 72
SELENIUM	1.69	1.79	1.70	1.71	1.80	1.06	1.09	1.05	1.19	2.32	2.05	1.21	1.50	2.65	1 of 73
SILVER	6.97	6.04	7.17	8.24	5.81	11.44	4.41	5.76	6.64	4.91	17.28	8.64	7.56	29.25	68 of 74
THALLIUM	1.69	1.79	1.70	1.71	1.83	1.21	1.21	1.17	1.32	1.29	2.38	1.34	1.54	2.95	2 of 73
ZINC	162.55	212.33	164.38	161.63	154.88	204.79	197.25	177.10	202.58	189.45	498.73	247.96	203.49	713.66	73 of 73

Cyanide and Phenols (lbs/day)														Times	
	Jul	Aug	Sep	Oct	Nov	Dec	Jan	Feb	Mar	Apr	May	Jun	Average	Maximum	Detected
CYANIDE	8.06	7.71	7.59	7.04	10.20	8.94	14.28	11.11	13.32	13.08	42.48	13.59	12.23	60.22	1 of 35
TOTAL PHENOLS	53.97	40.49	83.57	78.80	44.18	46.93	20.75	40.71	26.76	16.89	94.87	93.53	52.54	121.32	30 of 33

Oil and Grease, Petroleum Hydrocarbons, and Surfactants (lbs/day)														Times	
	Jul	Aug	Sep	Oct	Nov	Dec	Jan	Feb	Mar	Apr	May	Jun	Average	Maximum	Detected
PETROLEUM HYDROCARBON	2356	1074	3213	1477	1594	1331	3169	1394	1402	1296	6304	2225	2154	6926	35 of 35
TOTAL PETROLEUM HYDROCARBON	4240	5849	9557	11340	9718	4419	11171	3976	1342	258	33315	3213	7764	40906	30 of 34
FATS OIL AND GREASE	46505	56585	70782	42697	60601	47946	50326	50253	62945	278585	80401	58840	59416	278585	62 of 63
MBAS	8339	7389	8508	7824	9744	6901	8773	8878	7282	8326	12687	11631	8666	14259	32 of 32

Table A-3 Deer Island Influent Loadings, Fiscal Year 1998, cont.

Organochlorine Pesticides and PCBs (lbs/day)														Times	
	Jul	Aug	Sep	Oct	Nov	Dec	Jan	Feb	Mar	Apr	May	Jun	Average	Maximum	Detected
4,4'-DDD	0.003	0.003	0.003	0.003	0.004	0.004	0.138	0.005	0.006	0.007	0.010	0.006	0.016	0.400	2 of 37
4,4'-DDE	0.003	0.008	0.003	0.003	0.004	0.004	0.008	0.005	0.006	0.007	0.010	0.006	0.005	0.021	1 of 37
4,4'-DDT	0.003	0.003	0.007	0.003	0.004	0.004	0.553	0.005	0.006	0.007	0.030	0.006	0.052	1.573	5 of 37
ALDRIN	0.003	0.003	0.003	0.003	0.004	0.004	0.008	0.005	0.006	0.007	0.077	0.006	0.009	0.142	1 of 37
ALPHA-BHC	0.003	0.003	0.003	0.003	0.004	0.004	0.008	0.005	0.006	0.007	0.010	0.006	0.005	0.012	0 of 37
ALPHA-CHLORDANE	0.003	0.003	0.003	0.003	0.004	0.004	0.008	0.005	0.006	0.007	0.010	0.006	0.005	0.012	0 of 37
AROCLOR-1016	0.083	0.085	0.085	0.077	0.097	0.091	0.199	0.122	0.145	0.174	0.268	0.138	0.123	0.328	0 of 37
AROCLOR-1221	0.166	0.135	0.170	0.154	0.194	0.182	0.398	0.244	0.289	0.348	0.535	0.277	0.242	0.655	0 of 37
AROCLOR-1232	0.083	0.085	0.085	0.077	0.097	0.091	0.199	0.122	0.145	0.174	0.268	0.138	0.123	0.328	0 of 37
AROCLOR-1242	0.083	0.085	0.085	0.077	0.097	0.091	0.199	0.122	0.145	0.174	0.268	0.138	0.123	0.328	0 of 37
AROCLOR-1248	0.083	0.085	0.085	0.077	0.097	0.091	0.199	0.122	0.145	0.174	0.268	0.138	0.123	0.328	0 of 37
AROCLOR-1254	0.083	0.085	0.085	0.077	0.097	0.091	0.199	0.122	0.145	0.174	0.268	0.138	0.123	0.328	0 of 37
AROCLOR-1260	0.083	0.085	0.085	0.077	0.097	0.091	0.199	0.122	0.145	0.174	0.268	0.138	0.123	0.328	0 of 37
BETA-BHC	0.003	0.003	0.003	0.003	0.004	0.004	0.008	0.005	0.006	0.007	0.010	0.006	0.005	0.012	0 of 37
CHLORDANE (TECHNICAL)	0.083	0.085	0.085	0.077	0.097	0.091	0.199	0.122	0.145	0.174	0.268	0.138	0.123	0.328	0 of 37
DELTA-BHC	0.003	0.003	0.003	0.003	0.004	0.004	0.008	0.005	0.006	0.007	0.010	0.006	0.005	0.012	0 of 37
DIELDRIN	0.003	0.003	0.003	0.003	0.004	0.004	0.008	0.005	0.006	0.007	0.010	0.006	0.005	0.012	0 of 37
ENDOSULFAN I	0.003	0.003	0.003	0.003	0.004	0.004	0.008	0.005	0.006	0.007	0.010	0.006	0.005	0.012	0 of 37
ENDOSULFAN II	0.003	0.003	0.003	0.003	0.004	0.004	0.008	0.005	0.006	0.007	0.010	0.006	0.005	0.012	0 of 37
ENDOSULFAN SULFATE	0.003	0.003	0.003	0.003	0.004	0.004	0.008	0.005	0.006	0.007	0.010	0.006	0.005	0.012	0 of 37
ENDRIN	0.003	0.003	0.003	0.003	0.004	0.004	0.008	0.005	0.006	0.007	0.010	0.006	0.005	0.012	0 of 37
ENDRIN ALDEHYDE	0.003	0.003	0.003	0.003	0.004	0.004	0.008	0.005	0.006	0.007	0.010	0.006	0.005	0.012	0 of 37
ENDRIN KETONE	0.003	0.003	0.003	0.003	0.004	0.004	0.008	0.005	0.006	0.007	0.010	0.006	0.005	0.012	0 of 37
GAMMA-BHC (LINDANE)	0.003	0.003	0.003	0.014	0.009	0.008	0.017	0.005	0.006	0.007	0.010	0.006	0.007	0.031	4 of 37
GAMMA-CHLORDANE	0.003	0.003	0.003	0.003	0.004	0.004	0.008	0.005	0.006	0.007	0.010	0.006	0.005	0.012	0 of 37
HEPTACHLOR	0.003	0.003	0.003	0.003	0.004	0.004	0.008	0.005	0.006	0.007	0.048	0.006	0.007	0.084	1 of 37
HEPTACHLOR EPOXIDE	0.003	0.003	0.003	0.003	0.004	0.004	0.008	0.005	0.006	0.007	0.094	0.006	0.010	0.175	1 of 37
METHOXYCHLOR	0.033	0.034	0.034	0.031	0.039	0.030	0.080	0.049	0.058	0.034	0.104	0.055	0.046	0.124	1 of 37
TOXAPHENE	0.083	0.085	0.085	0.077	0.097	0.091	0.199	0.122	0.145	0.174	0.268	0.138	0.123	0.328	0 of 37

Table A-3 Deer Island Influent Loadings, Fiscal Year 1998, cont.

Semivolatile Organics (lbs/day)	Jul	Aug	Sep	Oct	Nov	Dec	Jan	Feb	Mar	Apr	May	Jun	Average	Maximum	Times Detected
1,2,4-TRICHLOROBENZENE	1.64	1.70	1.67	1.53	1.99	1.93	2.69	2.44	2.90	2.80	5.25	2.83	2.38	6.37	0 of 33
1,2-DICHLOROBENZENE	1.64	1.70	1.67	1.53	1.99	1.93	2.69	2.44	2.90	2.80	5.25	2.83	2.38	6.37	0 of 33
1,2-DIPHENYLHYDRAZINE (AS AZOB)	1.64	1.70	1.67	1.53	1.99	1.93	2.69	2.44	2.90	2.80	5.25	2.83	2.38	6.37	0 of 33
1,3-DICHLOROBENZENE	1.64	1.70	1.67	1.53	1.99	1.93	2.69	2.44	2.90	2.80	5.25	2.83	2.38	6.37	0 of 33
1,4-DICHLOROBENZENE	1.64	1.70	1.67	1.53	1.99	1.93	2.69	2.44	2.90	2.80	5.25	2.83	2.38	6.37	0 of 33
2,2'-OXYBIS(1-CHLOROPROPANE)	1.64	1.70	1.67	1.53	1.99	1.93	2.69	2.44	2.90	2.80	5.25	2.83	2.38	6.37	0 of 33
2,4,5-TRICHLOROPHENOL	1.64	1.70	1.67	1.53	1.99	1.93	2.69	2.44	2.90	2.80	5.25	2.83	2.38	6.37	0 of 33
2,4,6-TRICHLOROPHENOL	1.64	1.70	1.67	1.53	1.99	1.93	2.69	2.44	2.90	2.80	5.25	2.83	2.38	6.37	0 of 33
2,4-DICHLOROPHENOL	1.64	1.70	1.67	1.53	1.99	1.93	2.69	2.44	2.90	2.80	5.25	2.83	2.38	6.37	0 of 33
2,4-DIMETHYLPHENOL	1.64	1.70	1.67	1.53	1.99	1.93	2.69	2.44	2.90	2.80	5.25	2.83	2.38	6.37	0 of 33
2,4-DINITROPHENOL	3.28	3.40	3.34	3.06	3.99	3.86	5.38	4.89	5.81	5.61	10.49	5.66	4.76	12.74	0 of 33
2,4-DINITROTOLUENE	1.64	1.70	1.67	1.53	1.99	1.93	2.69	2.44	2.90	2.80	5.25	2.83	2.38	6.37	0 of 33
2,6-DINITROTOLUENE	1.64	1.70	1.67	1.53	1.99	1.93	2.69	2.44	2.90	2.80	5.25	2.83	2.38	6.37	0 of 33
2-CHLORONAPHTHALENE	1.64	1.70	1.67	1.53	1.99	1.93	2.69	2.44	2.90	2.80	5.25	2.83	2.38	6.37	0 of 33
2-CHLOROPHENOL	1.64	1.70	1.67	1.53	1.99	1.93	2.69	2.44	2.90	2.80	5.25	2.83	2.38	6.37	0 of 33
2-METHYL-4,6-DINITROPHENOL	16.38	17.01	16.68	15.30	19.94	19.28	26.91	24.45	29.03	28.04	52.46	28.31	23.80	63.69	0 of 33
2-METHYLNAPHTHALENE	1.64	1.70	1.67	1.53	1.99	1.93	2.69	2.44	2.90	2.80	5.25	2.83	2.38	6.37	0 of 33
2-METHYLPHENOL	1.64	1.70	1.67	1.53	1.99	5.12	2.69	2.44	2.90	2.80	5.25	2.83	2.67	11.48	1 of 33
2-NITROANILINE	1.64	1.70	1.67	1.53	1.99	1.93	2.69	2.44	2.90	2.80	5.25	2.83	2.38	6.37	0 of 33
2-NITROPHENOL	1.64	1.70	1.67	1.53	1.99	1.93	2.69	2.44	2.90	2.80	5.25	2.83	2.38	6.37	0 of 33
3,3'-DICHLOROBENZIDINE	3.28	3.40	3.34	3.06	3.99	3.86	5.38	4.89	5.81	5.61	10.49	5.66	4.76	12.74	0 of 33
3-NITROANILINE	1.64	1.70	1.67	1.53	1.99	1.93	2.69	2.44	2.90	2.80	5.25	2.83	2.38	6.37	0 of 33
4-BROMOPHENYL PHENYL ETHER	1.64	1.70	1.67	1.53	1.99	1.93	2.69	2.44	2.90	2.80	5.25	2.83	2.38	6.37	0 of 33
4-CHLORO-3-METHYLPHENOL	1.64	1.70	1.67	1.53	1.99	1.93	2.69	2.44	2.90	2.80	5.25	2.83	2.38	6.37	0 of 33
4-CHLOROANILINE	1.64	1.70	1.67	1.53	1.99	1.93	2.69	2.44	2.90	2.80	5.25	2.83	2.38	6.37	0 of 33
4-CHLOROPHENYL PHENYL ETHER	1.64	1.70	1.67	1.53	1.99	1.93	2.69	2.44	2.90	2.80	5.25	2.83	2.38	6.37	0 of 33
4-METHYLPHENOL (INCLUDES 3-MET)	23.65	22.43	27.00	33.15	27.35	18.89	10.19	2.44	7.26	2.80	22.32	28.99	18.82	66.05	23 of 33
4-NITROANILINE	1.64	1.70	1.67	1.53	1.99	1.93	2.69	2.44	2.90	2.80	5.25	2.83	2.38	6.37	0 of 33
4-NITROPHENOL	3.28	3.40	3.34	3.06	3.99	3.86	5.38	4.89	5.81	5.61	10.49	5.66	4.76	12.74	0 of 33
ACENAPHTHENE	1.64	1.70	1.67	1.53	1.99	1.93	2.69	2.44	2.90	2.80	5.25	2.83	2.38	6.37	0 of 33
ACENAPHTHYLENE	1.64	1.70	1.67	1.53	1.99	1.93	2.69	2.44	2.90	2.80	5.25	2.83	2.38	6.37	0 of 33
ANILINE	1.64	1.70	1.67	1.53	1.99	1.93	2.69	2.44	2.90	2.80	5.25	2.83	2.38	6.37	0 of 33
ANTHRACENE	1.64	1.70	1.67	1.53	1.99	1.93	2.69	2.44	2.90	2.80	5.25	2.83	2.38	6.37	0 of 33
BENZIDINE	8.19	8.50	8.34	7.65	9.97	9.64	13.45	12.22	14.51	14.02	26.23	14.15	11.90	31.85	0 of 33
BENZO(A)ANTHRACENE	1.64	1.70	1.67	1.53	1.99	1.93	2.69	2.44	2.90	2.80	5.25	2.83	2.38	6.37	0 of 33

Table A-3 Deer Island Influent Loadings, Fiscal Year 1998, cont.

Semivolatile Organics (lbs/day)	Jul	Aug	Sep	Oct	Nov	Dec	Jan	Feb	Mar	Apr	May	Jun	Average	Maximum	Times Detected
BENZO(A)PYRENE	1.64	1.70	1.67	1.53	1.99	1.93	2.69	2.44	2.90	2.80	5.25	2.83	2.38	6.37	0 of 33
BENZO(B)FLUORANTHENE	1.64	1.70	1.67	1.53	1.99	1.93	2.69	2.44	2.90	2.80	5.25	2.83	2.38	6.37	0 of 33
BENZO(GHI)PERYLENE	1.64	1.70	1.67	1.53	1.99	1.93	2.69	2.44	2.90	2.80	5.25	2.83	2.38	6.37	0 of 33
BENZO(K)FLUORANTHENE	1.64	1.70	1.67	1.53	1.99	1.93	2.69	2.44	2.90	2.80	5.25	2.83	2.38	6.37	0 of 33
BENZOIC ACID	33.81	3.40	31.60	21.87	13.83	3.86	18.00	12.83	5.81	5.61	10.49	5.66	14.01	45.90	9 of 33
BENZYL ALCOHOL	6.44	10.80	15.52	16.29	17.87	10.39	12.59	18.02	2.90	15.42	23.44	13.12	13.13	40.52	21 of 33
BIS(2-CHLOROETHOXY)METHANE	1.64	1.70	1.67	1.53	1.99	1.93	2.69	2.44	2.90	2.80	5.25	2.83	2.38	6.37	0 of 33
BIS(2-CHLOROETHYL)ETHER	1.64	1.70	1.67	1.53	1.99	1.93	2.69	2.44	2.90	2.80	5.25	2.83	2.38	6.37	0 of 33
BIS(2-ETHYLHEXYL)PHTHALATE	12.24	19.77	16.23	10.64	5.38	1.93	8.00	2.44	2.90	2.80	29.78	10.68	9.85	46.36	15 of 33
BUTYL BENZYL PHTHALATE	1.64	1.70	1.67	1.53	1.99	1.93	2.69	2.44	2.90	2.80	5.25	2.83	2.38	6.37	0 of 33
CHRYSENE	1.64	1.70	1.67	1.53	1.99	1.93	2.69	2.44	2.90	2.80	5.25	2.83	2.38	6.37	0 of 33
DIBENZO(A,H)ANTHRACENE	1.64	1.70	1.67	1.53	1.99	1.93	2.69	2.44	2.90	2.80	5.25	2.83	2.38	6.37	0 of 33
DIBENZOFURAN	1.64	1.70	1.67	1.53	1.99	1.93	2.69	2.44	2.90	2.80	5.25	2.83	2.38	6.37	0 of 33
DIETHYL PHTHALATE	3.93	1.70	1.67	5.62	4.72	1.93	8.78	2.44	2.90	2.80	5.25	2.83	3.64	12.28	5 of 33
DIMETHYL PHTHALATE	1.64	1.70	1.67	1.53	1.99	1.93	2.69	2.44	2.90	2.80	5.25	2.83	2.38	6.37	0 of 33
DI-N-BUTYLPHTHALATE	1.64	1.70	1.67	1.53	1.99	1.93	2.69	2.44	2.90	2.80	5.25	2.83	2.38	6.37	0 of 33
DI-N-OCTYLPHTHALATE	1.64	1.70	1.67	1.53	1.99	1.93	2.69	2.44	2.90	2.80	5.25	2.83	2.38	6.37	0 of 33
FLUORANTHENE	1.64	1.70	1.67	1.53	1.99	1.93	2.69	2.44	2.90	2.80	5.25	2.83	2.38	6.37	0 of 33
FLUORENE	1.64	1.70	1.67	1.53	1.99	1.93	2.69	2.44	2.90	2.80	5.25	2.83	2.38	6.37	0 of 33
HEXACHLOROBENZENE	1.64	1.70	1.67	1.53	1.99	1.93	2.69	2.44	2.90	2.80	5.25	2.83	2.38	6.37	0 of 33
HEXACHLOROBUTADIENE	1.64	1.70	1.67	1.53	1.99	1.93	2.69	2.44	2.90	2.80	5.25	2.83	2.38	6.37	0 of 33
HEXACHLOROCYCLOPENTADIENE	8.19	8.50	8.34	7.65	9.97	9.64	13.45	12.22	14.51	14.02	26.23	14.15	11.90	31.85	0 of 33
HEXACHLOROETHANE	1.64	1.70	1.67	1.53	1.99	1.93	2.69	2.44	2.90	2.80	5.25	2.83	2.38	6.37	0 of 33
INDENO(1,2,3-CD)PYRENE	1.64	1.70	1.67	1.53	1.99	1.93	2.69	2.44	2.90	2.80	5.25	2.83	2.38	6.37	0 of 33
ISOPHORONE	1.64	1.70	1.67	1.53	1.99	1.93	2.69	2.44	2.90	2.80	5.25	2.83	2.38	6.37	0 of 33
NAPHTHALENE	1.64	1.70	1.67	1.53	1.99	1.93	2.69	2.44	2.90	2.80	5.25	2.83	2.38	6.37	0 of 33
NITROBENZENE	1.64	1.70	1.67	1.53	1.99	1.93	2.69	2.44	2.90	2.80	5.25	2.83	2.38	6.37	0 of 33
N-NITROSODIMETHYLAMINE	1.64	1.70	1.67	1.53	1.99	1.93	2.69	2.44	2.90	2.80	5.25	2.83	2.38	6.37	0 of 33
N-NITROSODI-N-PROPYLAMINE	1.64	1.70	1.67	1.53	1.99	1.91	2.69	2.44	2.90	2.80	5.25	2.83	2.39	6.37	0 of 32
N-NITROSODIPHENYLAMINE	1.64	1.70	1.67	1.53	1.99	1.93	2.69	2.44	2.90	2.80	5.25	2.83	2.38	6.37	0 of 33
PENTACHLOROPHENOL	8.19	8.50	8.34	7.65	9.97	9.64	13.45	12.22	14.51	14.02	26.23	14.15	11.90	31.85	0 of 33
PHENANTHRENE	1.64	1.70	1.67	1.53	1.99	3.06	3.31	2.01	0.29	0.28	2.80	0.28	1.73	5.54	5 of 33
PHENOL	3.28	3.40	3.34	5.46	3.99	3.86	5.38	4.89	5.81	5.61	10.49	5.66	4.91	12.74	1 of 33
PYRENE	1.64	1.70	1.67	1.53	1.99	1.93	2.69	2.44	2.90	2.80	5.25	2.83	2.38	6.37	0 of 33

Table A-3 Deer Island Influent Loadings, Fiscal Year 1998, cont.

Volatile Organics (lbs/day)	Jul	Aug	Sep	Oct	Nov	Dec	Jan	Feb	Mar	Apr	May	Jun	Average	Maximum	Times Detected
1,1,1-TRICHLOROETHANE	0.79	0.83	0.76	0.70	1.02	0.89	1.43	1.11	1.33	1.31	2.66	1.36	1.11	2.84	0 of 39
1,1,2,2-TETRACHLOROETHANE	0.79	0.83	0.76	0.70	1.02	0.89	1.43	1.11	1.33	1.31	2.66	1.36	1.11	2.84	0 of 39
1,1,2-TRICHLOROETHANE	0.79	0.83	0.76	0.70	1.02	0.89	1.43	1.11	1.33	1.31	2.66	1.36	1.11	2.84	0 of 39
1,1-DICHLOROETHANE	0.79	0.83	0.76	0.70	1.02	0.89	1.43	1.11	1.33	1.31	2.66	1.36	1.11	2.84	0 of 39
1,1-DICHLOROETHENE	0.79	0.83	0.76	0.70	1.02	0.89	1.43	1.11	1.33	1.31	2.66	1.36	1.11	2.84	0 of 39
1,2-DICHLOROBENZENE	0.79	0.83	0.76	0.70	1.02	0.89	1.43	1.11	1.33	1.31	2.66	1.36	1.11	2.84	0 of 39
1,2-DICHLOROETHANE	0.79	0.83	0.76	0.70	1.02	0.89	1.43	1.11	1.33	1.31	2.66	1.36	1.11	2.84	0 of 39
1,2-DICHLOROPROPANE	0.79	0.83	0.76	3.82	1.02	0.89	1.43	1.11	1.33	1.31	2.66	1.36	1.27	6.92	1 of 39
1,3-DICHLOROBENZENE	0.79	0.83	1.50	0.70	1.02	0.89	1.43	1.11	1.33	1.31	2.66	1.36	1.17	3.01	1 of 39
1,4-DICHLOROBENZENE	3.40	3.76	3.15	0.70	1.02	0.89	1.43	1.11	1.33	1.31	2.66	1.36	2.02	4.16	13 of 39
2-BUTANONE	2.29	0.83	21.20	0.70	1.02	2.90	1.43	1.11	4.82	1.31	2.66	8.78	3.98	57.24	7 of 39
2-CHLOROETHYL VINYL ETHER	0.79	0.83	0.76	0.70	1.02	0.89	1.43	1.11	1.33	1.31	2.66	1.36	1.11	2.84	0 of 39
2-HEXANONE	0.79	0.83	0.76	0.70	1.02	0.89	1.43	1.11	1.33	1.31	2.66	1.36	1.11	2.84	0 of 39
4-METHYL-2-PENTANONE	0.79	0.83	0.76	0.70	1.02	2.30	1.43	1.11	1.33	1.31	2.66	1.36	1.22	5.10	1 of 39
ACETONE	265.69	288.13	211.88	172.39	196.10	337.86	270.38	215.68	308.91	387.12	930.49	390.20	308.31	1241.70	39 of 39
ACROLEIN	0.79	0.83	0.76	0.70	1.02	0.89	1.43	1.11	1.33	1.31	2.66	1.36	1.11	2.84	0 of 39
ACRYLONITRILE	0.79	0.83	0.76	0.70	1.02	0.89	1.43	1.11	1.33	1.31	2.66	1.36	1.11	2.84	0 of 39
BENZENE	2.06	2.22	1.16	0.70	1.02	0.89	1.43	1.11	1.33	1.31	2.66	1.36	1.49	5.14	7 of 39
BROMODICHLOROMETHANE	1.93	0.83	0.76	0.70	1.02	0.89	1.43	1.11	1.33	1.31	2.66	1.36	1.29	7.62	1 of 39
BROMOFORM	0.79	0.83	0.76	0.70	1.02	0.89	1.43	1.11	1.33	1.31	2.66	1.36	1.11	2.84	0 of 39
BROMOMETHANE	0.79	0.83	0.76	0.70	1.02	0.89	1.43	1.11	1.33	1.31	2.66	1.36	1.11	2.84	0 of 39
CARBON DISULFIDE	30.53	2.90	4.34	4.55	5.79	6.21	5.18	1.11	1.33	1.31	2.66	1.36	7.73	144.52	18 of 39
CARBON TETRACHLORIDE	0.79	0.83	0.76	0.70	1.02	0.89	1.43	1.11	1.33	1.31	2.66	1.36	1.11	2.84	0 of 39
CHLOROBENZENE	0.79	0.83	0.76	0.70	1.02	0.89	1.43	1.11	1.33	1.31	2.66	1.36	1.11	2.84	0 of 39
CHLOROETHANE	0.79	0.83	0.76	0.70	1.02	0.89	1.43	1.11	1.33	1.31	2.66	1.36	1.11	2.84	0 of 39
CHLOROFORM	8.93	7.77	5.70	8.32	14.17	10.99	11.70	10.27	14.73	20.17	42.41	24.00	13.56	46.30	39 of 39
CHLOROMETHANE	0.79	0.83	0.76	0.70	1.02	0.89	1.43	1.11	1.33	1.31	2.66	1.36	1.11	2.84	0 of 39
CIS-1,2-DICHLOROETHENE	3.91	3.37	3.56	2.52	4.80	6.17	2.79	2.55	3.04	1.31	2.66	5.48	3.68	8.35	26 of 39
CIS-1,3-DICHLOROPROPENE	0.79	0.83	0.76	0.70	1.02	0.89	1.43	1.11	1.33	1.31	2.66	1.36	1.11	2.84	0 of 39
DIBROMOCHLOROMETHANE	0.79	0.83	0.76	0.70	1.02	0.89	1.43	1.11	1.33	1.31	2.66	1.36	1.11	2.84	0 of 39
ETHYLBENZENE	4.04	3.00	1.95	0.70	2.32	0.89	1.43	1.11	1.33	1.31	2.66	1.36	2.08	10.52	8 of 39
M,P-XYLENE	14.41	11.09	7.95	3.09	3.28	10.19	1.43	2.65	1.33	1.31	10.05	1.36	6.51	37.03	21 of 39
METHYLENE CHLORIDE	6.08	6.03	10.00	5.22	4.86	6.35	4.41	7.75	6.06	9.60	18.71	4.10	6.92	34.94	27 of 39
O-XYLENE	5.37	5.17	3.81	0.70	1.02	3.23	1.43	1.11	1.33	1.31	2.66	1.36	2.71	17.31	10 of 39
STYRENE	0.79	0.83	0.76	0.70	1.02	0.89	1.43	1.11	1.33	1.31	17.65	1.36	1.90	32.45	1 of 39
TETRACHLOROETHENE	5.18	6.50	9.24	3.17	14.05	5.50	20.21	12.32	10.63	16.08	9.93	8.93	9.79	25.14	34 of 39
TOLUENE	19.78	22.26	19.13	9.43	9.96	14.25	10.49	6.97	8.58	8.60	22.94	12.20	14.33	56.46	39 of 39
TRANS-1,2-DICHLOROETHENE	0.79	0.83	0.76	0.70	1.02	0.89	1.43	1.11	1.33	1.31	2.66	1.36	1.11	2.84	0 of 39
TRANS-1,3-DICHLOROPROPENE	0.79	0.83	0.76	0.70	1.02	0.89	1.43	1.11	1.33	1.31	2.66	1.36	1.11	2.84	0 of 39
TRICHLOROETHENE	4.94	4.08	4.66	3.13	7.92	6.70	7.31	5.46	6.60	4.15	2.66	2.48	5.19	13.73	29 of 39
TRICHLOROFUOROMETHANE	0.79	0.83	0.76	0.70	1.02	0.89	1.43	1.11	1.33	1.31	2.66	1.36	1.11	2.84	0 of 39
VINYL ACETATE	0.79	0.83	0.76	0.70	1.02	0.89	1.43	1.11	1.33	1.31	2.66	1.36	1.11	2.84	0 of 39
VINYL CHLORIDE	0.79	0.83	0.76	0.70	1.02	0.89	1.43	1.11	1.33	1.31	2.66	1.36	1.11	2.84	0 of 39

Table A-4 Deer Island Effluent Characterization, Fiscal Year 1998

Metals (ug/L)													Times		
	Jul	Aug	Sep	Oct	Nov	Dec	Jan	Feb	Mar	Apr	May	Jun	Average	Maximum	Detected
ANTIMONY	18.73	20.00	20.00	20.00	20.00	20.00	20.00	20.00	20.00	20.00	20.00	20.00	19.94	20.00	0 of 90
ARSENIC	1.10	1.10	1.10	1.10	1.10	0.53	0.71	0.40	1.18	0.67	0.70	0.67	0.85	2.43	15 of 90
BERYLLIUM	0.50	0.50	0.50	0.50	0.50	0.50	0.50	0.50	0.50	0.50	0.50	0.50	0.50	0.50	0 of 89
BORON	264.89	265.29	332.07	301.33	203.43	202.71	147.79	191.87	137.39	125.00	149.33	136.14	184.35	618.00	43 of 90
CADMIUM	1.00	1.00	1.00	1.00	1.00	1.00	1.00	1.00	1.17	1.00	1.00	1.00	1.02	2.38	1 of 90
CHROMIUM	3.18	2.20	1.88	3.29	2.49	2.02	5.66	1.77	2.11	1.73	1.50	1.85	2.35	14.00	30 of 92
COPPER	46.14	38.89	26.65	12.47	27.25	27.81	38.59	36.61	30.13	21.22	19.55	19.59	27.56	110.00	80 of 91
HEXAVALENT CHROMIUM	5.50	5.50	5.50	5.50	5.50	5.50	5.50	5.50	5.50	5.50	12.30	5.50	6.65	26.00	1 of 39
IRON	946.87	896.44	682.67	531.51	697.22	646.69	730.60	530.43	725.41	281.31	444.0	788.61	650.19	2250.00	90 of 90
LEAD	6.09	8.74	6.24	3.65	6.35	4.98	5.54	3.34	8.63	1.40	4.16	4.21	5.29	25.60	77 of 90
MERCURY	0.09	0.10	0.06	0.07	0.08	0.08	0.04	0.04	0.08	0.04	0.06	0.07	0.07	0.39	56 of 92
MOLYBDENUM	16.96	14.56	16.30	16.67	10.96	6.81	6.64	6.38	5.32	7.20	8.65	7.14	9.01	39.00	75 of 90
NICKEL	6.81	4.00	4.00	4.00	4.00	4.00	4.00	4.00	4.00	4.00	4.00	4.00	4.12	18.60	2 of 90
SELENIUM	1.10	1.10	1.10	1.10	0.97	0.60	0.45	0.45	0.51	0.75	0.45	0.61	0.71	1.83	2 of 90
SILVER	2.41	1.50	1.38	1.15	1.67	2.21	1.07	0.95	1.06	0.90	1.06	0.88	1.26	6.11	47 of 89
THALLIUM	1.10	1.10	1.10	1.10	0.98	0.50	0.50	0.60	0.50	0.74	0.50	0.57	0.71	1.20	4 of 90
ZINC	61.53	58.33	38.61	29.63	55.77	47.13	53.11	45.04	55.22	32.52	41.78	40.54	46.57	119.00	90 of 91

Cyanide and Phenols (ug/L)													Times		
	Jul	Aug	Sep	Oct	Nov	Dec	Jan	Feb	Mar	Apr	May	Jun	Average	Maximum	Detected
CYANIDE	10.46	5.00	5.00	5.00	6.03	12.35	5.00	5.00	5.00	5.00	5.00	5.00	5.88	20.90	4 of 39
TOTAL PHENOLS	23.34	6.93	21.97	5.45	7.07	10.39	6.65	1.00	1.00	1.00	1.00	6.09	6.21	26.00	14 of 39

Oil and Grease, Petroleum Hydrocarbons, and Surfactants (mg/L)													Times		
	Jul	Aug	Sep	Oct	Nov	Dec	Jan	Feb	Mar	Apr	May	Jun	Average	Maximum	Detected
PETROLEUM HYDROCARBON	2.86	0.19	0.76	0.70	0.57	0.50	0.54	0.44	0.25	0.27	0.43	0.51	0.57	12.00	71 of 72
TOTAL PETROLEUM HYDROCARBON	2.76	1.77	3.36	2.36	1.90	0.88	0.96	0.39	0.39	0.55	2.24	1.10	1.37	4.99	50 of 75
FATS OIL AND GREASE	21.15	14.50	11.09	5.85	10.69	4.49	5.65	9.47	10.52	2.16	2.98	5.89	8.13	30.40	43 of 77
MBAS	5.82	2.27	1.67	1.58	2.49	1.33	2.12	1.31	1.47	0.38	0.86	1.42	1.67	9.44	40 of 40

Table A-4 Deer Island Effluent Characterization, Fiscal Year 1998, cont.

Organochlorine Pesticides and PCBs (ug/L)	Jul	Aug	Sep	Oct	Nov	Dec	Jan	Feb	Mar	Apr	May	Jun	Average	Maximum	Times Detected
4,4'-DDD	0.002	0.002	0.002	0.002	0.002	0.002	0.009	0.002	0.002	0.002	0.002	0.002	0.003	0.018	2 of 42
4,4'-DDE	0.006	0.002	0.002	0.002	0.002	0.002	0.002	0.002	0.002	0.002	0.002	0.002	0.002	0.022	1 of 42
4,4'-DDT	0.002	0.002	0.002	0.002	0.002	0.002	0.028	0.002	0.002	0.002	0.002	0.002	0.004	0.056	3 of 42
ALDRIN	0.002	0.002	0.002	0.002	0.002	0.002	0.002	0.002	0.002	0.002	0.002	0.002	0.002	0.002	0 of 42
ALPHA-BHC	0.002	0.002	0.002	0.002	0.002	0.002	0.002	0.002	0.002	0.002	0.002	0.002	0.002	0.002	0 of 42
ALPHA-CHLORDANE	0.004	0.002	0.002	0.002	0.002	0.002	0.002	0.002	0.002	0.002	0.002	0.002	0.002	0.011	1 of 42
AROCLOR-1016	0.053	0.053	0.054	0.051	0.054	0.053	0.052	0.054	0.052	0.054	0.052	0.052	0.053	0.060	0 of 42
AROCLOR-1221	0.105	0.106	0.108	0.101	0.107	0.105	0.103	0.108	0.104	0.109	0.104	0.104	0.106	0.119	0 of 42
AROCLOR-1232	0.053	0.053	0.054	0.051	0.054	0.053	0.052	0.054	0.052	0.054	0.052	0.052	0.053	0.060	0 of 42
AROCLOR-1242	0.053	0.053	0.054	0.051	0.054	0.053	0.052	0.054	0.052	0.054	0.052	0.052	0.053	0.060	0 of 42
AROCLOR-1248	0.053	0.053	0.054	0.051	0.054	0.053	0.052	0.054	0.052	0.054	0.052	0.052	0.053	0.060	0 of 42
AROCLOR-1254	0.053	0.053	0.054	0.051	0.054	0.053	0.052	0.054	0.052	0.054	0.052	0.052	0.053	0.060	0 of 42
AROCLOR-1260	0.053	0.053	0.054	0.051	0.054	0.053	0.052	0.054	0.052	0.054	0.052	0.052	0.053	0.060	0 of 42
BETA-BHC	0.002	0.002	0.002	0.002	0.002	0.002	0.002	0.002	0.002	0.002	0.002	0.002	0.002	0.002	0 of 42
CHLORDANE (TECHNICAL)	0.053	0.053	0.054	0.051	0.054	0.053	0.052	0.054	0.052	0.054	0.052	0.052	0.053	0.060	0 of 42
DELTA-BHC	0.002	0.002	0.002	0.002	0.002	0.002	0.002	0.002	0.002	0.002	0.002	0.002	0.002	0.002	0 of 42
DIELDRIN	0.004	0.002	0.002	0.002	0.002	0.002	0.002	0.002	0.002	0.002	0.002	0.002	0.002	0.014	1 of 42
ENDOSULFAN I	0.002	0.002	0.002	0.002	0.002	0.002	0.002	0.002	0.002	0.002	0.002	0.002	0.002	0.002	0 of 42
ENDOSULFAN II	0.002	0.002	0.002	0.002	0.002	0.002	0.002	0.002	0.002	0.002	0.002	0.002	0.002	0.002	0 of 42
ENDOSULFAN SULFATE	0.002	0.002	0.002	0.002	0.002	0.002	0.002	0.002	0.002	0.002	0.002	0.002	0.002	0.002	0 of 42
ENDRIN	0.002	0.002	0.002	0.002	0.002	0.002	0.002	0.002	0.002	0.002	0.002	0.002	0.002	0.002	0 of 42
ENDRIN ALDEHYDE	0.002	0.002	0.002	0.002	0.002	0.002	0.002	0.002	0.002	0.002	0.002	0.002	0.002	0.002	0 of 42
ENDRIN KETONE	0.002	0.002	0.002	0.002	0.002	0.002	0.002	0.002	0.002	0.002	0.002	0.002	0.002	0.002	0 of 42
GAMMA-BHC (LINDANE)	0.002	0.002	0.002	0.002	0.002	0.002	0.002	0.002	0.002	0.002	0.002	0.002	0.002	0.002	0 of 42
GAMMA-CHLORDANE	0.002	0.002	0.002	0.002	0.002	0.002	0.002	0.002	0.002	0.002	0.002	0.002	0.002	0.002	0 of 42
HEPTACHLOR	0.002	0.002	0.002	0.002	0.002	0.002	0.002	0.002	0.002	0.002	0.002	0.002	0.002	0.002	0 of 42
HEPTACHLOR EPOXIDE	0.002	0.002	0.002	0.002	0.002	0.002	0.002	0.002	0.002	0.002	0.002	0.002	0.002	0.002	0 of 42
METHOXYCHLOR	0.021	0.021	0.022	0.020	0.021	0.021	0.021	0.022	0.021	0.022	0.021	0.021	0.021	0.024	0 of 42
TOXAPHENE	0.053	0.053	0.054	0.051	0.054	0.053	0.052	0.054	0.052	0.054	0.052	0.052	0.053	0.060	0 of 42

Table A-4 Deer Island Effluent Characterization, Fiscal Year 1998, cont.

Semivolatile Organics (ug/L)													Times		
	Jul	Aug	Sep	Oct	Nov	Dec	Jan	Feb	Mar	Apr	May	Jun	Average	Maximum	Detected
1,2,4-TRICHLOROBENZENE	1.04	1.04	1.08	1.03	1.20	1.03	1.11	1.09	1.03	1.06	1.02	1.08	1.07	2.08	0 of 41
1,2-DICHLOROBENZENE	1.04	1.04	1.08	1.03	1.20	1.03	1.11	1.09	1.03	1.06	1.02	1.08	1.07	2.08	0 of 41
1,2-DIPHENYLHYDRAZINE (AS AZOB)	1.04	1.04	1.08	1.03	1.20	1.03	1.11	1.09	1.03	1.06	1.02	1.08	1.07	2.08	0 of 41
1,3-DICHLOROBENZENE	1.04	1.04	1.08	1.03	1.20	1.03	1.11	1.09	1.03	1.06	1.02	1.08	1.07	2.08	0 of 41
1,4-DICHLOROBENZENE	1.04	1.04	1.08	1.03	1.20	1.03	1.11	1.09	1.03	1.06	1.02	1.08	1.07	2.08	0 of 41
2,2'-OXYBIS(1-CHLOROPROPANE)	1.04	1.04	1.08	1.03	1.20	1.03	1.11	1.09	1.03	1.06	1.02	1.08	1.07	2.08	0 of 41
2,4,5-TRICHLOROPHENOL	1.04	1.04	1.08	1.03	1.20	1.03	1.11	1.09	1.03	1.06	1.02	1.08	1.07	2.08	0 of 41
2,4,6-TRICHLOROPHENOL	1.04	1.04	1.08	1.03	1.20	1.03	1.11	1.09	1.03	1.06	1.02	1.08	1.07	2.08	0 of 41
2,4-DICHLOROPHENOL	1.04	1.04	1.08	1.03	1.20	1.03	1.11	1.09	1.03	1.06	1.02	1.08	1.07	2.08	0 of 41
2,4-DIMETHYLPHENOL	1.04	1.04	1.08	1.03	1.20	1.03	1.11	1.09	1.03	1.06	1.02	1.08	1.07	2.08	0 of 41
2,4-DINITROPHENOL	2.07	2.08	2.15	2.07	2.40	2.06	2.22	2.17	2.07	2.13	2.03	2.15	2.15	4.16	0 of 41
2,4-DINITROTOLUENE	1.04	1.04	1.08	1.03	1.20	1.03	1.11	1.09	1.03	1.06	1.02	1.08	1.07	2.08	0 of 41
2,6-DINITROTOLUENE	1.04	1.04	1.08	1.03	1.20	5.96	1.11	1.09	1.03	1.06	1.02	1.08	1.37	16.62	1 of 41
2-CHLORONAPHTHALENE	1.04	1.04	1.08	1.03	1.20	1.03	1.11	1.09	1.03	1.06	1.02	1.08	1.07	2.08	0 of 41
2-CHLOROPHENOL	1.04	1.04	1.08	1.03	1.20	1.03	1.11	1.09	1.03	1.06	1.02	1.08	1.07	2.08	0 of 41
2-METHYL-4,6-DINITROPHENOL	10.36	10.41	10.77	10.34	12.00	10.32	11.12	10.87	10.35	10.64	10.17	10.75	10.73	20.80	0 of 41
2-METHYLNAPHTHALENE	1.04	1.04	1.08	1.03	1.20	1.03	1.11	1.09	1.03	1.06	1.02	1.08	1.07	2.08	0 of 41
2-METHYLPHENOL	1.04	1.04	1.08	1.03	1.20	1.03	1.11	1.09	1.03	1.06	1.02	1.08	1.07	2.08	0 of 41
2-NITROANILINE	1.04	1.04	1.08	1.03	1.20	1.03	1.11	1.09	1.03	1.06	1.02	1.08	1.07	2.08	0 of 41
2-NITROPHENOL	1.04	1.04	1.08	1.03	1.20	1.03	1.11	1.09	1.03	1.06	1.02	1.08	1.07	2.08	0 of 41
3,3'-DICHLOROBENZIDINE	2.09	2.08	2.15	2.07	2.40	2.06	2.22	2.17	2.07	2.13	2.03	2.15	2.15	4.16	0 of 41
3-NITROANILINE	1.04	1.04	1.08	1.03	1.20	1.03	1.11	1.09	1.03	1.06	1.02	1.08	1.07	2.08	0 of 41
4-BROMOPHENYL PHENYL ETHER	1.04	1.04	1.08	1.03	1.20	1.03	1.11	1.09	1.03	1.06	1.02	1.08	1.07	2.08	0 of 41
4-CHLORO-3-METHYLPHENOL	1.04	1.04	1.08	1.03	1.20	1.03	1.11	1.09	1.03	1.06	1.02	1.08	1.07	2.08	0 of 41
4-CHLOROANILINE	1.04	1.04	1.08	1.03	1.20	1.03	1.11	1.09	1.03	1.06	1.02	1.08	1.07	2.08	0 of 41
4-CHLOROPHENYL PHENYL ETHER	1.04	1.04	1.08	1.03	1.20	1.03	1.11	1.09	1.03	1.06	1.02	1.08	1.07	2.08	0 of 41
4-METHYLPHENOL (INCLUDES 3-MET)	15.05	11.14	7.55	1.03	9.70	1.03	2.35	1.09	1.03	1.06	1.02	1.08	3.94	31.60	14 of 41
4-NITROANILINE	1.04	1.04	1.08	1.03	1.20	1.03	1.11	1.09	1.03	1.06	1.02	1.08	1.07	2.08	0 of 41
4-NITROPHENOL	2.07	2.08	2.15	2.07	2.40	2.06	2.22	2.17	2.07	2.13	2.03	2.15	2.15	4.16	0 of 41
ACENAPHTHENE	1.04	1.04	1.08	1.03	1.20	1.03	1.11	1.09	1.03	1.06	1.02	1.08	1.07	2.08	0 of 41
ACENAPHTHYLENE	1.04	1.04	1.08	1.03	1.20	1.03	1.11	1.09	1.03	1.06	1.02	1.08	1.07	2.08	0 of 41
ANILINE	1.04	1.04	1.08	1.03	1.20	1.03	1.11	1.09	1.03	1.06	1.02	1.08	1.07	2.08	0 of 41
ANTHRACENE	1.04	1.04	1.08	1.03	1.20	1.03	1.11	1.09	1.03	1.06	1.02	1.08	1.07	2.08	0 of 41
BENZIDINE	5.18	5.20	5.39	5.17	6.00	5.16	5.56	5.43	5.17	5.32	5.08	5.38	5.37	10.40	0 of 41
BENZO(A)ANTHRACENE	1.04	1.04	1.08	1.03	1.20	1.03	1.11	1.09	1.03	1.06	1.02	1.08	1.07	2.08	0 of 41

Table A-4 Deer Island Effluent Characterization, Fiscal Year 1998, cont.

Semivolatile Organics (ug/L)	Jul	Aug	Sep	Oct	Nov	Dec	Jan	Feb	Mar	Apr	May	Jun	Average	Maximum	Times Detected
BENZO(A)PYRENE	1.04	1.04	1.08	1.03	1.20	1.03	1.11	1.09	1.03	1.06	1.02	1.08	1.07	2.08	0 of 41
BENZO(B)FLUORANTHENE	1.04	1.04	1.08	1.03	1.20	1.03	1.11	1.09	1.03	1.06	1.02	1.08	1.07	2.08	0 of 41
BENZO(GHI)PERYLENE	1.04	1.04	1.08	1.03	1.20	1.03	1.11	1.09	1.03	1.06	1.02	1.08	1.07	2.08	0 of 41
BENZO(K)FLUORANTHENE	1.04	1.04	1.08	1.03	1.20	1.03	1.11	1.09	1.03	1.06	1.02	1.08	1.07	2.08	0 of 41
BENZOIC ACID	23.77	2.08	2.15	2.07	5.42	2.06	2.22	2.17	2.07	2.13	2.03	2.15	3.70	47.50	4 of 41
BENZYL ALCOHOL	6.13	2.71	4.51	1.03	4.35	1.03	1.11	1.09	1.03	1.06	1.02	1.08	2.03	12.30	7 of 41
BIS(2-CHLOROETHOXY)METHANE	1.04	1.04	1.08	1.03	1.20	1.03	1.11	1.09	1.03	1.06	1.02	1.08	1.07	2.08	0 of 41
BIS(2-CHLOROETHYL)ETHER	1.04	1.04	1.08	1.03	1.20	1.03	1.11	1.09	1.03	1.06	1.02	1.08	1.07	2.08	0 of 41
BIS(2-ETHYLHEXYL)PHTHALATE	2.92	1.04	4.10	1.03	3.70	1.03	1.11	1.09	1.03	1.06	1.02	1.08	1.66	14.00	4 of 41
BUTYL BENZYL PHTHALATE	1.04	1.04	1.08	1.03	1.20	1.03	1.11	1.09	1.03	1.06	1.02	1.08	1.07	2.08	0 of 41
CHRYSENE	1.04	1.04	1.08	1.03	1.20	1.03	1.11	1.09	1.03	1.06	1.02	1.08	1.07	2.08	0 of 41
DIBENZO(A,H)ANTHRACENE	1.04	1.04	1.08	1.03	1.20	1.03	1.11	1.09	1.03	1.06	1.02	1.08	1.07	2.08	0 of 41
DIBENZOFURAN	1.04	1.04	1.08	1.03	1.20	1.03	1.11	1.09	1.03	1.06	1.02	1.08	1.07	2.08	0 of 41
DIETHYL PHTHALATE	1.04	1.04	1.08	1.03	1.20	1.03	1.11	1.09	1.03	1.06	1.02	1.08	1.07	2.08	0 of 41
DIMETHYL PHTHALATE	1.04	1.04	1.08	1.03	1.20	1.03	1.11	1.09	1.03	1.06	1.02	1.08	1.07	2.08	0 of 41
DI-N-BUTYLPHTHALATE	1.04	1.04	1.08	1.03	1.20	1.03	1.11	1.09	1.03	1.06	1.02	1.08	1.07	2.08	0 of 41
DI-N-OCTYLPHTHALATE	1.04	1.04	1.08	1.03	1.20	1.03	1.11	1.09	1.03	1.06	1.02	1.08	1.07	2.08	0 of 41
FLUORANTHENE	1.04	1.04	1.08	1.03	1.20	1.03	1.11	1.09	1.03	1.06	1.02	1.08	1.07	2.08	0 of 41
FLUORENE	1.04	1.04	1.08	1.03	1.20	1.03	1.11	1.09	1.03	1.06	1.02	1.08	1.07	2.08	0 of 41
HEXACHLOROENZENE	1.04	1.04	1.08	1.03	1.20	1.03	1.11	1.09	1.03	1.06	1.02	1.08	1.07	2.08	0 of 41
HEXACHLOROBUTADIENE	1.04	1.04	1.08	1.03	1.20	1.03	1.11	1.09	1.03	1.06	1.02	1.08	1.07	2.08	0 of 41
HEXACHLOROCYCLOPENTADIENE	5.18	5.20	5.39	5.17	6.00	5.16	5.56	5.43	5.17	5.32	5.08	5.38	5.37	10.40	0 of 41
HEXACHLOROETHANE	1.04	1.04	1.08	1.03	1.20	1.03	1.11	1.09	1.03	1.06	1.02	1.08	1.07	2.08	0 of 41
INDENO(1,2,3-CD)PYRENE	1.04	1.04	1.08	1.03	1.20	1.03	1.11	1.09	1.03	1.06	1.02	1.08	1.07	2.08	0 of 41
ISOPHORONE	1.04	1.04	1.08	1.03	1.20	1.03	1.11	1.09	1.03	1.06	1.02	1.08	1.07	2.08	0 of 41
NAPHTHALENE	1.04	1.04	1.08	1.03	1.20	1.03	1.11	1.09	1.03	1.06	1.02	1.08	1.07	2.08	0 of 41
NITROBENZENE	1.04	1.04	1.08	1.03	1.20	1.03	1.11	1.09	1.03	1.06	1.02	1.08	1.07	2.08	0 of 41
N-NITROSODIMETHYLAMINE	1.04	1.04	1.08	1.03	1.20	1.03	1.11	1.09	1.03	1.06	1.02	1.08	1.07	2.08	0 of 41
N-NITROSODI-N-PROPYLAMINE	1.04	1.04	1.08	1.03	1.20	1.00	1.11	1.09	1.03	1.06	1.02	1.08	1.07	2.08	0 of 41
N-NITROSODIPHENYLAMINE	1.04	1.04	1.08	1.03	1.20	1.03	1.11	1.09	1.03	1.06	1.02	1.08	1.07	2.08	0 of 41
PENTACHLOROPHENOL	5.18	5.20	5.39	5.17	6.00	5.16	5.56	5.43	5.17	5.32	5.08	5.38	5.37	10.40	0 of 41
PHENANTHRENE	1.04	1.04	1.08	1.03	1.20	1.03	0.37	0.11	0.10	0.11	0.10	0.11	0.53	2.08	0 of 41
PHENOL	2.07	2.08	2.15	2.07	2.40	2.06	2.22	2.17	2.07	2.13	2.03	2.15	2.15	4.16	0 of 41
PYRENE	1.04	1.04	1.08	1.03	1.20	1.03	1.11	1.09	1.03	1.06	1.02	1.08	1.07	2.08	0 of 41

Table A-4 Deer Island Effluent Characterization, Fiscal Year 1998, cont.

Volatile Organics (ug/L)													Average		Maximum		Times
	Jul	Aug	Sep	Oct	Nov	Dec	Jan	Feb	Mar	Apr	May	Jun			Detected		
1,1,1-TRICHLOROETHANE	0.50	0.40	0.50	0.50	0.50	0.50	0.50	0.50	0.50	0.50	5.53	0.50	1.26	12.90	1 of 41		
1,1,2,2-TETRACHLOROETHANE	0.50	0.40	0.50	0.50	0.50	0.50	0.50	0.50	0.50	0.50	0.50	0.50	0.49	0.50	0 of 41		
1,1,2-TRICHLOROETHANE	0.50	0.40	0.50	0.50	0.50	0.50	0.50	0.50	0.50	0.50	0.50	0.50	0.49	0.50	0 of 41		
1,1-DICHLOROETHANE	0.50	0.40	0.50	0.50	0.50	0.50	0.50	0.50	0.50	0.50	0.50	0.50	0.49	0.50	0 of 41		
1,1-DICHLOROETHENE	0.50	0.40	0.50	0.50	0.50	0.50	0.50	0.50	0.50	0.50	0.50	0.50	0.49	0.50	0 of 41		
1,2-DICHLOROBENZENE	0.50	0.40	0.50	0.50	0.50	0.50	0.50	0.50	0.50	0.50	0.50	0.50	0.49	0.50	0 of 41		
1,2-DICHLOROETHANE	0.50	0.40	0.50	0.50	0.50	0.50	0.50	0.50	0.50	0.50	0.50	0.50	0.49	0.50	0 of 41		
1,2-DICHLOROPROPANE	0.50	0.40	0.50	0.50	0.50	0.50	0.50	0.50	0.50	0.50	0.50	0.50	0.49	0.50	0 of 41		
1,3-DICHLOROBENZENE	0.50	0.40	0.50	0.50	0.50	0.50	0.50	0.50	0.50	0.50	0.50	0.50	0.49	0.50	0 of 41		
1,4-DICHLOROBENZENE	1.72	2.00	1.92	1.02	0.94	0.50	0.50	0.50	0.50	0.50	0.50	0.50	0.85	2.61	14 of 41		
2-BUTANONE	1.46	21.36	0.50	0.50	1.40	0.50	0.50	2.35	0.50	0.50	0.50	4.22	2.65	70.10	5 of 41		
2-CHLOROETHYL VINYL ETHER	0.50	0.40	0.50	0.50	0.50	0.50	0.50	0.50	0.50	0.50	0.50	0.50	0.49	0.50	0 of 41		
2-HEXANONE	0.50	0.40	0.50	0.50	0.50	0.50	0.50	0.50	0.50	0.50	0.50	0.50	0.49	0.50	0 of 41		
4-METHYL-2-PENTANONE	0.50	0.40	0.50	0.50	0.50	0.50	0.50	0.50	0.50	0.50	0.50	0.50	0.49	0.50	0 of 41		
ACETONE	162.44	151.56	73.76	68.43	71.61	61.38	83.74	85.27	76.23	10.90	43.65	54.20	76.07	333.00	40 of 41		
ACROLEIN	1.11	0.81	0.50	0.50	0.50	0.50	0.50	0.50	0.50	0.50	0.50	0.50	0.57	3.36	2 of 41		
ACRYLONITRILE	0.50	0.40	0.50	0.50	0.50	0.50	0.50	0.50	0.50	0.50	0.50	0.50	0.49	0.50	0 of 41		
BENZENE	0.61	0.40	0.50	0.50	0.50	0.50	0.50	0.50	0.50	0.50	0.50	0.50	0.50	1.10	1 of 41		
BROMODICHLOROMETHANE	0.60	1.04	0.69	0.50	1.27	0.50	0.50	1.19	0.50	1.92	0.50	1.52	0.90	4.75	8 of 41		
BROMOFORM	0.50	0.40	0.50	0.50	0.50	0.50	0.50	0.50	0.50	0.50	0.50	0.50	0.49	0.50	0 of 41		
BROMOMETHANE	0.50	0.40	0.50	0.50	0.50	0.50	0.50	0.50	0.50	0.50	0.50	0.50	0.49	0.50	0 of 41		
CARBON DISULFIDE	7.10	2.10	1.65	2.24	1.27	1.47	0.50	0.50	0.50	0.50	0.50	0.50	1.46	15.40	14 of 41		
CARBON TETRACHLORIDE	0.50	0.40	0.50	0.50	0.50	0.50	0.50	0.50	0.50	0.50	0.50	0.50	0.49	0.50	0 of 41		
CHLOROBENZENE	0.50	0.40	0.50	0.50	0.50	0.50	0.50	0.50	0.50	0.50	0.50	0.50	0.49	0.50	0 of 41		
CHLOROETHANE	0.50	0.56	1.19	0.50	0.50	0.50	0.50	0.50	0.50	0.50	0.50	0.50	0.54	1.62	3 of 41		
CHLOROFORM	9.38	9.23	8.08	7.16	7.07	7.24	4.50	7.75	6.66	8.14	7.29	10.68	7.71	16.40	40 of 41		
CHLOROMETHANE	2.65	3.54	2.97	0.50	0.50	0.50	0.50	0.50	0.50	0.50	0.50	0.50	1.85	1.15	6.75	13 of 41	
CIS-1,2-DICHLOROETHENE	1.38	0.86	0.68	0.50	0.50	0.50	0.50	0.50	0.50	0.50	0.50	0.50	0.61	1.89	7 of 41		
CIS-1,3-DICHLOROPROPENE	0.50	0.40	0.50	0.50	0.50	0.50	0.50	0.50	0.50	0.50	0.50	0.50	0.49	0.50	0 of 41		
DIBROMOCHLOROMETHANE	0.50	0.40	0.50	0.50	0.50	0.50	0.50	0.50	0.50	0.50	0.50	0.50	0.49	0.50	0 of 41		
ETHYLBENZENE	1.01	0.40	1.09	0.71	0.50	0.50	0.50	0.50	0.50	0.50	0.50	0.50	0.58	2.51	4 of 41		
M,P-XYLENE	3.24	1.65	1.34	0.68	1.27	0.50	0.50	0.50	0.50	0.50	0.50	0.50	0.95	9.35	12 of 41		
METHYLENE CHLORIDE	4.33	4.92	7.01	5.45	5.16	5.58	2.61	3.82	5.22	3.72	2.43	3.14	4.15	12.80	33 of 41		
O-XYLENE	1.72	0.40	0.50	0.50	0.50	0.50	0.50	0.50	0.50	0.50	0.50	0.50	0.60	4.55	3 of 41		

Table A-4 Deer Island Effluent Characterization, Fiscal Year 1998, cont.

Volatile Organics (ug/L)															Times
	Jul	Aug	Sep	Oct	Nov	Dec	Jan	Feb	Mar	Apr	May	Jun	Average	Maximum	Detected
STYRENE	0.50	0.40	0.50	0.50	0.50	0.50	0.50	0.50	0.50	0.50	0.50	0.50	0.49	0.50	0 of 41
TETRACHLOROETHENE	3.08	4.24	5.63	5.84	7.75	3.35	3.39	3.31	1.95	5.18	3.39	6.10	4.38	23.10	37 of 41
TOLUENE	8.80	5.26	4.55	3.25	3.96	1.21	1.39	1.94	0.50	0.50	1.47	1.18	2.70	16.60	24 of 41
TRANS-1,2-DICHLOROETHENE	0.50	0.40	0.50	0.50	0.50	0.50	0.50	0.50	0.50	0.50	0.50	0.50	0.49	0.50	0 of 41
TRANS-1,3-DICHLOROPROPENE	0.50	0.40	0.50	0.50	0.50	0.50	0.50	0.50	0.50	0.50	0.50	0.50	0.49	0.50	0 of 41
TRICHLOROETHENE	1.62	1.58	1.50	0.50	1.55	0.50	0.50	1.37	2.77	0.50	0.50	0.50	1.10	7.97	16 of 41
TRICHLOROFLUOROMETHANE	0.50	0.40	0.50	0.50	0.50	0.50	0.50	0.50	0.50	0.50	0.50	0.50	0.49	0.50	0 of 41
VINYL ACETATE	0.50	0.40	0.50	0.50	0.50	0.50	0.50	0.50	0.50	0.50	0.50	0.50	0.49	0.50	0 of 41
VINYL CHLORIDE	0.50	0.40	0.50	0.50	0.50	0.50	0.50	0.50	0.50	0.50	0.50	0.50	0.49	0.50	0 of 41

Notes:

Results in **bold italics** indicate one or more detects in the month.

Yearly averages are calculated from individual results collected in the fiscal year.

Non-detected compounds are assumed to equal one half of the detection limit for metals and inorganics and one tenth of the reporting limit for organic compounds.

Table A-5 Deer Island Effluent Loadings, Fiscal Year 1998

Metals (lbs/day)														Times	
	Jul	Aug	Sep	Oct	Nov	Dec	Jan	Feb	Mar	Apr	May	Jun	Average	Maximum	Detected
ANTIMONY	28.82	32.47	30.64	31.45	38.48	39.01	48.37	46.74	61.92	54.77	84.74	73.35	47.21	144.59	0 of 90
ARSENIC	1.69	1.79	1.69	1.73	2.12	1.04	1.73	0.93	3.65	1.83	2.96	2.46	2.01	14.06	15 of 90
BERYLLIUM	0.77	0.81	0.77	0.75	0.96	0.98	1.21	1.17	1.55	1.37	2.12	1.83	1.19	3.61	0 of 89
BORON	407.59	430.73	508.75	473.90	391.38	395.41	357.44	448.42	425.34	342.33	632.68	499.25	436.41	903.68	43 of 90
CADMIUM	1.54	1.62	1.53	1.57	1.92	1.95	2.42	2.34	3.64	2.74	4.24	3.67	2.42	7.46	1 of 90
CHROMIUM	4.90	3.57	2.88	5.18	4.79	3.93	13.69	4.13	6.54	4.75	6.36	6.79	5.57	27.21	30 of 92
COPPER	70.99	63.14	40.82	19.61	52.43	54.25	93.34	85.55	93.27	58.11	82.83	71.84	65.24	234.93	80 of 91
HEXAVALENT CHROMIUM	8.95	8.48	8.35	7.92	10.55	9.84	15.71	12.22	14.66	14.42	57.43	14.95	15.08	128.62	1 of 39
IRON	1456.95	1455.47	1045.89	835.90	1341.38	1261.42	1767.08	1239.68	2245.77	770.41	1881.16	2892.06	1539.22	8096.48	90 of 90
LEAD	9.37	14.18	9.56	5.74	12.22	9.71	13.40	7.80	26.71	3.83	17.63	15.42	12.53	148.14	77 of 90
MERCURY	0.13	0.16	0.09	0.10	0.16	0.15	0.11	0.09	0.24	0.12	0.24	0.26	0.16	0.83	56 of 92
MOLYBDENUM	26.10	23.63	24.97	26.22	21.08	13.27	16.06	14.90	16.47	19.71	36.68	26.20	21.33	58.78	75 of 90
NICKEL	10.47	6.49	6.13	6.29	7.70	7.80	9.67	9.35	12.38	10.95	16.95	14.67	9.76	28.92	2 of 90
SELENIUM	1.69	1.79	1.69	1.73	1.87	1.17	1.09	1.05	1.56	2.06	1.89	2.25	1.67	6.72	2 of 90
SILVER	3.70	2.44	2.11	1.73	3.21	4.31	2.59	2.23	3.27	2.46	4.51	3.22	2.98	10.02	47 of 89
THALLIUM	1.69	1.79	1.69	1.73	1.89	0.98	1.21	1.40	1.55	2.02	2.12	2.09	1.68	3.61	4 of 90
ZINC	94.67	94.71	59.15	46.60	107.29	91.92	128.46	105.27	170.96	89.07	177.01	148.65	110.26	478.59	90 of 91

Cyanide and Phenols (lbs/day)														Times	
	Jul	Aug	Sep	Oct	Nov	Dec	Jan	Feb	Mar	Apr	May	Jun	Average	Maximum	Detected
CYANIDE	17.02	7.71	7.59	7.20	11.56	22.09	14.28	11.11	13.32	13.11	23.34	13.59	13.35	35.06	4 of 39
TOTAL PHENOLS	36.06	11.10	34.13	8.40	13.23	18.29	16.34	2.31	2.80	2.64	4.19	16.34	13.77	45.49	14 of 39

Oil and Grease, Petroleum Hydrocarbons, and Surfactants (lbs/day)														Times	
	Jul	Aug	Sep	Oct	Nov	Dec	Jan	Feb	Mar	Apr	May	Jun	Average	Maximum	Detected
PETROLEUM HYDROCARBON	4521	296	1158	1069	1116	983	1446	1023	766	761	1745	1936	1382	18286	71 of 72
TOTAL PETROLEUM HYDROCARBON	4373	3001	5121	3625	3702	1726	2589	893	1193	1545	9056	4186	3298	17044	50 of 75
FATS OIL AND GREASE	33461	24644	16872	9136	20820	8811	15235	21769	31886	6047	9566	22494	18872	140034	43 of 77
MBAS	8990	3630	2602	2429	4658	2346	5197	3015	4108	997	4104	3806	3893	14779	40 of 40

Table A-5 Deer Island Effluent Loadings, Fiscal Year 1998, cont.

Organochlorine Pesticides and PCBs (lbs/day)	Organochlorine Pesticides and PCBs (lbs/day)												Average	Maximum	Times Detected	
	Jul	Aug	Sep	Oct	Nov	Dec	Jan	Feb	Mar	Apr	May	Jun				
4,4'-DDD	0.003	0.003	0.003	0.003	0.004	0.004	<i>0.021</i>	0.005	0.006	0.006	0.009	0.006	0.006	0.035	2	of 42
4,4'-DDE	<i>0.009</i>	0.003	0.003	0.003	0.004	0.004	0.005	0.005	0.006	0.006	0.009	0.006	0.005	0.032	1	of 42
4,4'-DDT	0.003	0.003	0.003	0.003	0.004	0.004	<i>0.070</i>	0.005	0.006	0.006	0.009	0.006	0.009	0.108	3	of 42
ALDRIN	0.003	0.003	0.003	0.003	0.004	0.004	0.005	0.005	0.006	0.006	0.009	0.006	0.005	0.012	0	of 42
ALPHA-BHC	0.003	0.003	0.003	0.003	0.004	0.004	0.005	0.005	0.006	0.006	0.009	0.006	0.005	0.012	0	of 42
ALPHA-CHLORDANE	<i>0.006</i>	0.003	0.003	0.003	0.004	0.004	0.005	0.005	0.006	0.006	0.009	0.006	0.005	0.016	1	of 42
AROCLOR-1016	0.079	0.084	0.084	0.078	0.100	0.093	0.127	0.125	0.146	0.144	0.219	0.139	0.114	0.307	0	of 42
AROCLOR-1221	0.157	0.169	0.168	0.156	0.201	0.186	0.254	0.250	0.291	0.287	0.437	0.279	0.228	0.613	0	of 42
AROCLOR-1232	0.079	0.084	0.084	0.078	0.100	0.093	0.127	0.125	0.146	0.144	0.219	0.139	0.114	0.307	0	of 42
AROCLOR-1242	0.079	0.084	0.084	0.078	0.100	0.093	0.127	0.125	0.146	0.144	0.219	0.139	0.114	0.307	0	of 42
AROCLOR-1248	0.079	0.084	0.084	0.078	0.100	0.093	0.127	0.125	0.146	0.144	0.219	0.139	0.114	0.307	0	of 42
AROCLOR-1254	0.079	0.084	0.084	0.078	0.100	0.093	0.127	0.125	0.146	0.144	0.219	0.139	0.114	0.307	0	of 42
AROCLOR-1260	0.079	0.084	0.084	0.078	0.100	0.093	0.127	0.125	0.146	0.144	0.219	0.139	0.114	0.307	0	of 42
BETA-BHC	0.003	0.003	0.003	0.003	0.004	0.004	0.005	0.005	0.006	0.006	0.009	0.006	0.005	0.012	0	of 42
CHLORDANE (TECHNICAL)	0.079	0.084	0.084	0.078	0.100	0.093	0.127	0.125	0.146	0.144	0.219	0.139	0.114	0.307	0	of 42
DELTA-BHC	0.003	0.003	0.003	0.003	0.004	0.004	0.005	0.005	0.006	0.006	0.009	0.006	0.005	0.012	0	of 42
DIELDRIN	<i>0.007</i>	0.003	0.003	0.003	0.004	0.004	0.005	0.005	0.006	0.006	0.009	0.006	0.005	0.021	1	of 42
ENDOSULFAN I	0.003	0.003	0.003	0.003	0.004	0.004	0.005	0.005	0.006	0.006	0.009	0.006	0.005	0.012	0	of 42
ENDOSULFAN II	0.003	0.003	0.003	0.003	0.004	0.004	0.005	0.005	0.006	0.006	0.009	0.006	0.005	0.012	0	of 42
ENDOSULFAN SULFATE	0.003	0.003	0.003	0.003	0.004	0.004	0.005	0.005	0.006	0.006	0.009	0.006	0.005	0.012	0	of 42
ENDRIN	0.003	0.003	0.003	0.003	0.004	0.004	0.005	0.005	0.006	0.006	0.009	0.006	0.005	0.012	0	of 42
ENDRIN ALDEHYDE	0.003	0.003	0.003	0.003	0.004	0.004	0.005	0.005	0.006	0.006	0.009	0.006	0.005	0.012	0	of 42
ENDRIN KETONE	0.003	0.003	0.003	0.003	0.004	0.004	0.005	0.005	0.006	0.006	0.009	0.006	0.005	0.012	0	of 42
GAMMA-BHC (LINDANE)	0.003	0.003	0.003	0.003	0.004	0.004	0.005	0.005	0.006	0.006	0.009	0.006	0.005	0.012	0	of 42
GAMMA-CHLORDANE	0.003	0.003	0.003	0.003	0.004	0.004	0.005	0.005	0.006	0.006	0.009	0.006	0.005	0.012	0	of 42
HEPTACHLOR	0.003	0.003	0.003	0.003	0.004	0.004	0.005	0.005	0.006	0.006	0.009	0.006	0.005	0.012	0	of 42
HEPTACHLOR EPOXIDE	0.003	0.003	0.003	0.003	0.004	0.004	0.005	0.005	0.006	0.006	0.009	0.006	0.005	0.012	0	of 42
METHOXYCHLOR	0.031	0.034	0.034	0.031	0.040	0.037	0.051	0.050	0.058	0.057	0.088	0.056	0.046	0.123	0	of 42
TOXAPHENE	0.079	0.084	0.084	0.078	0.100	0.093	0.127	0.125	0.146	0.144	0.219	0.139	0.114	0.307	0	of 42

Table A-5 Deer Island Effluent Loadings, Fiscal Year 1998, cont.

Semivolatile Organics (lbs/day)	Jul	Aug	Sep	Oct	Nov	Dec	Jan	Feb	Mar	Apr	May	Jun	Average	Maximum	Times Detected
1,2,4-TRICHLOROBENZENE	1.60	1.67	1.67	1.59	2.25	1.82	2.73	2.51	2.90	2.81	4.26	2.89	2.38	5.90	0 of 41
1,2-DICHLOROBENZENE	1.60	1.67	1.67	1.59	2.25	1.82	2.73	2.51	2.90	2.81	4.26	2.89	2.38	5.90	0 of 41
1,2-DIPHENYLHYDRAZINE (AS AZOB)	1.60	1.67	1.67	1.59	2.25	1.82	2.73	2.51	2.90	2.81	4.26	2.89	2.38	5.90	0 of 41
1,3-DICHLOROBENZENE	1.60	1.67	1.67	1.59	2.25	1.82	2.73	2.51	2.90	2.81	4.26	2.89	2.38	5.90	0 of 41
1,4-DICHLOROBENZENE	1.60	1.67	1.67	1.59	2.25	1.82	2.73	2.51	2.90	2.81	4.26	2.89	2.38	5.90	0 of 41
2,2'-OXYBIS(1-CHLOROPROPANE)	1.60	1.67	1.67	1.59	2.25	1.82	2.73	2.51	2.90	2.81	4.26	2.89	2.38	5.90	0 of 41
2,4,5-TRICHLOROPHENOL	1.60	1.67	1.67	1.59	2.25	1.82	2.73	2.51	2.90	2.81	4.26	2.89	2.38	5.90	0 of 41
2,4,6-TRICHLOROPHENOL	1.60	1.67	1.67	1.59	2.25	1.82	2.73	2.51	2.90	2.81	4.26	2.89	2.38	5.90	0 of 41
2,4-DICHLOROPHENOL	1.60	1.67	1.67	1.59	2.25	1.82	2.73	2.51	2.90	2.81	4.26	2.89	2.38	5.90	0 of 41
2,4-DIMETHYLPHENOL	1.60	1.67	1.67	1.59	2.25	1.82	2.73	2.51	2.90	2.81	4.26	2.89	2.38	5.90	0 of 41
2,4-DINITROPHENOL	3.20	3.33	3.35	3.19	4.49	3.63	5.46	5.01	5.80	5.63	8.52	5.77	4.76	11.80	0 of 41
2,4-DINITROTOLUENE	1.60	1.67	1.67	1.59	2.25	1.82	2.73	2.51	2.90	2.81	4.26	2.89	2.38	5.90	0 of 41
2,6-DINITROTOLUENE	1.60	1.67	1.67	1.59	2.25	10.50	2.73	2.51	2.90	2.81	4.26	2.89	3.05	27.71	1 of 41
2-CHLORONAPHTHALENE	1.60	1.67	1.67	1.59	2.25	1.82	2.73	2.51	2.90	2.81	4.26	2.89	2.38	5.90	0 of 41
2-CHLOROPHENOL	1.60	1.67	1.67	1.59	2.25	1.82	2.73	2.51	2.90	2.81	4.26	2.89	2.38	5.90	0 of 41
2-METHYL-4,6-DINITROPHENOL	16.01	16.66	16.74	15.93	22.47	18.17	27.29	25.06	29.00	28.14	42.58	28.85	23.80	58.98	0 of 41
2-METHYLNAPHTHALENE	1.60	1.67	1.67	1.59	2.25	1.82	2.73	2.51	2.90	2.81	4.26	2.89	2.38	5.90	0 of 41
2-METHYLPHENOL	1.60	1.67	1.67	1.59	2.25	1.82	2.73	2.51	2.90	2.81	4.26	2.89	2.38	5.90	0 of 41
2-NITROANILINE	1.60	1.67	1.67	1.59	2.25	1.82	2.73	2.51	2.90	2.81	4.26	2.89	2.38	5.90	0 of 41
2-NITROPHENOL	1.60	1.67	1.67	1.59	2.25	1.82	2.73	2.51	2.90	2.81	4.26	2.89	2.38	5.90	0 of 41
3,3'-DICHLOROBENZIDINE	3.22	3.33	3.35	3.19	4.49	3.63	5.46	5.01	5.80	5.63	8.52	5.77	4.76	11.80	0 of 41
3-NITROANILINE	1.60	1.67	1.67	1.59	2.25	1.82	2.73	2.51	2.90	2.81	4.26	2.89	2.38	5.90	0 of 41
4-BROMOPHENYL PHENYL ETHER	1.60	1.67	1.67	1.59	2.25	1.82	2.73	2.51	2.90	2.81	4.26	2.89	2.38	5.90	0 of 41
4-CHLORO-3-METHYLPHENOL	1.60	1.67	1.67	1.59	2.25	1.82	2.73	2.51	2.90	2.81	4.26	2.89	2.38	5.90	0 of 41
4-CHLOROANILINE	1.60	1.67	1.67	1.59	2.25	1.82	2.73	2.51	2.90	2.81	4.26	2.89	2.38	5.90	0 of 41
4-CHLOROPHENYL PHENYL ETHER	1.60	1.67	1.67	1.59	2.25	1.82	2.73	2.51	2.90	2.81	4.26	2.89	2.38	5.90	0 of 41
4-METHYLPHENOL (INCLUDES 3-MET)	23.26	17.82	11.73	1.59	18.16	1.82	5.78	2.51	2.90	2.81	4.26	2.89	8.74	51.82	14 of 41
4-NITROANILINE	1.60	1.67	1.67	1.59	2.25	1.82	2.73	2.51	2.90	2.81	4.26	2.89	2.38	5.90	0 of 41
4-NITROPHENOL	3.20	3.33	3.35	3.19	4.49	3.63	5.46	5.01	5.80	5.63	8.52	5.77	4.76	11.80	0 of 41
ACENAPHTHENE	1.60	1.67	1.67	1.59	2.25	1.82	2.73	2.51	2.90	2.81	4.26	2.89	2.38	5.90	0 of 41
ACENAPHTHYLENE	1.60	1.67	1.67	1.59	2.25	1.82	2.73	2.51	2.90	2.81	4.26	2.89	2.38	5.90	0 of 41
ANILINE	1.60	1.67	1.67	1.59	2.25	1.82	2.73	2.51	2.90	2.81	4.26	2.89	2.38	5.90	0 of 41
ANTHRACENE	1.60	1.67	1.67	1.59	2.25	1.82	2.73	2.51	2.90	2.81	4.26	2.89	2.38	5.90	0 of 41
BENZIDINE	8.01	8.33	8.37	7.96	11.23	9.08	13.65	12.53	14.50	14.07	21.29	14.43	11.90	29.49	0 of 41
BENZO(A)ANTHRACENE	1.60	1.67	1.67	1.59	2.25	1.82	2.73	2.51	2.90	2.81	4.26	2.89	2.38	5.90	0 of 41

Table A-5 Deer Island Effluent Loadings, Fiscal Year 1998, cont.

Semivolatile Organics (lbs/day)															Times	
	Jul	Aug	Sep	Oct	Nov	Dec	Jan	Feb	Mar	Apr	May	Jun	Average	Maximum	Detected	
BENZO(A)PYRENE	1.60	1.67	1.67	1.59	2.25	1.82	2.73	2.51	2.90	2.81	4.26	2.89	2.38	5.90	0	of 41
BENZO(B)FLUORANTHENE	1.60	1.67	1.67	1.59	2.25	1.82	2.73	2.51	2.90	2.81	4.26	2.89	2.38	5.90	0	of 41
BENZO(GHI)PERYLENE	1.60	1.67	1.67	1.59	2.25	1.82	2.73	2.51	2.90	2.81	4.26	2.89	2.38	5.90	0	of 41
BENZO(K)FLUORANTHENE	1.60	1.67	1.67	1.59	2.25	1.82	2.73	2.51	2.90	2.81	4.26	2.89	2.38	5.90	0	of 41
BENZOIC ACID	36.74	3.33	3.35	3.19	10.13	3.63	5.46	5.01	5.80	5.63	8.52	5.77	8.21	74.36	4	of 41
BENZYL ALCOHOL	9.47	4.33	7.01	1.59	8.15	1.82	2.73	2.51	2.90	2.81	4.26	2.89	4.51	20.97	7	of 41
BIS(2-CHLOROETHOXY)METHANE	1.60	1.67	1.67	1.59	2.25	1.82	2.73	2.51	2.90	2.81	4.26	2.89	2.38	5.90	0	of 41
BIS(2-CHLOROETHYL)ETHER	1.60	1.67	1.67	1.59	2.25	1.82	2.73	2.51	2.90	2.81	4.26	2.89	2.38	5.90	0	of 41
BIS(2-ETHYLHEXYL)PHTHALATE	4.51	1.67	6.36	1.59	6.93	1.82	2.73	2.51	2.90	2.81	4.26	2.89	3.68	22.96	4	of 41
BUTYL BENZYL PHTHALATE	1.60	1.67	1.67	1.59	2.25	1.82	2.73	2.51	2.90	2.81	4.26	2.89	2.38	5.90	0	of 41
CHRYSENE	1.60	1.67	1.67	1.59	2.25	1.82	2.73	2.51	2.90	2.81	4.26	2.89	2.38	5.90	0	of 41
DIBENZO(A,H)ANTHRACENE	1.60	1.67	1.67	1.59	2.25	1.82	2.73	2.51	2.90	2.81	4.26	2.89	2.38	5.90	0	of 41
DIBENZOFURAN	1.60	1.67	1.67	1.59	2.25	1.82	2.73	2.51	2.90	2.81	4.26	2.89	2.38	5.90	0	of 41
DIETHYL PHTHALATE	1.60	1.67	1.67	1.59	2.25	1.82	2.73	2.51	2.90	2.81	4.26	2.89	2.38	5.90	0	of 41
DIMETHYL PHTHALATE	1.60	1.67	1.67	1.59	2.25	1.82	2.73	2.51	2.90	2.81	4.26	2.89	2.38	5.90	0	of 41
DI-N-BUTYLPHTHALATE	1.60	1.67	1.67	1.59	2.25	1.82	2.73	2.51	2.90	2.81	4.26	2.89	2.38	5.90	0	of 41
DI-N-OCTYLPHTHALATE	1.60	1.67	1.67	1.59	2.25	1.82	2.73	2.51	2.90	2.81	4.26	2.89	2.38	5.90	0	of 41
FLUORANTHENE	1.60	1.67	1.67	1.59	2.25	1.82	2.73	2.51	2.90	2.81	4.26	2.89	2.38	5.90	0	of 41
FLUORENE	1.60	1.67	1.67	1.59	2.25	1.82	2.73	2.51	2.90	2.81	4.26	2.89	2.38	5.90	0	of 41
HEXACHLOROBENZENE	1.60	1.67	1.67	1.59	2.25	1.82	2.73	2.51	2.90	2.81	4.26	2.89	2.38	5.90	0	of 41
HEXACHLOROBUTADIENE	1.60	1.67	1.67	1.59	2.25	1.82	2.73	2.51	2.90	2.81	4.26	2.89	2.38	5.90	0	of 41
HEXACHLOROCYCLOPENTADIENE	8.01	8.33	8.37	7.96	11.23	9.08	13.65	12.53	14.50	14.07	21.29	14.43	11.90	29.49	0	of 41
HEXACHLOROETHANE	1.60	1.67	1.67	1.59	2.25	1.82	2.73	2.51	2.90	2.81	4.26	2.89	2.38	5.90	0	of 41
INDENO(1,2,3-CD)PYRENE	1.60	1.67	1.67	1.59	2.25	1.82	2.73	2.51	2.90	2.81	4.26	2.89	2.38	5.90	0	of 41
ISOPHORONE	1.60	1.67	1.67	1.59	2.25	1.82	2.73	2.51	2.90	2.81	4.26	2.89	2.38	5.90	0	of 41
NAPHTHALENE	1.60	1.67	1.67	1.59	2.25	1.82	2.73	2.51	2.90	2.81	4.26	2.89	2.38	5.90	0	of 41
NITROBENZENE	1.60	1.67	1.67	1.59	2.25	1.82	2.73	2.51	2.90	2.81	4.26	2.89	2.38	5.90	0	of 41
N-NITROSODIMETHYLAMINE	1.60	1.67	1.67	1.59	2.25	1.82	2.73	2.51	2.90	2.81	4.26	2.89	2.38	5.90	0	of 41
N-NITROSODI-N-PROPYLAMINE	1.60	1.67	1.67	1.59	2.25	1.71	2.73	2.51	2.90	2.81	4.26	2.89	2.39	5.90	0	of 40
N-NITROSODIPHENYLAMINE	1.60	1.67	1.67	1.59	2.25	1.82	2.73	2.51	2.90	2.81	4.26	2.89	2.38	5.90	0	of 41
PENTACHLOROPHENOL	8.01	8.33	8.37	7.96	11.23	9.08	13.65	12.53	14.50	14.07	21.29	14.43	11.90	29.49	0	of 41
PHENANTHRENE	1.60	1.67	1.67	1.59	2.25	1.82	0.90	0.25	0.29	0.28	0.43	0.29	1.18	3.41	0	of 41
PHENOL	3.20	3.33	3.35	3.19	4.49	3.63	5.46	5.01	5.80	5.63	8.52	5.77	4.76	11.80	0	of 41
PYRENE	1.60	1.67	1.67	1.59	2.25	1.82	2.73	2.51	2.90	2.81	4.26	2.89	2.38	5.90	0	of 41

Table A-5 Deer Island Effluent Loadings, Fiscal Year 1998, cont.

Volatile Organics (lbs/day)													Times		
	Jul	Aug	Sep	Oct	Nov	Dec	Jan	Feb	Mar	Apr	May	Jun	Average	Maximum	Detected
1,1,1-TRICHLOROETHANE	0.79	0.66	0.76	0.72	0.98	0.89	1.43	1.11	1.33	1.31	25.82	1.36	2.82	73.29	1 of 41
1,1,2,2-TETRACHLOROETHANE	0.79	0.66	0.76	0.72	0.98	0.89	1.43	1.11	1.33	1.31	2.33	1.36	1.10	2.84	0 of 41
1,1,2-TRICHLOROETHANE	0.79	0.66	0.76	0.72	0.98	0.89	1.43	1.11	1.33	1.31	2.33	1.36	1.10	2.84	0 of 41
1,1-DICHLOROETHANE	0.79	0.66	0.76	0.72	0.98	0.89	1.43	1.11	1.33	1.31	2.33	1.36	1.10	2.84	0 of 41
1,1-DICHLOROETHENE	0.79	0.66	0.76	0.72	0.98	0.89	1.43	1.11	1.33	1.31	2.33	1.36	1.10	2.84	0 of 41
1,2-DICHLOROBENZENE	0.79	0.66	0.76	0.72	0.98	0.89	1.43	1.11	1.33	1.31	2.33	1.36	1.10	2.84	0 of 41
1,2-DICHLOROETHANE	0.79	0.66	0.76	0.72	0.98	0.89	1.43	1.11	1.33	1.31	2.33	1.36	1.10	2.84	0 of 41
1,2-DICHLOROPROPANE	0.79	0.66	0.76	0.72	0.98	0.89	1.43	1.11	1.33	1.31	2.33	1.36	1.10	2.84	0 of 41
1,3-DICHLOROBENZENE	0.79	0.66	0.76	0.72	0.98	0.89	1.43	1.11	1.33	1.31	2.33	1.36	1.10	2.84	0 of 41
1,4-DICHLOROBENZENE	2.72	3.31	2.91	1.46	1.84	0.89	1.43	1.11	1.33	1.31	2.33	1.36	1.91	5.33	14 of 41
2-BUTANONE	2.31	35.35	0.76	0.72	2.75	0.89	1.43	5.22	1.33	1.31	2.33	11.48	5.93	139.76	5 of 41
2-CHLOROETHYL VINYL ETHER	0.79	0.66	0.76	0.72	0.98	0.89	1.43	1.11	1.33	1.31	2.33	1.36	1.10	2.84	0 of 41
2-HEXANONE	0.79	0.66	0.76	0.72	0.98	0.89	1.43	1.11	1.33	1.31	2.33	1.36	1.10	2.84	0 of 41
4-METHYL-2-PENTANONE	0.79	0.66	0.76	0.72	0.98	0.89	1.43	1.11	1.33	1.31	2.33	1.36	1.10	2.84	0 of 41
ACETONE	256.96	250.86	111.98	98.58	140.38	109.81	239.21	189.51	203.14	28.56	203.82	147.34	170.39	565.24	40 of 41
ACROLEIN	1.75	1.33	0.76	0.72	0.98	0.89	1.43	1.11	1.33	1.31	2.33	1.36	1.29	5.64	2 of 41
ACRYLONITRILE	0.79	0.66	0.76	0.72	0.98	0.89	1.43	1.11	1.33	1.31	2.33	1.36	1.10	2.84	0 of 41
BENZENE	0.97	0.66	0.76	0.72	0.98	0.89	1.43	1.11	1.33	1.31	2.33	1.36	1.13	2.84	1 of 41
BROMODICHLOROMETHANE	0.95	1.73	1.05	0.72	2.49	0.89	1.43	2.65	1.33	5.04	2.33	4.12	2.02	12.50	8 of 41
BROMOFORM	0.79	0.66	0.76	0.72	0.98	0.89	1.43	1.11	1.33	1.31	2.33	1.36	1.10	2.84	0 of 41
BROMOMETHANE	0.79	0.66	0.76	0.72	0.98	0.89	1.43	1.11	1.33	1.31	2.33	1.36	1.10	2.84	0 of 41
CARBON DISULFIDE	11.23	3.48	2.51	3.22	2.48	2.63	1.43	1.11	1.33	1.31	2.33	1.36	3.27	23.18	14 of 41
CARBON TETRACHLORIDE	0.79	0.66	0.76	0.72	0.98	0.89	1.43	1.11	1.33	1.31	2.33	1.36	1.10	2.84	0 of 41
CHLOROBENZENE	0.79	0.66	0.76	0.72	0.98	0.89	1.43	1.11	1.33	1.31	2.33	1.36	1.10	2.84	0 of 41
CHLOROETHANE	0.79	0.92	1.80	0.72	0.98	0.89	1.43	1.11	1.33	1.31	2.33	1.36	1.21	2.84	3 of 41
CHLOROFORM	14.84	15.27	12.26	10.31	13.86	12.96	12.86	17.23	17.74	21.35	34.02	29.04	17.27	42.74	40 of 41
CHLOROMETHANE	4.19	5.87	4.50	0.72	0.98	0.89	1.43	1.11	1.33	1.31	2.33	5.04	2.57	12.30	13 of 41
CIS-1,2-DICHLOROETHENE	2.19	1.43	1.04	0.72	0.98	0.89	1.43	1.11	1.33	1.31	2.33	1.36	1.37	3.21	7 of 41
CIS-1,3-DICHLOROPROPENE	0.79	0.66	0.76	0.72	0.98	0.89	1.43	1.11	1.33	1.31	2.33	1.36	1.10	2.84	0 of 41
DIBROMOCHLOROMETHANE	0.79	0.66	0.76	0.72	0.98	0.89	1.43	1.11	1.33	1.31	2.33	1.36	1.10	2.84	0 of 41
ETHYLBENZENE	1.60	0.66	1.66	1.03	0.98	0.89	1.43	1.11	1.33	1.31	2.33	1.36	1.29	3.78	4 of 41
M,P-XYLENE	5.13	2.74	2.03	0.98	2.50	0.89	1.43	1.11	1.33	1.31	2.33	1.36	2.13	14.08	12 of 41
METHYLENE CHLORIDE	6.84	8.15	10.64	7.85	10.12	9.98	7.45	8.50	13.92	9.75	11.35	8.53	9.30	27.65	33 of 41
O-XYLENE	2.72	0.66	0.76	0.72	0.98	0.89	1.43	1.11	1.33	1.31	2.33	1.36	1.34	6.85	3 of 41
STYRENE	0.79	0.66	0.76	0.72	0.98	0.89	1.43	1.11	1.33	1.31	2.33	1.36	1.10	2.84	0 of 41
TETRACHLOROETHENE	4.87	7.02	8.55	8.41	15.19	5.99	9.68	7.36	5.20	13.59	15.85	16.59	9.81	37.92	37 of 41
TOLUENE	13.92	8.71	6.92	4.69	7.77	2.16	3.98	4.31	1.33	1.31	6.84	3.22	6.04	25.46	24 of 41
TRANS-1,2-DICHLOROETHENE	0.79	0.66	0.76	0.72	0.98	0.89	1.43	1.11	1.33	1.31	2.33	1.36	1.10	2.84	0 of 41
TRANS-1,3-DICHLOROPROPENE	0.79	0.66	0.76	0.72	0.98	0.89	1.43	1.11	1.33	1.31	2.33	1.36	1.10	2.84	0 of 41
TRICHLOROETHENE	2.57	2.62	2.28	0.72	3.03	0.89	1.43	3.04	7.39	1.31	2.33	1.36	2.46	19.37	16 of 41
TRICHLOROFUOROMETHANE	0.79	0.66	0.76	0.72	0.98	0.89	1.43	1.11	1.33	1.31	2.33	1.36	1.10	2.84	0 of 41
VINYL ACETATE	0.79	0.66	0.76	0.72	0.98	0.89	1.43	1.11	1.33	1.31	2.33	1.36	1.10	2.84	0 of 41
VINYL CHLORIDE	0.79	0.66	0.76	0.72	0.98	0.89	1.43	1.11	1.33	1.31	2.33	1.36	1.10	2.84	0 of 41

Appendix B

Table B-1 Nut Island Treatment Plant Operations Summary, Fiscal Year 1998

Table B-2 Nut Island Influent Characterization, Fiscal Year 1998

Table B-3 Nut Island Influent Loadings, Fiscal Year 1998

Table B-4 Nut Island Effluent Characterization, Fiscal Year 1998

Table B-5 Nut Island Effluent Loadings, Fiscal Year 1998

Table B-1 Nut Island Treatment Plant Operations Summary, Fiscal Year 1998

	JULY	AUG	SEPT	OCT	NOV	DEC	JAN	FEB	MAR	APR*	MAY*	JUN*	MIN	AVG	MAX
INFLUENT															
FLOW (mgd)															
AVERAGE	89.19	87.3	86.82	82.09	99.17	95.96	156.16	179.28	197.6	136.62	178.11	173.81		130.18	
MINIMUM	60	65	58	35	53	51	85	117.29	125	91	80	78	35		
MAXIMUM	120	132	128	125	210	155	270	270	270	198	300	280			300
TEMP (deg F)															
AVERAGE	57	61	64	63	61	56	52	50	52	54	57	61	48	57	69
CONVENTIONAL PARAMETERS (mg/L)															
SETTLABLE SOLIDS															
AVERAGE (mL/L)	8.1	7.8	8	7.8	6.4	5.9	4.9	4.4	4.2	5	4.1	4.4		5.92	
MINIMUM (mL/L)	5.5	5.5	6	3.5	4	2.5	2.5	2	2.5	3.5	1	1.5	1		
MAXIMUM (mL/L)	29	10	11	9.5	19	7.5	7.5	7.5	6	7	6.5	11			29
TSS															
AVERAGE	167	166	172	160	134	147	99	81	86	115	101	120		129.00	
MINIMUM	110	96	82	56	56	82	13	32	38	80	24	27	13		
MAXIMUM	280	306	300	348	272	312	242	194	222	278	268	307			348
BOD															
AVERAGE	169	163	173	196	140	139	85	70	65	92	77	84		121.08	
MINIMUM	123	101	109	123	92	89	28	44	39	71	20	29	20		
MAXIMUM	288	252	216	357	225	252	195	98	100	127	146	187			357
OIL & GREASE															
AVERAGE	37.53	35.4	40.62	61.23	37.6	38.48	14.91	23.3	17.35	22.6	30.17	13.3		31.04	
CHLORIDE															
AVERAGE	588	651	676	829	416	375	369	330	266	322	307	279		450.67	
MINIMUM	113	107	126	109	120	135	166	231	163	44	163	174	44		
MAXIMUM	1270	1950	1500	1920	862	558	575	631	435	459	550	450			1950
T COLIFORM (col/100mL)															
GEO MEAN (E+06)	66	51.38	70.17	58.1	39.66	34.09	3.5	4	1.84	18.37	13.93	5.09		17.10	
MINIMUM (E+06)	22	1	44	25	20	11	0.1	1	0.1	1	2	0.1	0.1		
MAXIMUM (E+06)	140	158	112	148	95	57	20	15	8	67	78	80			158

Table B-1 Nut Island Treatment Plant Operations Summary, Fiscal Year 1998, cont.

	JULY	AUG	SEPT	OCT	NOV	DEC	JAN	FEB	MAR	APR*	MAY*	JUN*	MIN	AVG	MAX
INFLUENT															
F COLIFORM															
GEO MEAN (E+06)	5.81	4.916	5.93	6.2	2.77	1.8	0.26	0.27	0.184	1.098	1.007	0.316		1.30	
MINIMUM (E+06)	2.2	0.1	3.5	3.4	1.3	0.6	0.01	0.01	0.01	0.1	0.18	0.01	0.01		
MAXIMUM (E+06)	14.1	16.4	8.7	12.9	6.9	3.9	1.3	6	1.1	7.6	8.2	5.5			16.4
NUTRIENTS (mg/L)															
AMMONIA															
AVERAGE	23.2	32.6	31.4	29	22.5	19.6	10.4	10.4	6.09	12.9	8.69	ND	6.09	18.80	32.6
NITRITES															
AVERAGE	< 0.01	0.0205	< 0.01	< 0.01	< 0.01	< 0.01	0.0343	0.0273	0.161	< 0.01	< 0.01	ND	< 0.01	0.03	0.161
NITRATES															
AVERAGE	< 0.01	< 0.01	< 0.01	< 0.01	< 0.01	< 0.01	0.0393	< 0.01	0.927	<0.0075	< 0.01	ND	<0.0075	0.10	0.927
ORTHOPHOSPHATE															
AVERAGE	2.64	2.59	2.74	3.08	2.56	1.86	1.06	1.12	0.633	1.215	0.97	ND	0.633	1.86	3.08
TKN															
AVERAGE	35.6	46.1	46.7	42.7	38.8	29.4	19.2	23.4	9.41	22.4	16.9	ND	9.41	30.06	46.7
TOTAL PHOSPHORUS															
AVERAGE	4.71	5.93	6.52	5.97	5.3	4.02	1.86	3.19	1.66	3.85	3.31	ND	1.66	4.21	6.52
TPH (IR)															
AVERAGE	3.28	2.98	6.30	6.48	8.57	2.61	1.89	3.92	1.66	2.01	7.15	3.02	1.66	4.16	8.57

Table B-1 Nut Island Treatment Plant Operations Summary, Fiscal Year 1998, cont.

	JULY	AUG	SEPT	OCT	NOV	DEC	JAN	FEB	MAR	APR*	MAY*	JUN*	MIN	AVG	MAX
EFFLUENT															
pH (units)															
MINIMUM	6.5	6.6	6.5	6.6	6.4	6.4	6.4	6.5	6.5	6.6	6.5	6.4	6.4		
MAXIMUM	7.6	6.8	6.9	6.8	6.8	6.9	6.9	6.7	6.9	7	7.3	7			7.6
CONVENTIONAL PARAMETERS (mg/L)															
SETTLABLE SOLIDS															
AVERAGE (mL/L)	0.7	0.6	0.5	0.6	0.7	0.4	0.6	0.9	0.6	1	0.9	0.8		0.69	
MINIMUM (mL/L)	0.2	0.3	0.1	0.3	0.3	0.1	0.3	0.3	0.1	0.2	0.4	0.1	0.1		
MAXIMUM (mL/L)	2	1.5	1	1.2	1.5	1.5	1	2.5	1	7	3	2			7
TSS															
AVERAGE	70	68	72	77	71	74	47	44	34	45	37	40		56.58	
MINIMUM	34	50	36	56	26	38	22	16	17	17	9	10	9		
MAXIMUM	88	86	188	124	124	137	118	94	62	118	68	100			188
BOD															
AVERAGE	113	110	114	119	102	98	54	46	35	53	42	42		77.33	
MINIMUM	77	72	50	23	60	61	30	25	19	25	12	14	12		
MAXIMUM	134	149	200	141	158	129	143	80	59	131	80	96			200
OIL & GREASE															
AVERAGE	29.48	32.6	29	34.23	24.2	24.54	16.08	35.98	22.2	17.48	18.4	15.16		24.95	
CHLORINE RESIDUAL															
AVERAGE	4.07	4.17	3.68	4.11	4.03	3.55	3.18	3.3	3.29	2.79	3.41	1.6		3.43	
MINIMUM	2.17	2.37	1.33	2.27	1.73	2.13	1.77	2.07	1.87	2.1	2.6	0.77	0.77		
MAXIMUM	6.51	7.4	5.73	7.17	6.23	5.6	5.97	4.37	4.37	3.77	4.57	2			7.4
T COLIFORM (col/100mL)															
GEO MEAN	109	54	90	45	71	159	161	179	113	71	104	1270		119.19	
MINIMUM	20	13	20	16	13	20	16	25	34	20	20	902	13		
MAXIMUM	1348	986	5323	3092	24250	5026	1748	1289	1649	491	421	2048			24250
F COLIFORM															
GEO MEAN	12	6	7	7	8	7	11	12	11	7	11	87		10.56	
MINIMUM	4	4	5	4	4	4	4	5	5	5	5	34	4		
MAXIMUM	592	29	41	54	448	67	155	114	183	14	41	342			592

Table B-1 Nut Island Treatment Plant Operations Summary, Fiscal Year 1998, cont.

	JULY	AUG	SEPT	OCT	NOV	DEC	JAN	FEB	MAR	APR*	MAY*	JUN*	MIN	AVG	MAX
EFFLUENT															
NUTRIENTS (mg/L)															
AMMONIA															
AVERAGE	18.8	29.2	33.6	21.6	23	18.5	17.4	13.3	5.58	12.65	9.19	ND	5.58	18.44	33.6
NITRITES															
AVERAGE	< 0.01	< 0.01	< 0.01	< 0.01	< 0.01	< 0.01	< 0.01	0.0282	0.107	0.071	< 0.01	ND	< 0.01	0.03	0.107
NITRATES															
AVERAGE	< 0.01	< 0.01	< 0.01	< 0.01	0.0148	< 0.01	< 0.01	0.013	0.527	0.1555	< 0.01	ND	< 0.01	0.07	0.527
ORTHOPHOSPHATE															
AVERAGE	2.21	2.81	2.47	2.83	2.33	1.8	1.76	1.28	0.511	1.335	0.978	ND	0.511	1.85	2.83
TKN															
AVERAGE	28.6	40	39.5	35.9	27.7	28.9	23.6	20.5	6	16.75	15.2	ND	6	25.70	40
TOTAL PHOSPHORUS															
AVERAGE	3.91	5.09	5.13	4.9	4.14	3.19	2.94	2.86	1.24	2.845	2.68	ND	1.24	3.54	5.13
TPH (IR)															
AVERAGE	3.39	3.65	6.99	6.28	4.00	2.78	2.39	20.37	1.92	1.79	6.73	2.03	1.79	5.19	20.37

Notes:

* Data from April through June is a result of a reduced flow.

ND = No Data

Concentration expressed in mg/L unless otherwise noted.

Yearly averages in this table are computed from the monthly averages.

The coliform number for a given day is the geometric mean of the three grab samples taken on that day.

Table B-2 Nut Island Influent Characterization, Fiscal Year 1998

Metals (ug/L)													Average Maximum		Times
	Jul	Aug	Sep	Oct	Nov	Dec	Jan	Feb	Mar	Apr	May	Jun	Average	Maximum	Detected
ANTIMONY	17.78	20.00	20.00	20.00	20.00	20.00	20.00	20.00	20.00	20.00	20.00	20.00	19.87	20.00	0 of 87
ARSENIC	1.10	1.10	1.10	1.10	1.10	0.40	0.40	0.40	0.47	0.40	0.64	0.40	0.63	1.13	3 of 87
BERYLLIUM	0.50	0.50	0.50	0.50	0.50	0.50	0.50	0.50	0.50	0.50	0.50	0.50	0.50	0.50	0 of 86
BORON	302.40	346.15	394.22	391.03	229.47	230.44	152.76	125.00	125.00	125.00	125.00	125.00	195.25	487.00	39 of 87
CADMIUM	1.00	1.00	1.28	1.00	1.00	1.00	1.00	1.14	1.21	1.00	1.00	1.00	1.06	2.29	4 of 87
CHROMIUM	4.78	5.18	5.07	6.93	2.12	4.86	1.94	2.88	2.67	3.35	2.83	2.08	3.42	17.40	47 of 88
COPPER	94.46	83.27	113.84	110.06	87.69	98.01	57.92	63.82	52.54	60.34	61.21	63.82	73.18	194.00	88 of 88
HEXAVALENT CHROMIUM	5.50	5.50	5.50	5.50	5.50	5.50	5.50	5.50	5.50	5.50	5.50	5.50	5.50	5.50	0 of 35
IRON	2048.31	1411.98	2409.23	1889.85	1714.81	1744.73	1128.58	1164.91	964.34	1159.77	1308.94	1413.76	1425.38	3820.00	87 of 87
LEAD	9.21	8.82	13.50	12.82	12.41	9.64	5.11	5.86	5.34	5.50	9.16	10.88	8.37	31.40	86 of 87
MERCURY	0.23	0.29	0.41	0.32	0.27	0.26	0.10	0.13	0.13	0.22	0.11	0.24	0.20	0.75	74 of 87
MOLYBDENUM	6.33	5.93	4.61	7.46	4.91	3.06	3.20	2.50	2.50	4.75	2.50	2.75	3.77	13.40	29 of 88
NICKEL	4.60	5.15	4.75	5.73	4.00	4.60	4.00	4.00	4.43	4.00	4.00	4.00	4.35	12.10	8 of 87
SELENIUM	1.10	1.10	1.10	1.10	0.95	0.45	0.45	0.54	0.57	0.64	0.49	0.45	0.67	1.80	1 of 87
SILVER	2.96	2.86	4.29	5.26	3.44	4.52	2.02	1.39	1.42	1.47	2.12	2.79	2.56	9.62	71 of 87
THALLIUM	1.10	1.10	1.10	1.10	0.96	0.50	0.50	0.50	0.50	0.50	0.50	0.57	0.67	1.10	1 of 87
ZINC	110.43	108.73	136.18	141.08	100.90	118.60	66.07	62.25	56.03	59.96	67.58	68.85	83.23	220.00	88 of 88

Cyanide and Phenols (ug/L)													Average Maximum		Times
	Jul	Aug	Sep	Oct	Nov	Dec	Jan	Feb	Mar	Apr	May	Jun	Average	Maximum	Detected
CYANIDE	5.00	5.00	5.00	5.00	5.00	5.00	5.00	5.00	5.00	5.00	5.00	5.00	5.00	5.00	0 of 35
TOTAL PHENOLS	56.54	49.14	56.62	78.61	56.49	50.75	5.45	1.00	8.41	1.00	4.97	21.43	24.96	105.00	24 of 35

Oil and Grease, Petroleum Hydrocarbons, and Surfactants (mg/L)													Average Maximum		Times
	Jul	Aug	Sep	Oct	Nov	Dec	Jan	Feb	Mar	Apr	May	Jun	Average	Maximum	Detected
PETROLEUM HYDROCARBON	1.48	1.52	3.29	1.39	1.65	1.17	0.75	0.67	0.45	1.00	0.56	1.11	1.09	5.00	34 of 34
TOTAL PETROLEUM HYDROCARBON	3.27	2.94	6.24	6.47	8.37	2.64	1.82	3.87	1.20	2.00	7.25	3.02	3.58	9.84	33 of 34
FATS OIL AND GREASE	247.33	32.24	41.43	47.09	40.25	34.84	16.66	18.60	17.54	22.86	21.58	15.64	44.99	1290.00	80 of 82
MBAS	6.67	7.21	7.24	6.59	5.69	5.09	3.52	3.50	3.24	3.91	2.98	4.83	4.59	8.15	35 of 35

Table B-2 Nut Island Influent Characterization, Fiscal Year 1998, cont.

Organochlorine Pesticides and PCBs (ug/L)	Organochlorine Pesticides and PCBs (ug/L)												Times		
	Jul	Aug	Sep	Oct	Nov	Dec	Jan	Feb	Mar	Apr	May	Jun	Average	Maximum	Detected
4,4'-DDD	0.002	0.002	0.002	0.002	0.002	0.002	0.002	0.002	0.002	0.002	0.002	0.002	0.002	0.002	0 of 35
4,4'-DDE	0.002	0.002	0.002	0.002	0.002	0.002	0.002	0.002	0.002	0.002	0.002	0.002	0.002	0.002	0 of 35
4,4'-DDT	0.002	0.002	0.005	0.002	0.002	0.002	0.002	0.002	0.002	0.002	0.002	0.002	0.002	0.012	1 of 35
ALDRIN	0.002	0.002	0.002	0.002	0.002	0.002	0.002	0.002	0.002	0.002	0.002	0.002	0.002	0.002	0 of 35
ALPHA-BHC	0.002	0.002	0.002	0.002	0.002	0.002	0.002	0.002	0.002	0.002	0.002	0.002	0.002	0.002	0 of 35
ALPHA-CHLORDANE	0.002	0.002	0.002	0.002	0.002	0.002	0.002	0.005	0.002	0.002	0.005	0.002	0.003	0.013	2 of 35
AROCLOR-1016	0.052	0.052	0.053	0.052	0.054	0.054	0.055	0.055	0.052	0.052	0.054	0.053	0.053	0.058	0 of 35
AROCLOR-1221	0.104	0.105	0.105	0.103	0.108	0.107	0.110	0.111	0.104	0.105	0.109	0.105	0.106	0.116	0 of 35
AROCLOR-1232	0.052	0.052	0.053	0.052	0.054	0.054	0.055	0.055	0.052	0.052	0.054	0.053	0.053	0.058	0 of 35
AROCLOR-1242	0.052	0.052	0.053	0.052	0.054	0.054	0.055	0.055	0.052	0.052	0.054	0.053	0.053	0.058	0 of 35
AROCLOR-1248	0.052	0.052	0.053	0.052	0.054	0.054	0.055	0.055	0.052	0.052	0.054	0.053	0.053	0.058	0 of 35
AROCLOR-1254	0.052	0.052	0.053	0.052	0.054	0.054	0.055	0.055	0.052	0.052	0.054	0.053	0.053	0.058	0 of 35
AROCLOR-1260	0.052	0.052	0.053	0.052	0.054	0.054	0.055	0.055	0.052	0.052	0.054	0.053	0.053	0.058	0 of 35
BETA-BHC	0.002	0.002	0.002	0.002	0.002	0.002	0.002	0.002	0.002	0.002	0.002	0.002	0.002	0.002	0 of 35
CHLORDANE (TECHNICAL)	0.052	0.052	0.053	0.052	0.054	0.054	0.055	0.055	0.052	0.052	0.054	0.053	0.053	0.058	0 of 35
DELTA-BHC	0.002	0.002	0.002	0.002	0.002	0.002	0.002	0.002	0.002	0.002	0.002	0.002	0.002	0.002	0 of 35
DIELDRIN	0.002	0.002	0.002	0.002	0.002	0.002	0.002	0.002	0.002	0.002	0.002	0.002	0.002	0.002	0 of 35
ENDOSULFAN I	0.002	0.002	0.002	0.002	0.002	0.002	0.002	0.002	0.002	0.002	0.002	0.002	0.002	0.002	0 of 35
ENDOSULFAN II	0.002	0.002	0.002	0.002	0.002	0.002	0.002	0.002	0.002	0.002	0.002	0.002	0.002	0.002	0 of 35
ENDOSULFAN SULFATE	0.002	0.002	0.002	0.002	0.002	0.002	0.002	0.002	0.002	0.002	0.002	0.002	0.002	0.002	0 of 35
ENDRIN	0.002	0.002	0.002	0.002	0.002	0.002	0.002	0.002	0.002	0.002	0.002	0.002	0.002	0.002	0 of 35
ENDRIN ALDEHYDE	0.002	0.002	0.002	0.002	0.002	0.002	0.002	0.002	0.002	0.002	0.002	0.002	0.002	0.002	0 of 35
ENDRIN KETONE	0.002	0.002	0.002	0.002	0.002	0.002	0.002	0.002	0.002	0.002	0.002	0.002	0.002	0.002	0 of 35
GAMMA-BHC (LINDANE)	0.002	0.002	0.002	0.008	0.002	0.006	0.002	0.002	0.002	0.002	0.002	0.005	0.003	0.020	3 of 35
GAMMA-CHLORDANE	0.002	0.002	0.002	0.002	0.002	0.002	0.002	0.005	0.002	0.002	0.005	0.002	0.003	0.012	2 of 35
HEPTACHLOR	0.002	0.002	0.002	0.002	0.002	0.002	0.002	0.002	0.002	0.002	0.002	0.002	0.002	0.002	0 of 35
HEPTACHLOR EPOXIDE	0.002	0.002	0.002	0.002	0.002	0.002	0.002	0.002	0.002	0.002	0.002	0.002	0.002	0.002	0 of 35
METHOXYCHLOR	0.021	0.015	0.021	0.021	0.022	0.021	0.022	0.091	0.021	0.021	0.022	0.021	0.028	0.220	1 of 35
TOXAPHENE	0.052	0.052	0.053	0.052	0.054	0.054	0.055	0.055	0.052	0.052	0.054	0.053	0.053	0.058	0 of 35

Table B-2 Nut Island Influent Characterization, Fiscal Year 1998, cont.

Semivolatile Organics (ug/L)													Average	Maximum	Times Detected
	Jul	Aug	Sep	Oct	Nov	Dec	Jan	Feb	Mar	Apr	May	Jun			
1,2,4-TRICHLOROBENZENE	1.00	1.07	1.73	1.03	1.12	1.41	1.04	1.06	1.05	1.09	1.11	1.05	1.13	2.06	0 of 35
1,2-DICHLOROBENZENE	1.00	1.07	1.73	1.03	1.12	1.41	1.04	1.06	1.05	1.09	1.11	1.05	1.13	2.06	0 of 35
1,2-DIPHENYLHYDRAZINE (AS AZOB)	1.00	1.07	1.73	1.03	1.12	1.41	1.04	1.06	1.05	1.09	1.11	1.05	1.13	2.06	0 of 35
1,3-DICHLOROBENZENE	1.00	1.07	1.73	1.03	1.12	1.41	1.04	1.06	1.05	1.09	1.11	1.05	1.13	2.06	0 of 35
1,4-DICHLOROBENZENE	1.00	1.07	1.73	1.03	1.12	1.41	1.04	1.06	1.05	1.09	1.11	1.05	1.13	2.06	0 of 35
2,2'-OXYBIS(1-CHLOROPROPANE)	1.00	1.07	1.73	1.03	1.12	1.41	1.04	1.06	1.05	1.09	1.11	1.05	1.13	2.06	0 of 35
2,4,5-TRICHLOROPHENOL	1.00	1.07	1.73	1.03	1.12	1.41	1.04	1.06	1.05	1.09	1.11	1.05	1.13	2.06	0 of 35
2,4,6-TRICHLOROPHENOL	1.00	1.07	1.73	1.03	1.12	1.41	1.04	1.06	1.05	1.09	1.11	1.05	1.13	2.06	0 of 35
2,4-DICHLOROPHENOL	1.00	1.07	1.73	1.03	1.12	1.41	1.04	1.06	1.05	1.09	1.11	1.05	1.13	2.06	0 of 35
2,4-DIMETHYLPHENOL	1.00	1.07	1.73	1.03	1.12	1.41	1.04	1.06	1.05	1.09	1.11	1.05	1.13	2.06	0 of 35
2,4-DINITROPHENOL	2.00	2.14	3.46	2.07	2.25	2.83	2.09	2.12	2.11	2.17	2.23	2.11	2.26	4.12	0 of 35
2,4-DINITROTOLUENE	1.00	1.07	1.73	1.03	1.12	1.41	1.04	1.06	1.05	1.09	1.11	1.05	1.13	2.06	0 of 35
2,6-DINITROTOLUENE	1.00	1.07	1.73	1.03	1.12	1.41	1.04	1.06	1.05	1.09	1.11	1.05	1.13	2.06	0 of 35
2-CHLORONAPHTHALENE	1.00	1.07	1.73	1.03	1.12	1.41	1.04	1.06	1.05	1.09	1.11	1.05	1.13	2.06	0 of 35
2-CHLOROPHENOL	1.00	1.07	1.73	1.03	1.12	1.41	1.04	1.06	1.05	1.09	1.11	1.05	1.13	2.06	0 of 35
2-METHYL-4,6-DINITROPHENOL	10.00	10.71	17.30	10.34	11.25	14.14	10.43	10.61	10.54	10.86	11.14	10.53	11.31	20.60	0 of 35
2-METHYLNAPHTHALENE	1.00	1.07	1.73	1.03	1.12	1.41	1.04	1.06	1.05	1.09	1.11	1.05	1.13	2.06	0 of 35
2-METHYLPHENOL	1.00	1.07	1.73	1.03	1.12	1.41	1.04	1.06	1.05	1.09	1.11	1.05	1.13	2.06	0 of 35
2-NITROANILINE	1.00	1.07	1.73	1.03	1.12	1.41	1.04	1.06	1.05	1.09	1.11	1.05	1.13	2.06	0 of 35
2-NITROPHENOL	1.00	1.07	1.73	1.03	1.12	1.41	1.04	1.06	1.05	1.09	1.11	1.05	1.13	2.06	0 of 35
3,3'-DICHLOROBENZIDINE	2.00	2.14	3.46	2.07	2.25	2.83	2.09	2.12	2.11	2.17	2.23	2.11	2.26	4.12	0 of 35
3-NITROANILINE	1.00	1.07	1.73	1.03	1.12	1.41	1.04	1.06	1.05	1.09	1.11	1.05	1.13	2.06	0 of 35
4-BROMOPHENYL PHENYL ETHER	1.00	1.07	1.73	1.03	1.12	1.41	1.04	1.06	1.05	1.09	1.11	1.05	1.13	2.06	0 of 35
4-CHLORO-3-METHYLPHENOL	1.00	1.07	1.73	1.03	1.12	1.41	1.04	1.06	1.05	1.09	1.11	1.05	1.13	2.06	0 of 35
4-CHLOROANILINE	1.00	1.07	1.73	1.03	1.12	1.41	1.04	1.06	1.05	1.09	1.11	1.05	1.13	2.06	0 of 35
4-CHLOROPHENYL PHENYL ETHER	1.00	1.07	1.73	1.03	1.12	1.41	1.04	1.06	1.05	1.09	1.11	1.05	1.13	2.06	0 of 35
4-METHYLPHENOL (INCLUDES 3-MET)	31.47	31.51	37.02	41.16	29.39	18.21	5.44	8.81	1.05	10.27	10.06	21.12	16.42	57.10	29 of 35
4-NITROANILINE	1.00	1.07	1.73	1.03	1.12	1.41	1.04	1.06	1.05	1.09	1.11	1.05	1.13	2.06	0 of 35
4-NITROPHENOL	2.00	2.14	3.46	2.07	2.25	2.83	2.09	2.12	2.11	2.17	2.23	2.11	2.26	4.12	0 of 35
ACENAPHTHENE	1.00	1.07	1.73	1.03	1.12	1.41	1.04	1.06	1.05	1.09	1.11	1.05	1.13	2.06	0 of 35
ACENAPHTHYLENE	1.00	1.07	1.73	1.03	1.12	1.41	1.04	1.06	1.05	1.09	1.11	1.05	1.13	2.06	0 of 35
ANILINE	1.00	1.07	1.73	1.03	1.12	1.41	1.04	1.06	1.05	1.09	1.11	1.05	1.13	2.06	0 of 35
ANTHRACENE	1.00	1.07	1.73	1.03	1.12	1.41	1.04	1.06	1.05	1.09	1.11	1.05	1.13	2.06	0 of 35
BENZIDINE	5.01	5.35	8.65	5.17	17.91	7.07	5.22	5.30	5.27	5.43	5.57	5.27	6.04	31.10	2 of 35
BENZO(A)ANTHRACENE	1.00	1.07	1.73	1.03	1.12	1.41	1.04	1.06	1.05	1.09	1.11	1.05	1.13	2.06	0 of 35
BENZO(A)PYRENE	1.00	1.07	1.73	1.03	1.12	1.41	1.04	1.06	1.05	1.09	1.11	1.05	1.13	2.06	0 of 35
BENZO(B)FLUORANTHENE	1.00	1.07	1.73	1.03	1.12	1.41	1.04	1.06	1.05	1.09	1.11	1.05	1.13	2.06	0 of 35
BENZO(GHI)PERYLENE	1.00	1.07	1.73	1.03	1.12	1.41	1.04	1.06	1.05	1.09	1.11	1.05	1.13	2.06	0 of 35
BENZO(K)FLUORANTHENE	1.00	1.07	1.73	1.03	1.12	1.41	1.04	1.06	1.05	1.09	1.11	1.05	1.13	2.06	0 of 35
BENZOIC ACID	31.49	24.62	47.35	18.50	25.95	22.44	8.38	23.04	2.11	5.94	5.89	24.67	16.71	86.40	20 of 35

Table B-2 Nut Island Influent Characterization, Fiscal Year 1998, cont.

Semivolatile Organics (ug/L)													Times		
	Jul	Aug	Sep	Oct	Nov	Dec	Jan	Feb	Mar	Apr	May	Jun	Average	Maximum	Detected
BENZYL ALCOHOL	10.03	10.07	8.60	20.74	12.89	19.89	7.54	4.27	1.05	3.02	1.11	6.92	7.29	33.50	23 of 35
BIS(2-CHLOROETHOXY)METHANE	1.00	1.07	1.73	1.03	1.12	1.41	1.04	1.06	1.05	1.09	1.11	1.05	1.13	2.06	0 of 35
BIS(2-CHLOROETHYL)ETHER	1.00	1.07	1.73	1.03	1.12	1.41	1.04	1.06	1.05	1.09	1.11	1.05	1.13	2.06	0 of 35
BIS(2-ETHYLHEXYL)PHTHALATE	5.85	8.16	6.12	7.51	4.88	1.41	1.04	1.06	1.05	1.09	3.29	1.05	2.95	9.67	12 of 35
BUTYL BENZYL PHTHALATE	1.00	1.07	1.73	1.17	1.12	1.41	1.04	1.06	1.05	1.09	1.11	1.05	1.14	2.06	1 of 35
CHRYSENE	1.00	1.07	1.73	1.03	1.12	1.41	1.04	1.06	1.05	1.09	1.11	1.05	1.13	2.06	0 of 35
DIBENZO(A,H)ANTHRACENE	1.00	1.07	1.73	1.03	1.12	1.41	1.04	1.06	1.05	1.09	1.11	1.05	1.13	2.06	0 of 35
DIBENZOFURAN	1.00	1.07	1.73	1.03	1.12	1.41	1.04	1.06	1.05	1.09	1.11	1.05	1.13	2.06	0 of 35
DIETHYL PHTHALATE	4.25	2.57	3.72	7.42	6.56	2.94	1.06	1.05	1.09	1.11	4.28	2.59	8.45	13 of 35	
DIMETHYL PHTHALATE	1.00	1.07	1.73	1.03	1.12	1.41	1.04	1.06	1.05	1.09	1.11	1.05	1.13	2.06	0 of 35
DI-N-BUTYLPHTHALATE	1.00	1.07	1.73	1.29	1.12	1.41	1.04	1.06	1.05	1.09	1.11	1.05	1.15	2.06	1 of 35
DI-N-OCTYLPHTHALATE	1.00	1.07	1.73	1.03	1.12	1.41	1.04	1.06	1.05	1.09	1.11	1.05	1.13	2.06	0 of 35
FLUORANTHENE	1.00	1.07	1.73	1.03	1.12	1.41	1.04	1.06	1.05	1.09	1.11	1.05	1.13	2.06	0 of 35
FLUORENE	1.00	1.07	1.73	1.03	1.12	1.41	1.04	1.06	1.05	1.09	1.11	1.05	1.13	2.06	0 of 35
HEXACHLOROBENZENE	1.00	1.07	1.73	1.03	1.12	1.41	1.04	1.06	1.05	1.09	1.11	1.05	1.13	2.06	0 of 35
HEXACHLOROBUTADIENE	1.00	1.07	1.73	1.03	1.12	1.41	1.04	1.06	1.05	1.09	1.11	1.05	1.13	2.06	0 of 35
HEXACHLOROCYCLOPENTADIENE	5.00	5.35	8.65	5.17	5.62	7.07	5.22	5.30	5.27	5.43	5.57	5.27	5.66	10.30	0 of 35
HEXACHLOROETHANE	1.00	1.07	1.73	1.03	1.12	1.41	1.04	1.06	1.05	1.09	1.11	1.05	1.13	2.06	0 of 35
INDENO(1,2,3-CD)PYRENE	1.00	1.07	1.73	1.03	1.12	1.41	1.04	1.06	1.05	1.09	1.11	1.05	1.13	2.06	0 of 35
ISOPHORONE	1.00	1.07	1.73	1.03	1.12	1.41	1.04	1.06	1.05	1.09	1.11	1.05	1.13	2.06	0 of 35
NAPHTHALENE	1.00	1.07	1.73	1.03	1.12	1.41	1.04	1.06	1.05	1.09	1.11	1.05	1.13	2.06	0 of 35
NITROBENZENE	1.00	1.07	1.73	1.03	1.12	1.41	1.04	1.06	1.05	1.09	1.11	1.05	1.13	2.06	0 of 35
N-NITROSODIMETHYLAMINE	1.00	1.07	1.73	1.03	1.12	1.41	1.04	1.06	1.05	1.09	1.11	1.05	1.13	2.06	0 of 35
N-NITROSODI-N-PROPYLAMINE	1.00	1.07	1.73	1.03	1.12	1.59	1.04	1.06	1.05	1.09	1.11	1.05	1.13	2.06	0 of 34
N-NITROSODIPHENYLAMINE	1.00	1.07	1.73	1.03	1.12	1.41	1.04	1.06	1.05	1.09	1.11	1.05	1.13	2.06	0 of 35
PENTACHLOROPHENOL	5.00	5.35	8.65	5.17	5.62	7.07	5.22	5.30	5.27	5.43	5.57	5.27	5.66	10.30	0 of 35
PHENANTHRENE	1.00	1.07	1.73	1.03	1.12	1.41	0.10	0.11	0.11	0.11	0.11	0.11	0.52	2.06	0 of 35
PHENOL	9.71	2.14	3.46	14.72	6.76	2.83	2.09	2.12	2.11	2.17	2.23	5.17	3.91	25.40	7 of 35
PYRENE	1.00	1.07	1.73	1.03	1.12	1.41	1.04	1.06	1.05	1.09	1.11	1.05	1.13	2.06	0 of 35

Table B-2 Nut Island Influent Characterization, Fiscal Year 1998, cont.

Volatile Organics (ug/L)													Times		
	Jul	Aug	Sep	Oct	Nov	Dec	Jan	Feb	Mar	Apr	May	Jun	Average	Maximum	Detected
1,1,1-TRICHLOROETHANE	0.50	0.50	0.50	0.50	0.50	0.50	0.50	0.50	0.50	0.50	0.50	0.50	0.50	0.50	0 of 35
1,1,2,2-TETRACHLOROETHANE	0.50	0.50	0.50	0.50	0.50	0.50	0.50	0.50	0.50	0.50	0.50	0.50	0.50	0.50	0 of 35
1,1,2-TRICHLOROETHANE	0.50	0.50	0.50	0.50	0.50	0.50	0.50	0.50	0.50	0.50	0.50	0.50	0.50	0.50	0 of 35
1,1-DICHLOROETHANE	0.50	0.50	0.50	0.50	0.50	0.50	0.50	0.50	0.50	0.50	0.50	0.50	0.50	0.50	0 of 35
1,1-DICHLOROETHENE	0.50	0.50	0.50	0.50	0.50	0.50	0.50	0.50	0.50	0.50	0.50	0.50	0.50	0.50	0 of 35
1,2-DICHLOROBENZENE	0.50	0.50	0.50	0.50	0.50	0.50	0.50	0.50	0.50	0.50	0.50	0.50	0.50	0.50	0 of 35
1,2-DICHLOROETHANE	0.50	0.50	0.50	0.50	0.50	0.50	0.50	0.50	0.50	0.50	0.50	0.50	0.50	0.50	0 of 35
1,2-DICHLOROPROPANE	0.50	0.50	0.50	0.50	0.50	0.50	0.50	0.50	0.50	0.50	0.50	0.50	0.50	0.50	0 of 35
1,3-DICHLOROBENZENE	0.50	0.50	0.50	0.50	2.26	0.50	0.50	0.50	0.50	0.50	0.50	0.50	0.56	4.65	1 of 35
1,4-DICHLOROBENZENE	1.98	1.78	2.94	1.99	2.07	1.27	0.50	0.50	0.50	0.50	0.50	0.50	1.05	3.74	13 of 35
2-BUTANONE	3.99	29.49	41.29	4.56	108.30	84.19	35.37	4.41	1.26	1.19	2.29	3.12	19.98	110.00	20 of 35
2-CHLOROETHYL VINYL ETHER	0.50	0.50	0.50	0.50	0.50	0.50	0.50	0.50	0.50	0.50	0.50	0.50	0.50	0.50	0 of 35
2-HEXANONE	0.50	0.50	0.50	0.50	1.95	0.50	0.50	0.50	0.50	0.50	0.50	0.50	0.55	3.92	1 of 35
4-METHYL-2-PENTANONE	0.50	0.50	0.50	0.50	0.50	0.50	0.50	0.50	0.50	0.50	1.40	0.56	3.20	1 of 35	
ACETONE	189.18	205.60	185.33	192.10	221.17	114.36	69.49	124.26	106.13	155.05	69.53	120.22	131.98	285.00	35 of 35
ACROLEIN	0.50	0.50	0.50	0.50	0.50	0.50	0.50	0.50	0.50	0.50	0.50	0.50	0.50	0.50	0 of 35
ACRYLONITRILE	0.50	0.50	0.50	0.50	0.50	0.50	0.50	0.50	0.50	0.50	0.50	0.50	0.50	0.50	0 of 35
BENZENE	0.50	0.50	0.50	0.50	0.50	0.50	0.50	0.50	0.50	0.50	0.50	0.50	0.50	0.50	0 of 35
BROMODICHLOROMETHANE	0.50	0.50	0.50	0.50	0.50	0.50	0.50	0.50	0.50	0.50	0.50	0.50	0.50	0.50	0 of 35
BROMOFORM	0.50	0.50	0.50	0.50	0.50	0.50	0.50	0.50	0.50	0.50	0.50	0.50	0.50	0.50	0 of 35
BROMOMETHANE	0.50	0.50	0.50	0.50	0.50	0.50	0.50	0.50	0.50	0.50	0.50	0.50	0.50	0.50	0 of 35
CARBON DISULFIDE	0.96	1.43	0.76	0.93	0.50	1.50	0.50	2.28	0.50	0.50	0.50	0.50	0.89	5.73	10 of 35
CARBON TETRACHLORIDE	0.50	0.50	0.50	0.50	0.50	0.50	0.50	0.50	0.50	0.50	0.50	0.50	0.50	0.50	0 of 35
CHLOROBENZENE	0.50	0.50	0.50	0.50	0.50	0.50	0.50	0.50	0.50	0.50	0.50	0.50	0.50	0.50	0 of 35
CHLOROETHANE	0.50	0.50	0.50	0.50	0.50	0.50	0.50	0.50	0.50	0.50	0.50	0.50	0.50	0.50	0 of 35
CHLOROFORM	4.95	5.23	5.20	4.25	4.32	3.66	2.18	3.50	2.87	4.27	4.66	5.33	3.99	6.12	34 of 35
CHLOROMETHANE	0.50	0.50	0.50	0.50	2.76	0.50	0.50	0.50	0.50	0.50	0.50	0.50	0.58	4.43	1 of 35
CIS-1,2-DICHLOROETHENE	0.50	0.50	0.50	0.50	0.50	0.50	0.50	0.50	0.50	0.50	0.50	0.50	0.50	0.50	0 of 35
CIS-1,3-DICHLOROPROPENE	0.50	0.50	0.50	0.50	0.50	0.50	0.50	0.50	0.50	0.50	0.50	0.50	0.50	0.50	0 of 35
DIBROMOCHLOROMETHANE	0.50	0.50	0.50	0.50	0.50	0.50	0.50	0.50	0.50	0.50	0.50	0.50	0.50	0.50	0 of 35
ETHYLBENZENE	0.50	0.50	0.50	0.50	0.50	0.50	0.50	0.50	0.50	0.50	0.50	0.50	0.50	0.50	0 of 35
M,P-XYLENE	0.69	0.50	0.78	0.67	2.40	1.44	0.50	0.50	0.50	0.50	0.50	0.50	0.67	4.98	5 of 35
METHYLENE CHLORIDE	1.43	3.67	4.91	4.92	1.79	2.22	0.50	1.29	2.43	2.42	1.55	9.39	2.74	24.40	22 of 35
O-XYLENE	0.50	0.50	0.50	0.50	0.50	0.50	0.50	0.50	0.50	0.50	0.50	0.50	0.50	0.50	0 of 35

Table B-2 Nut Island Influent Characterization, Fiscal Year 1998, cont.

Volatile Organics (ug/L)													Times		
	Jul	Aug	Sep	Oct	Nov	Dec	Jan	Feb	Mar	Apr	May	Jun	Average	Maximum	Detected
STYRENE	0.50	0.50	0.50	0.50	0.50	0.50	0.50	0.50	0.50	0.50	0.50	6.81	0.91	20.20	1 of 35
TETRACHLOROETHENE	2.60	2.48	2.77	4.47	11.84	4.63	4.64	7.18	4.30	6.40	6.94	5.94	5.19	17.40	35 of 35
TOLUENE	5.53	7.62	6.43	4.84	6.05	2.65	1.98	1.79	1.05	1.29	0.50	4.58	3.01	10.00	24 of 35
TRANS-1,2-DICHLOROETHENE	0.50	0.50	0.50	0.50	0.50	0.50	0.50	0.50	0.50	0.50	0.50	0.50	0.50	0.50	0 of 35
TRANS-1,3-DICHLOROPROPENE	0.50	0.50	0.50	0.50	0.50	0.50	0.50	0.50	0.50	0.50	0.50	0.50	0.50	0.50	0 of 35
TRICHLOROETHENE	0.50	0.50	0.50	0.50	0.50	0.50	0.50	0.50	0.50	0.50	0.50	0.50	0.50	0.50	0 of 35
TRICHLOROFLUOROMETHANE	0.50	0.50	0.50	0.50	0.50	0.50	0.50	0.50	0.50	0.50	0.50	0.50	0.50	0.50	0 of 35
VINYL ACETATE	0.50	0.50	0.50	0.50	0.50	0.50	0.50	0.50	0.50	0.50	0.50	0.50	0.50	0.50	0 of 35
VINYL CHLORIDE	0.50	0.50	0.50	0.50	0.50	0.50	0.50	0.50	0.50	0.50	0.50	0.50	0.50	0.50	0 of 35

Notes:

Results in **bold italics** indicate one or more detects in the month.

Yearly averages are calculated from individual results collected in the fiscal year.

Non-detected compounds are assumed to equal one half of the detection limit for metals and inorganics and one tenth of the reporting limit for organic compounds.

Table B-3 Nut Island Influent Loadings, Fiscal Year 1998

Metals (lbs/day)															Times Detected
	Jul	Aug	Sep	Oct	Nov	Dec	Jan	Feb	Mar	Apr	May	Jun	Average	Maximum	
ANTIMONY	13.34	14.35	14.40	14.14	13.46	16.36	25.88	23.48	33.82	22.10	29.56	25.24	20.63	50.07	0 of #
ARSENIC	0.83	0.79	0.79	0.78	0.74	0.33	0.52	0.47	0.80	0.44	0.94	0.50	0.66	1.86	3 of #
BERYLLIUM	0.38	0.36	0.36	0.35	0.34	0.41	0.65	0.59	0.85	0.55	0.74	0.63	0.52	1.25	0 of #
BORON	226.92	248.37	283.88	276.37	154.47	188.50	197.65	146.76	211.39	138.14	184.72	157.74	202.73	328.79	# of #
CADMIUM	0.75	0.72	0.92	0.71	0.67	0.82	1.29	1.33	2.04	1.11	1.48	1.26	1.10	4.95	4 of #
CHROMIUM	3.59	3.71	3.65	4.90	1.43	3.98	2.50	3.38	4.51	3.70	4.18	2.62	3.56	14.92	# of #
COPPER	70.88	59.75	81.98	77.79	59.03	80.17	74.94	74.92	88.86	66.68	90.45	80.54	75.98	289.99	# of #
HEXAVALENT CHROMIUM	4.45	3.82	4.13	3.85	3.12	4.55	6.95	6.29	9.23	5.74	7.30	4.10	5.36	11.47	0 of #
IRON	1537.07	1013.12	1734.87	1335.72	1154.35	1427.23	1460.22	1367.65	1630.84	1281.72	1934.30	1784.10	1479.97	6330.49	# of #
LEAD	6.91	6.33	9.72	9.06	8.35	7.89	6.61	6.88	9.03	6.08	13.54	13.73	8.69	59.51	# of #
MERCURY	0.17	0.21	0.30	0.23	0.18	0.21	0.12	0.16	0.22	0.25	0.17	0.30	0.21	1.03	# of #
MOLYBDENUM	4.75	4.25	3.32	5.27	3.31	2.50	4.14	2.94	4.23	5.25	3.69	3.47	3.91	9.52	# of #
NICKEL	3.46	3.69	3.42	4.05	2.69	3.76	5.18	4.70	7.50	4.42	5.91	5.05	4.52	11.41	8 of #
SELENIUM	0.83	0.79	0.79	0.78	0.64	0.37	0.58	0.64	0.97	0.71	0.73	0.57	0.70	2.19	1 of #
SILVER	2.22	2.05	3.09	3.64	2.32	3.69	2.61	1.64	2.40	1.62	3.13	3.53	2.67	11.22	# of #
THALLIUM	0.83	0.79	0.79	0.78	0.64	0.41	0.65	0.59	0.85	0.55	0.74	0.71	0.69	1.25	1 of #
ZINC	82.87	78.02	98.06	99.71	67.92	97.02	85.48	73.09	94.75	66.27	99.87	86.89	86.42	301.36	# of #
Cyanide and Phenols (lbs/day)															
	Jul	Aug	Sep	Oct	Nov	Dec	Jan	Feb	Mar	Apr	May	Jun	Average	Maximum	Times Detected
CYANIDE	4.05	3.47	3.76	3.50	2.84	4.14	6.32	5.72	8.39	5.22	6.63	3.73	4.87	10.43	0 of #
TOTAL PHENOLS	42.67	35.44	40.87	55.72	29.65	42.72	6.47	1.16	15.01	1.10	6.32	15.97	24.28	73.02	# of #
Oil and Grease, Petroleum Hydrocarbons, and Surfactants (lbs/day)															
	Jul	Aug	Sep	Oct	Nov	Dec	Jan	Feb	Mar	Apr	May	Jun	Average	Maximum	Times Detected
PETROLEUM HYDROCARBON	1198	1053	2473	974	937	971	945	764	762	1026	744	828	1061	3961	# of #
TOTAL PETROLEUM HYDROCARBON	2648	2041	4689	4531	4750	2186	2302	4431	2022	2087	10443	2251	3469	12946	# of #
FATS OIL AND GREASE	188980	22888	30417	33336	27665	28830	22101	21750	27884	24755	33856	19980	39958	994711	# of #
MBAS	5032	5200	5226	4672	2986	4284	4184	4065	5778	4307	3784	3604	4468	7283	# of #

Table B-3 Nut Island Influent Loadings, Fiscal Year 1998, cont.

Organochlorine Pesticides and PCBs (lbs/day)	Jul	Aug	Sep	Oct	Nov	Dec	Jan	Feb	Mar	Apr	May	Jun	Average	Maximum	Times Detected
4,4'-DDD	0.002	0.002	0.002	0.001	0.001	0.002	0.003	0.003	0.004	0.002	0.003	0.002	0.002	0.005	0 of #
4,4'-DDE	0.002	0.002	0.002	0.001	0.001	0.002	0.003	0.003	0.004	0.002	0.003	0.002	0.002	0.005	0 of #
4,4'-DDT	0.002	0.002	0.004	0.001	0.001	0.002	0.003	0.003	0.004	0.002	0.003	0.002	0.002	0.009	1 of #
ALDRIN	0.002	0.002	0.002	0.001	0.001	0.002	0.003	0.003	0.004	0.002	0.003	0.002	0.002	0.005	0 of #
ALPHA-BHC	0.002	0.002	0.002	0.001	0.001	0.002	0.003	0.003	0.004	0.002	0.003	0.002	0.002	0.005	0 of #
ALPHA-CHLORDANE	0.002	0.002	0.002	0.001	0.001	0.002	0.003	0.006	0.004	0.002	0.006	0.002	0.003	0.013	2 of #
AROCLOR-1016	0.039	0.038	0.038	0.037	0.028	0.045	0.065	0.064	0.092	0.058	0.069	0.039	0.052	0.113	0 of #
AROCLOR-1221	0.078	0.076	0.076	0.073	0.057	0.090	0.130	0.128	0.185	0.115	0.138	0.079	0.103	0.226	0 of #
AROCLOR-1232	0.039	0.038	0.038	0.037	0.028	0.045	0.065	0.064	0.092	0.058	0.069	0.039	0.052	0.113	0 of #
AROCLOR-1242	0.039	0.038	0.038	0.037	0.028	0.045	0.065	0.064	0.092	0.058	0.069	0.039	0.052	0.113	0 of #
AROCLOR-1248	0.039	0.038	0.038	0.037	0.028	0.045	0.065	0.064	0.092	0.058	0.069	0.039	0.052	0.113	0 of #
AROCLOR-1254	0.039	0.038	0.038	0.037	0.028	0.045	0.065	0.064	0.092	0.058	0.069	0.039	0.052	0.113	0 of #
AROCLOR-1260	0.039	0.038	0.038	0.037	0.028	0.045	0.065	0.064	0.092	0.058	0.069	0.039	0.052	0.113	0 of #
BETA-BHC	0.002	0.002	0.002	0.001	0.001	0.002	0.003	0.003	0.004	0.002	0.003	0.002	0.002	0.005	0 of #
CHLORDANE (TECHNICAL)	0.039	0.038	0.038	0.037	0.028	0.045	0.065	0.064	0.092	0.058	0.069	0.039	0.052	0.113	0 of #
DELTA-BHC	0.002	0.002	0.002	0.001	0.001	0.002	0.003	0.003	0.004	0.002	0.003	0.002	0.002	0.005	0 of #
DIELDRIN	0.002	0.002	0.002	0.001	0.001	0.002	0.003	0.003	0.004	0.002	0.003	0.002	0.002	0.005	0 of #
ENDOSULFAN I	0.002	0.002	0.002	0.001	0.001	0.002	0.003	0.003	0.004	0.002	0.003	0.002	0.002	0.005	0 of #
ENDOSULFAN II	0.002	0.002	0.002	0.001	0.001	0.002	0.003	0.003	0.004	0.002	0.003	0.002	0.002	0.005	0 of #
ENDOSULFAN SULFATE	0.002	0.002	0.002	0.001	0.001	0.002	0.003	0.003	0.004	0.002	0.003	0.002	0.002	0.005	0 of #
ENDRIN	0.002	0.002	0.002	0.001	0.001	0.002	0.003	0.003	0.004	0.002	0.003	0.002	0.002	0.005	0 of #
ENDRIN ALDEHYDE	0.002	0.002	0.002	0.001	0.001	0.002	0.003	0.003	0.004	0.002	0.003	0.002	0.002	0.005	0 of #
ENDRIN KETONE	0.002	0.002	0.002	0.001	0.001	0.002	0.003	0.003	0.004	0.002	0.003	0.002	0.002	0.005	0 of #
GAMMA-BHC (LINDANE)	0.002	0.002	0.002	0.006	0.001	0.005	0.003	0.003	0.004	0.002	0.003	0.004	0.003	0.014	3 of #
GAMMA-CHLORDANE	0.002	0.002	0.002	0.001	0.001	0.002	0.003	0.005	0.004	0.002	0.006	0.002	0.003	0.013	2 of #
HEPTACHLOR	0.002	0.002	0.002	0.001	0.001	0.002	0.003	0.003	0.004	0.002	0.003	0.002	0.002	0.005	0 of #
HEPTACHLOR EPOXIDE	0.002	0.002	0.002	0.001	0.001	0.002	0.003	0.003	0.004	0.002	0.003	0.002	0.002	0.005	0 of #
METHOXYCHLOR	0.016	0.011	0.015	0.015	0.011	0.018	0.026	0.106	0.037	0.023	0.028	0.016	0.027	0.267	1 of #
TOXAPHENE	0.039	0.038	0.038	0.037	0.028	0.045	0.065	0.064	0.092	0.058	0.069	0.039	0.052	0.113	0 of #

Table B-3 Nut Island Influent Loadings, Fiscal Year 1998, cont.

Semivolatile Organics (lbs/day)	Jul	Aug	Sep	Oct	Nov	Dec	Jan	Feb	Mar	Apr	May	Jun	Average	Maximum	Times Detected
1,2,4-TRICHLOROENZENE	0.75	0.77	1.25	0.73	0.59	1.19	1.24	1.23	1.88	1.20	1.42	0.79	1.10	2.28	0 of #
1,2-DICHLOROENZENE	0.75	0.77	1.25	0.73	0.59	1.19	1.24	1.23	1.88	1.20	1.42	0.79	1.10	2.28	0 of #
1,2-DIPHENYLHYDRAZINE (AS AZOB)	0.75	0.77	1.25	0.73	0.59	1.19	1.24	1.23	1.88	1.20	1.42	0.79	1.10	2.28	0 of #
1,3-DICHLOROENZENE	0.75	0.77	1.25	0.73	0.59	1.19	1.24	1.23	1.88	1.20	1.42	0.79	1.10	2.28	0 of #
1,4-DICHLOROENZENE	0.75	0.77	1.25	0.73	0.59	1.19	1.24	1.23	1.88	1.20	1.42	0.79	1.10	2.28	0 of #
2,2'-OXYBIS(1-CHLOROPROPANE)	0.75	0.77	1.25	0.73	0.59	1.19	1.24	1.23	1.88	1.20	1.42	0.79	1.10	2.28	0 of #
2,4,5-TRICHLOROPHENOL	0.75	0.77	1.25	0.73	0.59	1.19	1.24	1.23	1.88	1.20	1.42	0.79	1.10	2.28	0 of #
2,4,6-TRICHLOROPHENOL	0.75	0.77	1.25	0.73	0.59	1.19	1.24	1.23	1.88	1.20	1.42	0.79	1.10	2.28	0 of #
2,4-DICHLOROPHENOL	0.75	0.77	1.25	0.73	0.59	1.19	1.24	1.23	1.88	1.20	1.42	0.79	1.10	2.28	0 of #
2,4-DIMETHYLPHENOL	0.75	0.77	1.25	0.73	0.59	1.19	1.24	1.23	1.88	1.20	1.42	0.79	1.10	2.28	0 of #
2,4-DINITROPHENOL	1.51	1.54	2.50	1.47	1.18	2.38	2.48	2.46	3.76	2.39	2.83	1.57	2.20	4.56	0 of #
2,4-DINITROTOLUENE	0.75	0.77	1.25	0.73	0.59	1.19	1.24	1.23	1.88	1.20	1.42	0.79	1.10	2.28	0 of #
2,6-DINITROTOLUENE	0.75	0.77	1.25	0.73	0.59	1.19	1.24	1.23	1.88	1.20	1.42	0.79	1.10	2.28	0 of #
2-CHLORONAPHTHALENE	0.75	0.77	1.25	0.73	0.59	1.19	1.24	1.23	1.88	1.20	1.42	0.79	1.10	2.28	0 of #
2-CHLOROPHENOL	0.75	0.77	1.25	0.73	0.59	1.19	1.24	1.23	1.88	1.20	1.42	0.79	1.10	2.28	0 of #
2-METHYL-4,6-DINITROPHENOL	7.55	7.72	12.48	7.33	5.90	11.90	12.39	12.32	18.81	11.95	14.15	7.85	11.01	22.78	0 of #
2-METHYLNAPHTHALENE	0.75	0.77	1.25	0.73	0.59	1.19	1.24	1.23	1.88	1.20	1.42	0.79	1.10	2.28	0 of #
2-METHYLPHENOL	0.75	0.77	1.25	0.73	0.59	1.19	1.24	1.23	1.88	1.20	1.42	0.79	1.10	2.28	0 of #
2-NITROANILINE	0.75	0.77	1.25	0.73	0.59	1.19	1.24	1.23	1.88	1.20	1.42	0.79	1.10	2.28	0 of #
2-NITROPHENOL	0.75	0.77	1.25	0.73	0.59	1.19	1.24	1.23	1.88	1.20	1.42	0.79	1.10	2.28	0 of #
3,3'-DICHLOROENZIDINE	1.51	1.54	2.50	1.47	1.18	2.38	2.48	2.46	3.76	2.39	2.83	1.57	2.20	4.56	0 of #
3-NITROANILINE	0.75	0.77	1.25	0.73	0.59	1.19	1.24	1.23	1.88	1.20	1.42	0.79	1.10	2.28	0 of #
4-BROMOPHENYL PHENYL ETHER	0.75	0.77	1.25	0.73	0.59	1.19	1.24	1.23	1.88	1.20	1.42	0.79	1.10	2.28	0 of #
4-CHLORO-3-METHYLPHENOL	0.75	0.77	1.25	0.73	0.59	1.19	1.24	1.23	1.88	1.20	1.42	0.79	1.10	2.28	0 of #
4-CHLOROANILINE	0.75	0.77	1.25	0.73	0.59	1.19	1.24	1.23	1.88	1.20	1.42	0.79	1.10	2.28	0 of #
4-CHLOROPHENYL PHENYL ETHER	0.75	0.77	1.25	0.73	0.59	1.19	1.24	1.23	1.88	1.20	1.42	0.79	1.10	2.28	0 of #
4-METHYLPHENOL (INCLUDES 3-MET)	23.75	22.73	26.72	29.17	15.43	15.33	6.45	10.22	1.88	11.30	12.78	15.75	15.98	39.71	# of #
4-NITROANILINE	0.75	0.77	1.25	0.73	0.59	1.19	1.24	1.23	1.88	1.20	1.42	0.79	1.10	2.28	0 of #
4-NITROPHENOL	1.51	1.54	2.50	1.47	1.18	2.38	2.48	2.46	3.76	2.39	2.83	1.57	2.20	4.56	0 of #
ACENAPHTHENE	0.75	0.77	1.25	0.73	0.59	1.19	1.24	1.23	1.88	1.20	1.42	0.79	1.10	2.28	0 of #
ACENAPHTHYLENE	0.75	0.77	1.25	0.73	0.59	1.19	1.24	1.23	1.88	1.20	1.42	0.79	1.10	2.28	0 of #
ANILINE	0.75	0.77	1.25	0.73	0.59	1.19	1.24	1.23	1.88	1.20	1.42	0.79	1.10	2.28	0 of #
ANTHRACENE	0.75	0.77	1.25	0.73	0.59	1.19	1.24	1.23	1.88	1.20	1.42	0.79	1.10	2.28	0 of #
BENZIDINE	3.78	3.86	6.24	3.66	9.40	5.95	6.19	6.16	9.41	5.98	7.08	3.93	5.87	15.79	2 of #
BENZO(A)ANTHRACENE	0.75	0.77	1.25	0.73	0.59	1.19	1.24	1.23	1.88	1.20	1.42	0.79	1.10	2.28	0 of #
BENZO(A)PYRENE	0.75	0.77	1.25	0.73	0.59	1.19	1.24	1.23	1.88	1.20	1.42	0.79	1.10	2.28	0 of #
BENZO(B)FLUORANTHENE	0.75	0.77	1.25	0.73	0.59	1.19	1.24	1.23	1.88	1.20	1.42	0.79	1.10	2.28	0 of #
BENZO(GHI)PERYLENE	0.75	0.77	1.25	0.73	0.59	1.19	1.24	1.23	1.88	1.20	1.42	0.79	1.10	2.28	0 of #

Table B-3 Nut Island Influent Loadings, Fiscal Year 1998, cont.

Semivolatile Organics (lbs/day)													Average	Maximum	Times Detected
	Jul	Aug	Sep	Oct	Nov	Dec	Jan	Feb	Mar	Apr	May	Jun			
BENZO(K)FLUORANTHENE	0.75	0.77	1.25	0.73	0.59	1.19	1.24	1.23	1.88	1.20	1.42	0.79	1.10	2.28	0 of #
BENZOIC ACID	23.77	17.76	34.18	13.11	13.62	18.89	9.95	26.74	3.76	6.54	7.48	18.39	16.26	68.36	# of #
BENZYL ALCOHOL	7.57	7.26	6.21	14.70	6.77	16.74	8.95	4.96	1.88	3.33	1.42	5.16	7.09	23.53	# of #
BIS(2-CHLOROETHOXY)METHANE	0.75	0.77	1.25	0.73	0.59	1.19	1.24	1.23	1.88	1.20	1.42	0.79	1.10	2.28	0 of #
BIS(2-CHLOROETHYL)ETHER	0.75	0.77	1.25	0.73	0.59	1.19	1.24	1.23	1.88	1.20	1.42	0.79	1.10	2.28	0 of #
BIS(2-ETHYLHEXYL)PHTHALATE	4.42	5.89	4.42	5.32	2.56	1.19	1.24	1.23	1.88	1.20	4.18	0.79	2.87	9.58	# of #
BUTYL BENZYL PHTHALATE	0.75	0.77	1.25	0.83	0.59	1.19	1.24	1.23	1.88	1.20	1.42	0.79	1.11	2.28	1 of #
CHRYSENE	0.75	0.77	1.25	0.73	0.59	1.19	1.24	1.23	1.88	1.20	1.42	0.79	1.10	2.28	0 of #
DIBENZO(A,H)ANTHRACENE	0.75	0.77	1.25	0.73	0.59	1.19	1.24	1.23	1.88	1.20	1.42	0.79	1.10	2.28	0 of #
DIBENZOFURAN	0.75	0.77	1.25	0.73	0.59	1.19	1.24	1.23	1.88	1.20	1.42	0.79	1.10	2.28	0 of #
DIETHYL PHTHALATE	3.21	1.86	2.68	5.26	3.45	2.47	2.72	1.23	1.88	1.20	1.42	3.19	2.52	5.88	# of #
DIMETHYL PHTHALATE	0.75	0.77	1.25	0.73	0.59	1.19	1.24	1.23	1.88	1.20	1.42	0.79	1.10	2.28	0 of #
DI-N-BUTYLPHTHALATE	0.75	0.77	1.25	0.92	0.59	1.19	1.24	1.23	1.88	1.20	1.42	0.79	1.12	2.28	1 of #
DI-N-OCTYLPHTHALATE	0.75	0.77	1.25	0.73	0.59	1.19	1.24	1.23	1.88	1.20	1.42	0.79	1.10	2.28	0 of #
FLUORANTHENE	0.75	0.77	1.25	0.73	0.59	1.19	1.24	1.23	1.88	1.20	1.42	0.79	1.10	2.28	0 of #
FLUORENE	0.75	0.77	1.25	0.73	0.59	1.19	1.24	1.23	1.88	1.20	1.42	0.79	1.10	2.28	0 of #
HEXACHLOROBENZENE	0.75	0.77	1.25	0.73	0.59	1.19	1.24	1.23	1.88	1.20	1.42	0.79	1.10	2.28	0 of #
HEXACHLOROBUTADIENE	0.75	0.77	1.25	0.73	0.59	1.19	1.24	1.23	1.88	1.20	1.42	0.79	1.10	2.28	0 of #
HEXACHLOROCYCLOPENTADIENE	3.77	3.86	6.24	3.66	2.95	5.95	6.19	6.16	9.41	5.98	7.08	3.93	5.50	11.39	0 of #
HEXACHLOROETHANE	0.75	0.77	1.25	0.73	0.59	1.19	1.24	1.23	1.88	1.20	1.42	0.79	1.10	2.28	0 of #
INDENO(1,2,3-CD)PYRENE	0.75	0.77	1.25	0.73	0.59	1.19	1.24	1.23	1.88	1.20	1.42	0.79	1.10	2.28	0 of #
ISOPHORONE	0.75	0.77	1.25	0.73	0.59	1.19	1.24	1.23	1.88	1.20	1.42	0.79	1.10	2.28	0 of #
NAPHTHALENE	0.75	0.77	1.25	0.73	0.59	1.19	1.24	1.23	1.88	1.20	1.42	0.79	1.10	2.28	0 of #
NITROBENZENE	0.75	0.77	1.25	0.73	0.59	1.19	1.24	1.23	1.88	1.20	1.42	0.79	1.10	2.28	0 of #
N-NITROSODIMETHYLAMINE	0.75	0.77	1.25	0.73	0.59	1.19	1.24	1.23	1.88	1.20	1.42	0.79	1.10	2.28	0 of #
N-NITROSODI-N-PROPYLAMINE	0.75	0.77	1.25	0.73	0.59	1.34	1.24	1.23	1.88	1.20	1.42	0.79	1.11	2.28	0 of #
N-NITROSODIPHENYLAMINE	0.75	0.77	1.25	0.73	0.59	1.19	1.24	1.23	1.88	1.20	1.42	0.79	1.10	2.28	0 of #
PENTACHLOROPHENOL	3.77	3.86	6.24	3.66	2.95	5.95	6.19	6.16	9.41	5.98	7.08	3.93	5.50	11.39	0 of #
PHENANTHRENE	0.75	0.77	1.25	0.73	0.59	1.19	0.12	0.12	0.19	0.12	0.14	0.08	0.50	1.81	0 of #
PHENOL	7.33	1.54	2.50	10.43	3.55	2.38	2.48	2.46	3.76	2.39	2.83	3.85	3.80	17.66	7 of #
PYRENE	0.75	0.77	1.25	0.73	0.59	1.19	1.24	1.23	1.88	1.20	1.42	0.79	1.10	2.28	0 of #

Table B-3 Nut Island Influent Loadings, Fiscal Year 1998, cont.

Volatile Organics (lbs/day)													Times		
	Jul	Aug	Sep	Oct	Nov	Dec	Jan	Feb	Mar	Apr	May	Jun	Average	Maximum	Detected
1,1,1-TRICHLOROETHANE	0.40	0.35	0.38	0.35	0.28	0.41	0.63	0.57	0.84	0.52	0.66	0.37	0.49	1.04	0 of #
1,1,2,2-TETRACHLOROETHANE	0.40	0.35	0.38	0.35	0.28	0.41	0.63	0.57	0.84	0.52	0.66	0.37	0.49	1.04	0 of #
1,1,2-TRICHLOROETHANE	0.40	0.35	0.38	0.35	0.28	0.41	0.63	0.57	0.84	0.52	0.66	0.37	0.49	1.04	0 of #
1,1-DICHLOROETHANE	0.40	0.35	0.38	0.35	0.28	0.41	0.63	0.57	0.84	0.52	0.66	0.37	0.49	1.04	0 of #
1,1-DICHLOROETHENE	0.40	0.35	0.38	0.35	0.28	0.41	0.63	0.57	0.84	0.52	0.66	0.37	0.49	1.04	0 of #
1,2-DICHLOROBENZENE	0.40	0.35	0.38	0.35	0.28	0.41	0.63	0.57	0.84	0.52	0.66	0.37	0.49	1.04	0 of #
1,2-DICHLOROETHANE	0.40	0.35	0.38	0.35	0.28	0.41	0.63	0.57	0.84	0.52	0.66	0.37	0.49	1.04	0 of #
1,2-DICHLOROPROPANE	0.40	0.35	0.38	0.35	0.28	0.41	0.63	0.57	0.84	0.52	0.66	0.37	0.49	1.04	0 of #
1,3-DICHLOROBENZENE	0.40	0.35	0.38	0.35	1.28	0.41	0.63	0.57	0.84	0.52	0.66	0.37	0.54	2.24	1 of #
1,4-DICHLOROBENZENE	1.60	1.24	2.21	1.40	1.18	1.05	0.63	0.57	0.84	0.52	0.66	0.37	1.02	2.62	# of #
2-BUTANONE	3.23	20.46	31.02	3.20	61.44	69.71	44.69	5.04	2.12	1.24	3.04	2.33	19.46	96.60	# of #
2-CHLOROETHYL VINYL ETHER	0.40	0.35	0.38	0.35	0.28	0.41	0.63	0.57	0.84	0.52	0.66	0.37	0.49	1.04	0 of #
2-HEXANONE	0.40	0.35	0.38	0.35	1.11	0.41	0.63	0.57	0.84	0.52	0.66	0.37	0.53	1.89	1 of #
4-METHYL-2-PENTANONE	0.40	0.35	0.38	0.35	0.28	0.41	0.63	0.57	0.84	0.52	0.66	1.04	0.54	2.38	1 of #
ACETONE	153.06	142.65	139.25	134.55	125.48	94.69	87.80	142.20	178.13	161.74	92.26	89.58	128.54	215.95	# of #
ACROLEIN	0.40	0.35	0.38	0.35	0.28	0.41	0.63	0.57	0.84	0.52	0.66	0.37	0.49	1.04	0 of #
ACRYLONITRILE	0.40	0.35	0.38	0.35	0.28	0.41	0.63	0.57	0.84	0.52	0.66	0.37	0.49	1.04	0 of #
BENZENE	0.40	0.35	0.38	0.35	0.28	0.41	0.63	0.57	0.84	0.52	0.66	0.37	0.49	1.04	0 of #
BROMODICHLOROMETHANE	0.40	0.35	0.38	0.35	0.28	0.41	0.63	0.57	0.84	0.52	0.66	0.37	0.49	1.04	0 of #
BROMOFORM	0.40	0.35	0.38	0.35	0.28	0.41	0.63	0.57	0.84	0.52	0.66	0.37	0.49	1.04	0 of #
BROMOMETHANE	0.40	0.35	0.38	0.35	0.28	0.41	0.63	0.57	0.84	0.52	0.66	0.37	0.49	1.04	0 of #
CARBON DISULFIDE	0.78	0.99	0.57	0.65	0.28	1.24	0.63	2.61	0.84	0.52	0.66	0.37	0.86	6.69	# of #
CARBON TETRACHLORIDE	0.40	0.35	0.38	0.35	0.28	0.41	0.63	0.57	0.84	0.52	0.66	0.37	0.49	1.04	0 of #
CHLOROBENZENE	0.40	0.35	0.38	0.35	0.28	0.41	0.63	0.57	0.84	0.52	0.66	0.37	0.49	1.04	0 of #
CHLOROETHANE	0.40	0.35	0.38	0.35	0.28	0.41	0.63	0.57	0.84	0.52	0.66	0.37	0.49	1.04	0 of #
CHLOROFORM	4.01	3.63	3.90	2.98	2.45	3.03	2.75	4.00	4.82	4.46	6.18	3.97	3.89	7.10	# of #
CHLOROMETHANE	0.40	0.35	0.38	0.35	1.57	0.41	0.63	0.57	0.84	0.52	0.66	0.37	0.56	2.89	1 of #
CIS-1,2-DICHLOROETHENE	0.40	0.35	0.38	0.35	0.28	0.41	0.63	0.57	0.84	0.52	0.66	0.37	0.49	1.04	0 of #
CIS-1,3-DICHLOROPROPENE	0.40	0.35	0.38	0.35	0.28	0.41	0.63	0.57	0.84	0.52	0.66	0.37	0.49	1.04	0 of #
DIBROMOCHLOROMETHANE	0.40	0.35	0.38	0.35	0.28	0.41	0.63	0.57	0.84	0.52	0.66	0.37	0.49	1.04	0 of #
ETHYLBENZENE	0.40	0.35	0.38	0.35	0.28	0.41	0.63	0.57	0.84	0.52	0.66	0.37	0.49	1.04	0 of #
M,P-XYLENE	0.56	0.35	0.59	0.47	1.36	1.19	0.63	0.57	0.84	0.52	0.66	0.37	0.66	2.74	5 of #
METHYLENE CHLORIDE	1.15	2.55	3.69	3.44	1.02	1.84	0.63	1.48	4.07	2.52	2.05	7.00	2.67	17.47	# of #
O-XYLENE	0.40	0.35	0.38	0.35	0.28	0.41	0.63	0.57	0.84	0.52	0.66	0.37	0.49	1.04	0 of #

Table B-3 Nut Island Influent Loadings, Fiscal Year 1998, cont.

Volatile Organics (lbs/day)															Times
	Jul	Aug	Sep	Oct	Nov	Dec	Jan	Feb	Mar	Apr	May	Jun	Average	Maximum	Detected
STYRENE	0.40	0.35	0.38	0.35	0.28	0.41	0.63	0.57	0.84	0.52	0.66	5.08	0.89	14.47	1 of #
TETRACHLOROETHENE	2.10	1.72	2.08	3.13	6.72	3.83	5.86	8.22	7.22	6.68	9.21	4.43	5.05	15.57	# of #
TOLUENE	4.48	5.28	4.83	3.39	3.44	2.19	2.50	2.05	1.77	1.35	0.66	3.41	2.93	7.50	# of #
TRANS-1,2-DICHLOROETHENE	0.40	0.35	0.38	0.35	0.28	0.41	0.63	0.57	0.84	0.52	0.66	0.37	0.49	1.04	0 of #
TRANS-1,3-DICHLOROPROPENE	0.40	0.35	0.38	0.35	0.28	0.41	0.63	0.57	0.84	0.52	0.66	0.37	0.49	1.04	0 of #
TRICHLOROETHENE	0.40	0.35	0.38	0.35	0.28	0.41	0.63	0.57	0.84	0.52	0.66	0.37	0.49	1.04	0 of #
TRICHLOROFLUOROMETHANE	0.40	0.35	0.38	0.35	0.28	0.41	0.63	0.57	0.84	0.52	0.66	0.37	0.49	1.04	0 of #
VINYL ACETATE	0.40	0.35	0.38	0.35	0.28	0.41	0.63	0.57	0.84	0.52	0.66	0.37	0.49	1.04	0 of #
VINYL CHLORIDE	0.40	0.35	0.38	0.35	0.28	0.41	0.63	0.57	0.84	0.52	0.66	0.37	0.49	1.04	0 of #

Notes:

Results in ***bold italics*** indicate one or more detects in the month.

Yearly averages are calculated from individual results collected in the fiscal year.

Non-detected compounds are assumed to equal one half of the detection limit for metals and inorganics and one tenth of the reporting limit for organic compounds.

Table B-4 Nut Island Effluent Characterization, Fiscal Year 1998

Metals (ug/L)													Average Maximum		Times
	Jul	Aug	Sep	Oct	Nov	Dec	Jan	Feb	Mar	Apr	May	Jun	Average	Maximum	Detected
ANTIMONY	17.78	20.00	20.00	20.00	20.00	20.00	20.00	20.00	20.00	20.00	20.00	20.00	19.84	20.00	0 of 86
ARSENIC	1.10	1.40	1.10	1.10	1.10	0.40	0.40	0.46	0.64	0.48	0.40	0.44	0.74	2.20	4 of 86
BERYLLIUM	0.50	0.50	0.50	0.50	0.50	0.50	0.50	0.50	0.50	0.50	0.50	0.50	0.50	0.50	0 of 85
BORON	255.91	346.84	378.94	367.17	216.52	234.56	125.00	178.45	125.00	125.00	125.00	132.04	212.15	458.00	40 of 86
CADMIUM	1.00	1.00	1.00	1.00	1.00	1.00	1.00	1.00	1.00	1.00	1.00	1.00	1.00	1.00	0 of 86
CHROMIUM	2.55	2.48	2.72	4.54	2.58	2.05	2.16	3.02	2.00	1.81	1.65	1.50	2.47	7.08	30 of 87
COPPER	66.51	83.21	61.33	65.30	56.89	58.94	46.74	46.25	42.80	45.03	46.25	38.70	54.04	225.00	87 of 87
HEXAVALENT CHROMIUM	8.39	5.50	5.50	5.50	5.50	5.50	5.50	5.50	5.50	5.50	5.50	5.50	5.74	14.60	1 of 37
IRON	1574.67	1243.06	1560.70	1230.95	1238.06	1171.65	968.46	1002.16	809.27	879.70	971.14	873.11	1103.68	3220.00	86 of 86
LEAD	5.08	5.57	5.98	6.12	6.58	4.13	3.60	2.97	3.27	3.57	4.88	4.05	4.41	12.30	79 of 86
MERCURY	0.14	0.17	0.11	0.14	0.13	0.12	0.08	0.10	0.09	0.08	0.06	0.08	0.11	0.38	73 of 86
MOLYBDENUM	4.41	7.81	5.00	4.98	5.05	2.98	2.50	3.00	2.73	3.12	4.51	2.50	3.84	27.60	24 of 86
NICKEL	4.01	4.00	4.00	4.54	4.00	4.00	4.00	4.63	4.00	4.00	4.00	4.00	4.12	8.41	4 of 86
SELENIUM	1.10	1.10	1.10	1.10	0.97	0.75	0.50	0.52	0.45	0.81	0.51	0.45	0.74	2.86	2 of 86
SILVER	2.01	2.24	2.47	3.03	2.28	5.29	1.86	1.39	1.89	1.64	1.12	3.52	2.33	20.25	66 of 86
THALLIUM	1.10	1.10	1.10	1.10	0.98	0.50	0.50	0.75	0.58	0.50	0.50	0.56	0.76	1.40	4 of 86
ZINC	97.79	98.35	75.11	76.96	66.58	63.88	52.84	50.63	45.48	42.66	51.90	47.26	62.59	210.00	87 of 87

Cyanide and Phenols (ug/L)													Average Maximum		Times
	Jul	Aug	Sep	Oct	Nov	Dec	Jan	Feb	Mar	Apr	May	Jun	Average	Maximum	Detected
CYANIDE	5.00	41.59	7.57	5.00	5.00	14.25	10.88	7.72	6.69	5.00	5.00	5.00	9.89	117.00	8 of 37
TOTAL PHENOLS	46.99	36.53	52.26	96.60	53.91	50.05	13.08	20.23	10.81	32.40	8.80	42.68	36.03	166.00	31 of 35

Oil and Grease, Petroleum Hydrocarbons, and Surfactants (mg/L)													Average Maximum		Times
	Jul	Aug	Sep	Oct	Nov	Dec	Jan	Feb	Mar	Apr	May	Jun	Average	Maximum	Detected
PETROLEUM HYDROCARBON	2.72	1.28	2.04	1.82	1.12	0.91	0.75	0.79	0.47	0.60	0.66	0.42	1.11	13.00	76 of 76
TOTAL PETROLEUM HYDROCARBON	3.38	3.66	7.16	6.24	3.46	2.82	2.43	17.86	1.60	1.81	8.34	1.71	5.42	67.90	74 of 79
FATS OIL AND GREASE	32.06	33.54	29.93	32.44	23.54	22.52	15.39	31.89	21.05	17.98	14.42	11.22	24.17	81.70	88 of 89
MBAS	6.92	7.27	7.13	7.19	5.85	5.21	3.85	3.61	2.95	4.27	4.21	4.98	5.01	8.99	35 of 35

Table B-4 Nut Island Effluent Characterization, Fiscal Year 1998, cont.

Organochlorine Pesticides and PCBs (ug/L)	Organochlorine Pesticides and PCBs (ug/L)												Times		
	Jul	Aug	Sep	Oct	Nov	Dec	Jan	Feb	Mar	Apr	May	Jun	Average	Maximum	Detected
4,4'-DDD	0.002	0.002	0.002	0.002	0.002	0.002	0.002	0.002	0.002	0.002	0.002	0.002	0.002	0.002	0 of 35
4,4'-DDE	0.002	0.002	0.005	0.002	0.002	0.002	0.002	0.002	0.002	0.002	0.007	0.002	0.002	0.012	2 of 35
4,4'-DDT	0.002	0.002	0.002	0.002	0.002	0.002	0.002	0.002	0.002	0.002	0.002	0.002	0.002	0.002	0 of 35
ALDRIN	0.002	0.002	0.002	0.002	0.002	0.002	0.002	0.002	0.002	0.002	0.002	0.002	0.002	0.002	0 of 35
ALPHA-BHC	0.002	0.002	0.002	0.002	0.002	0.002	0.002	0.002	0.002	0.002	0.002	0.002	0.002	0.002	0 of 35
ALPHA-CHLORDANE	0.002	0.002	0.002	0.002	0.002	0.002	0.002	0.002	0.002	0.002	0.010	0.002	0.002	0.017	1 of 35
AROCLOR-1016	0.051	0.054	0.053	0.051	0.052	0.051	0.052	0.051	0.052	0.051	0.054	0.051	0.052	0.058	0 of 35
AROCLOR-1221	0.102	0.108	0.106	0.102	0.103	0.102	0.104	0.103	0.104	0.101	0.109	0.103	0.104	0.116	0 of 35
AROCLOR-1232	0.051	0.054	0.053	0.051	0.052	0.051	0.052	0.051	0.052	0.051	0.054	0.051	0.052	0.058	0 of 35
AROCLOR-1242	0.051	0.054	0.053	0.051	0.052	0.051	0.052	0.051	0.052	0.051	0.054	0.051	0.052	0.058	0 of 35
AROCLOR-1248	0.051	0.054	0.053	0.051	0.052	0.051	0.052	0.051	0.052	0.051	0.054	0.051	0.052	0.058	0 of 35
AROCLOR-1254	0.051	0.054	0.053	0.051	0.052	0.051	0.052	0.051	0.052	0.051	0.054	0.051	0.052	0.058	0 of 35
AROCLOR-1260	0.051	0.054	0.053	0.051	0.052	0.051	0.052	0.051	0.052	0.051	0.054	0.051	0.052	0.058	0 of 35
BETA-BHC	0.002	0.002	0.002	0.002	0.002	0.002	0.002	0.002	0.002	0.002	0.002	0.002	0.002	0.002	0 of 35
CHLORDANE (TECHNICAL)	0.051	0.054	0.053	0.051	0.052	0.051	0.052	0.051	0.052	0.051	0.054	0.051	0.052	0.058	0 of 35
DELTA-BHC	0.002	0.002	0.002	0.002	0.002	0.002	0.002	0.002	0.002	0.002	0.002	0.002	0.002	0.002	0 of 35
DIELDRIN	0.002	0.002	0.002	0.002	0.002	0.002	0.002	0.002	0.002	0.002	0.002	0.002	0.002	0.002	0 of 35
ENDOSULFAN I	0.002	0.002	0.002	0.002	0.002	0.002	0.002	0.002	0.002	0.002	0.002	0.002	0.002	0.002	0 of 35
ENDOSULFAN II	0.002	0.002	0.002	0.002	0.002	0.002	0.002	0.002	0.002	0.002	0.002	0.002	0.002	0.002	0 of 35
ENDOSULFAN SULFATE	0.002	0.002	0.002	0.002	0.002	0.002	0.002	0.002	0.002	0.002	0.002	0.002	0.002	0.002	0 of 35
ENDRIN	0.002	0.002	0.002	0.002	0.002	0.002	0.002	0.002	0.002	0.002	0.002	0.002	0.002	0.002	0 of 35
ENDRIN ALDEHYDE	0.002	0.002	0.002	0.002	0.002	0.002	0.002	0.002	0.002	0.002	0.002	0.002	0.002	0.002	0 of 35
ENDRIN KETONE	0.002	0.002	0.002	0.002	0.002	0.002	0.002	0.002	0.002	0.002	0.002	0.002	0.002	0.002	0 of 35
GAMMA-BHC (LINDANE)	0.002	0.002	0.002	0.002	0.002	0.002	0.002	0.002	0.002	0.002	0.002	0.002	0.002	0.002	0 of 35
GAMMA-CHLORDANE	0.002	0.002	0.002	0.002	0.002	0.002	0.002	0.002	0.002	0.007	0.010	0.002	0.003	0.017	2 of 35
HEPTACHLOR	0.002	0.002	0.002	0.002	0.002	0.002	0.002	0.002	0.002	0.002	0.002	0.002	0.002	0.002	0 of 35
HEPTACHLOR EPOXIDE	0.002	0.002	0.002	0.002	0.002	0.002	0.002	0.002	0.002	0.002	0.002	0.002	0.002	0.002	0 of 35
METHOXYCHLOR	0.020	0.022	0.021	0.020	0.021	0.020	0.021	0.021	0.021	0.020	0.022	0.021	0.021	0.023	0 of 35
TOXAPHENE	0.051	0.054	0.053	0.051	0.052	0.051	0.052	0.051	0.052	0.051	0.054	0.051	0.052	0.058	0 of 35

Table B-4 Nut Island Effluent Characterization, Fiscal Year 1998, cont.

Semivolatile Organics (ug/L)													Times		
	Jul	Aug	Sep	Oct	Nov	Dec	Jan	Feb	Mar	Apr	May	Jun	Average	Maximum	Detected
1,2,4-TRICHLOROBENZENE	1.00	1.06	1.07	1.03	1.03	1.03	1.35	1.01	1.03	1.02	1.07	1.07	1.07	2.10	0 of 35
1,2-DICHLOROBENZENE	1.00	1.06	1.07	1.03	1.03	1.03	1.35	1.01	1.03	1.02	1.07	1.07	1.07	2.10	0 of 35
1,2-DIPHENYLHYDRAZINE (AS AZOB)	1.00	1.06	1.07	1.03	1.03	1.03	1.35	1.01	1.03	1.02	1.07	1.07	1.07	2.10	0 of 35
1,3-DICHLOROBENZENE	1.00	1.06	1.07	1.03	1.03	1.03	1.35	1.01	1.03	1.02	1.07	1.07	1.07	2.10	0 of 35
1,4-DICHLOROBENZENE	1.00	1.06	1.07	1.03	1.03	1.03	1.35	1.01	1.03	1.02	1.07	1.07	1.07	2.10	0 of 35
2,2'-OXYBIS(1-CHLOROPROPANE)	1.00	1.06	1.07	1.03	1.03	1.03	1.35	1.01	1.03	1.02	1.07	1.07	1.07	2.10	0 of 35
2,4,5-TRICHLOROPHENOL	1.00	1.06	1.07	1.03	1.03	1.03	1.35	1.01	1.03	1.02	1.07	1.07	1.07	2.10	0 of 35
2,4,6-TRICHLOROPHENOL	1.00	1.06	1.07	1.03	1.03	1.03	1.35	1.01	1.03	1.02	1.07	1.07	1.07	2.10	0 of 35
2,4-DICHLOROPHENOL	1.00	1.06	1.07	1.03	1.03	1.03	1.35	1.01	1.03	1.02	1.07	1.07	1.07	2.10	0 of 35
2,4-DIMETHYLPHENOL	1.00	1.06	1.07	1.03	1.03	1.03	1.35	1.01	1.03	1.02	1.07	1.07	1.07	2.10	0 of 35
2,4-DINITROPHENOL	2.00	2.12	2.14	2.06	2.06	2.05	2.70	2.02	2.05	2.04	2.15	2.15	2.14	4.20	0 of 35
2,4-DINITROTOLUENE	1.00	1.06	1.07	1.03	1.03	1.03	1.35	1.01	1.03	1.02	1.07	1.07	1.07	2.10	0 of 35
2,6-DINITROTOLUENE	1.00	1.06	1.07	1.03	1.03	1.03	1.35	1.01	1.03	1.02	1.07	1.07	1.07	2.10	0 of 35
2-CHLORONAPHTHALENE	1.00	1.06	1.07	1.03	1.03	1.03	1.35	1.01	1.03	1.02	1.07	1.07	1.07	2.10	0 of 35
2-CHLOROPHENOL	1.00	1.06	1.07	1.03	1.03	1.03	1.35	1.01	1.03	1.02	1.07	1.07	1.07	2.10	0 of 35
2-METHYL-4,6-DINITROPHENOL	10.00	10.60	10.70	10.28	10.28	10.26	13.52	10.12	10.27	10.18	10.73	10.74	10.70	21.00	0 of 35
2-METHYLNAPHTHALENE	1.00	1.06	1.07	1.03	1.03	1.03	1.35	1.01	1.03	1.02	1.07	1.07	1.07	2.10	0 of 35
2-METHYLPHENOL	1.00	1.06	1.07	1.03	1.03	2.76	1.35	1.01	1.03	1.02	1.07	1.07	1.22	6.43	1 of 35
2-NITROANILINE	1.00	1.06	1.07	1.03	1.03	1.03	1.35	1.01	1.03	1.02	1.07	1.07	1.07	2.10	0 of 35
2-NITROPHENOL	1.00	1.06	1.07	1.03	1.03	1.03	1.35	1.01	1.03	1.02	1.07	1.07	1.07	2.10	0 of 35
3,3'-DICHLOROBENZIDINE	2.00	2.12	2.14	2.06	2.06	2.05	2.70	2.02	2.05	2.04	2.15	2.15	2.14	4.20	0 of 35
3-NITROANILINE	1.00	1.06	1.07	1.03	1.03	1.03	1.35	1.01	1.03	1.02	1.07	1.07	1.07	2.10	0 of 35
4-BROMOPHENYL PHENYL ETHER	1.00	1.06	1.07	1.03	1.03	1.03	1.35	1.01	1.03	1.02	1.07	1.07	1.07	2.10	0 of 35
4-CHLORO-3-METHYLPHENOL	1.00	1.06	1.07	1.03	1.03	1.03	1.35	1.01	1.03	1.02	1.07	1.07	1.07	2.10	0 of 35
4-CHLOROANILINE	1.00	1.06	1.07	1.03	1.03	1.03	1.35	1.01	1.03	1.02	1.07	1.07	1.07	2.10	0 of 35
4-CHLOROPHENYL PHENYL ETHER	1.00	1.06	1.07	1.03	1.03	1.03	1.35	1.01	1.03	1.02	1.07	1.07	1.07	2.10	0 of 35
4-METHYLPHENOL (INCLUDES 3-MET)	28.01	34.22	34.78	37.49	28.90	22.59	10.28	10.33	1.03	10.19	12.88	23.05	18.66	40.90	32 of 35
4-NITROANILINE	1.00	1.06	1.07	1.03	1.03	1.03	1.35	1.01	1.03	1.02	1.07	1.07	1.07	2.10	0 of 35
4-NITROPHENOL	2.00	2.12	2.14	2.06	2.06	2.05	2.70	2.02	2.05	2.04	2.15	2.15	2.14	4.20	0 of 35
ACENAPHTHENE	1.00	1.06	1.07	1.03	1.03	1.03	1.35	1.01	1.03	1.02	1.07	1.07	1.07	2.10	0 of 35
ACENAPHTHYLENE	1.00	1.06	1.07	1.03	1.03	1.03	1.35	1.01	1.03	1.02	1.07	1.07	1.07	2.10	0 of 35
ANILINE	1.00	1.06	1.07	1.03	1.03	1.03	1.35	1.01	1.03	1.02	1.07	1.07	1.07	2.10	0 of 35
ANTHRACENE	1.00	1.06	1.07	1.03	1.03	1.03	1.35	1.01	1.03	1.02	1.07	1.07	1.07	2.10	0 of 35
BENZIDINE	5.00	5.30	5.35	5.14	5.14	5.13	6.76	5.06	5.14	5.09	5.37	5.37	5.35	10.50	0 of 35
BENZO(A)ANTHRACENE	1.00	1.06	1.07	1.03	1.03	1.03	1.35	1.01	1.03	1.02	1.07	1.07	1.07	2.10	0 of 35
BENZO(A)PYRENE	1.00	1.06	1.07	1.03	1.03	1.03	1.35	1.01	1.03	1.02	1.07	1.07	1.07	2.10	0 of 35
BENZO(B)FLUORANTHENE	1.00	1.06	1.07	1.03	1.03	1.03	1.35	1.01	1.03	1.02	1.07	1.07	1.07	2.10	0 of 35
BENZO(GHI)PERYLENE	1.00	1.06	1.07	1.03	1.03	1.03	1.35	1.01	1.03	1.02	1.07	1.07	1.07	2.10	0 of 35
BENZO(K)FLUORANTHENE	1.00	1.06	1.07	1.03	1.03	1.03	1.35	1.01	1.03	1.02	1.07	1.07	1.07	2.10	0 of 35
BENZOIC ACID	44.53	26.60	15.17	12.80	43.08	2.05	11.65	14.49	5.54	18.00	11.85	8.96	16.23	68.90	19 of 35

Table B-4 Nut Island Effluent Characterization, Fiscal Year 1998, cont.

Semivolatile Organics (ug/L)													Times		
	Jul	Aug	Sep	Oct	Nov	Dec	Jan	Feb	Mar	Apr	May	Jun	Average	Maximum	Detected
BENZYL ALCOHOL	9.00	10.10	11.51	14.94	12.04	21.27	11.12	8.20	2.70	3.85	4.02	7.90	9.61	29.40	29 of 35
BIS(2-CHLOROETHOXY)METHANE	1.00	1.06	1.07	1.03	1.03	1.03	1.35	1.01	1.03	1.02	1.07	1.07	1.07	2.10	0 of 35
BIS(2-CHLOROETHYL)ETHER	1.00	1.06	1.07	1.03	1.03	1.03	1.35	1.01	1.03	1.02	1.07	1.07	1.07	2.10	0 of 35
BIS(2-ETHYLHEXYL)PHTHALATE	4.71	4.73	4.91	2.01	4.77	3.57	1.35	1.01	1.03	1.02	1.07	1.07	2.45	8.31	10 of 35
BUTYL BENZYL PHTHALATE	1.00	1.06	1.07	1.03	1.03	1.03	1.35	1.01	1.03	1.02	1.07	1.07	1.07	2.10	0 of 35
CHRYSENE	1.00	1.06	1.07	1.03	1.03	1.03	1.35	1.01	1.03	1.02	1.07	1.07	1.07	2.10	0 of 35
DIBENZO(A,H)ANTHRACENE	1.00	1.06	1.07	1.03	1.03	1.03	1.35	1.01	1.03	1.02	1.07	1.07	1.07	2.10	0 of 35
DIBENZOFURAN	1.00	1.06	1.07	1.03	1.03	1.03	1.35	1.01	1.03	1.02	1.07	1.07	1.07	2.10	0 of 35
DIETHYL PHTHALATE	3.92	4.50	6.34	5.66	6.85	4.11	1.35	2.43	1.03	1.02	1.07	5.07	3.24	7.40	19 of 35
DIMETHYL PHTHALATE	1.00	1.06	1.07	1.03	1.03	1.03	1.35	1.01	1.03	1.02	1.07	1.07	1.07	2.10	0 of 35
DI-N-BUTYLPHTHALATE	1.00	1.06	1.07	1.03	1.03	1.03	1.35	1.01	1.03	1.02	1.07	1.07	1.07	2.10	0 of 35
DI-N-OCTYLPHTHALATE	1.00	1.06	1.07	1.03	1.03	1.03	1.35	1.01	1.03	1.02	1.07	1.07	1.07	2.10	0 of 35
FLUORANTHENE	1.00	1.06	1.07	1.03	1.03	1.03	1.35	1.01	1.03	1.02	1.07	1.07	1.07	2.10	0 of 35
FLUORENE	1.00	1.06	1.07	1.03	1.03	1.03	1.35	1.01	1.03	1.02	1.07	1.07	1.07	2.10	0 of 35
HEXACHLOROBENZENE	1.00	1.06	1.07	1.03	1.03	1.03	1.35	1.01	1.03	1.02	1.07	1.07	1.07	2.10	0 of 35
HEXACHLOROBUTADIENE	1.00	1.06	1.07	1.03	1.03	1.03	1.35	1.01	1.03	1.02	1.07	1.07	1.07	2.10	0 of 35
HEXACHLOROCYCLOPENTADIENE	5.00	5.30	5.35	5.14	5.14	5.13	6.76	5.06	5.14	5.09	5.37	5.37	5.35	10.50	0 of 35
HEXACHLOROETHANE	1.00	1.06	1.07	1.03	1.03	1.03	1.35	1.01	1.03	1.02	1.07	1.07	1.07	2.10	0 of 35
INDENO(1,2,3-CD)PYRENE	1.00	1.06	1.07	1.03	1.03	1.03	1.35	1.01	1.03	1.02	1.07	1.07	1.07	2.10	0 of 35
ISOPHORONE	1.00	1.06	1.07	1.03	1.03	1.03	1.35	1.01	1.03	1.02	1.07	1.07	1.07	2.10	0 of 35
NAPHTHALENE	1.00	1.06	1.07	1.03	1.03	1.03	1.35	1.01	1.03	1.02	1.07	1.07	1.07	2.10	0 of 35
NITROBENZENE	1.00	1.06	1.07	1.03	1.03	1.03	1.35	1.01	1.03	1.02	1.07	1.07	1.07	2.10	0 of 35
N-NITROSODIMETHYLAMINE	1.00	1.06	1.07	1.03	1.03	1.03	1.35	1.01	1.03	1.02	1.07	1.07	1.07	2.10	0 of 35
N-NITROSODI-N-PROPYLAMINE	1.00	1.06	1.07	1.03	1.03	1.02	1.35	1.01	1.03	1.02	1.07	1.07	1.07	2.10	0 of 34
N-NITROSODIPHENYLAMINE	1.00	1.06	1.07	1.03	1.03	1.03	1.35	1.01	1.03	1.02	1.07	1.07	1.07	2.10	0 of 35
PENTACHLOROPHENOL	5.00	5.30	5.35	5.14	5.14	5.13	6.76	5.06	5.14	5.09	5.37	5.37	5.35	10.50	0 of 35
PHENANTHRENE	1.00	1.06	1.07	1.03	1.03	1.03	0.14	0.10	0.10	0.10	0.11	0.11	0.54	1.11	0 of 35
PHENOL	4.51	2.12	2.14	9.46	6.47	5.09	2.70	2.02	2.05	2.04	2.15	2.15	3.58	16.80	7 of 35
PYRENE	1.00	1.06	1.07	1.03	1.03	1.03	1.35	1.01	1.03	1.02	1.07	1.07	1.07	2.10	0 of 35

Table B-4 Nut Island Effluent Characterization, Fiscal Year 1998, cont.

Volatile Organics (ug/L)													Average Maximum		Times
	Jul	Aug	Sep	Oct	Nov	Dec	Jan	Feb	Mar	Apr	May	Jun	Average	Maximum	Detected
1,1,1-TRICHLOROETHANE	0.50	0.50	0.50	0.50	0.50	0.50	<i>1.15</i>	0.50	0.50	0.50	0.50	0.50	0.58	2.99	1 of 36
1,1,2,2-TETRACHLOROETHANE	0.50	0.50	0.50	0.50	0.50	0.50	0.50	0.50	0.50	0.50	0.50	0.50	0.50	0.50	0 of 36
1,1,2-TRICHLOROETHANE	0.50	0.50	0.50	0.50	0.50	0.50	0.50	0.50	0.50	0.50	0.50	0.50	0.50	0.50	0 of 36
1,1-DICHLOROETHANE	0.50	0.50	0.50	0.50	0.50	0.50	0.50	0.50	0.50	0.50	0.50	0.50	0.50	0.50	0 of 36
1,1-DICHLOROETHENE	0.50	0.50	0.50	0.50	0.50	0.50	0.50	0.50	0.50	0.50	0.50	0.50	0.50	0.50	0 of 36
1,2-DICHLOROBENZENE	0.50	0.50	0.50	0.50	0.50	<i>1.37</i>	0.50	0.50	0.50	0.50	0.50	0.50	0.57	2.94	1 of 36
1,2-DICHLOROETHANE	0.50	0.50	0.50	0.50	0.50	0.50	0.50	0.50	0.50	0.50	0.50	0.50	0.50	0.50	0 of 36
1,2-DICHLOROPROPANE	0.50	0.50	0.50	0.50	0.50	0.50	0.50	0.50	0.50	0.50	0.50	0.50	0.50	0.50	0 of 36
1,3-DICHLOROBENZENE	0.50	<i>0.74</i>	0.50	0.50	0.50	<i>1.35</i>	0.50	0.50	0.50	0.50	0.50	0.50	0.59	2.87	2 of 36
1,4-DICHLOROBENZENE	<i>1.70</i>	<i>1.75</i>	<i>2.95</i>	<i>2.38</i>	0.50	<i>1.81</i>	0.50	0.50	0.50	0.50	0.50	0.50	1.17	4.16	14 of 36
2-BUTANONE	<i>4.50</i>	<i>34.28</i>	<i>40.60</i>	<i>12.39</i>	<i>82.12</i>	<i>84.20</i>	<i>39.89</i>	<i>6.88</i>	0.50	<i>3.42</i>	0.50	<i>8.97</i>	26.34	95.20	26 of 36
2-CHLOROETHYL VINYL ETHER	0.50	0.50	0.50	0.50	0.50	0.50	0.50	0.50	0.50	0.50	0.50	0.50	0.50	0.50	0 of 36
2-HEXANONE	0.50	0.50	0.50	0.50	0.50	0.50	0.50	0.50	0.50	0.50	0.50	0.50	0.50	0.50	0 of 36
4-METHYL-2-PENTANONE	0.50	0.50	0.50	0.50	0.50	0.50	0.50	0.50	0.50	0.50	0.50	0.50	0.50	0.50	0 of 36
ACETONE	<i>169.94</i>	<i>160.70</i>	<i>175.78</i>	<i>178.51</i>	<i>148.73</i>	<i>137.15</i>	<i>80.04</i>	<i>137.28</i>	<i>116.29</i>	<i>126.37</i>	<i>112.35</i>	<i>130.02</i>	136.85	262.00	36 of 36
ACROLEIN	0.50	0.50	0.50	0.50	0.50	0.50	0.50	0.50	0.50	0.50	0.50	0.50	0.50	0.50	0 of 36
ACRYLONITRILE	0.50	0.50	0.50	0.50	0.50	0.50	0.50	0.50	0.50	0.50	0.50	0.50	0.50	0.50	0 of 36
BENZENE	0.50	0.50	0.50	0.50	0.50	0.50	0.50	0.50	0.50	0.50	0.50	0.50	0.50	0.50	0 of 36
BROMODICHLOROMETHANE	<i>2.23</i>	<i>1.03</i>	<i>1.55</i>	<i>1.16</i>	0.50	0.50	0.50	0.50	0.50	0.50	0.50	0.50	0.83	3.18	10 of 36
BROMOFORM	0.50	0.50	0.50	0.50	0.50	0.50	0.50	0.50	0.50	0.50	0.50	0.50	0.50	0.50	0 of 36
BROMOMETHANE	0.50	0.50	0.50	0.50	0.50	0.50	0.50	0.50	0.50	0.50	0.50	0.50	0.50	0.50	0 of 36
CARBON DISULFIDE	<i>1.53</i>	<i>2.59</i>	<i>1.58</i>	<i>1.45</i>	0.50	<i>1.60</i>	0.50	0.50	0.50	0.50	0.50	0.50	1.00	4.19	13 of 36
CARBON TETRACHLORIDE	0.50	0.50	0.50	0.50	0.50	0.50	0.50	0.50	0.50	0.50	0.50	0.50	0.50	0.50	0 of 36
CHLOROBENZENE	0.50	0.50	0.50	0.50	0.50	0.50	0.50	0.50	0.50	0.50	0.50	0.50	0.50	0.50	0 of 36
CHLOROETHANE	0.50	0.50	0.50	0.50	0.50	0.50	0.50	0.50	0.50	0.50	0.50	0.50	0.50	0.50	0 of 36
CHLOROFORM	<i>12.14</i>	<i>10.34</i>	<i>12.58</i>	<i>13.28</i>	<i>9.32</i>	<i>9.61</i>	<i>5.75</i>	<i>6.22</i>	<i>4.94</i>	<i>5.81</i>	<i>6.44</i>	<i>9.20</i>	8.41	18.20	36 of 36
CHLOROMETHANE	<i>0.75</i>	<i>1.40</i>	<i>1.47</i>	<i>1.93</i>	0.50	0.50	0.50	0.50	0.50	0.50	0.50	0.50	0.80	4.48	7 of 36
CIS-1,2-DICHLOROETHENE	0.50	0.50	0.50	0.50	0.50	0.50	0.50	0.50	0.50	0.50	0.50	0.50	0.50	0.50	0 of 36
CIS-1,3-DICHLOROPROPENE	0.50	0.50	0.50	0.50	0.50	0.50	0.50	0.50	0.50	0.50	0.50	0.50	0.50	0.50	0 of 36
DIBROMOCHLOROMETHANE	0.50	0.50	0.50	0.50	0.50	0.50	0.50	0.50	0.50	0.50	0.50	0.50	0.50	0.50	0 of 36
ETHYLBENZENE	0.50	<i>0.72</i>	0.50	0.50	0.50	0.50	0.50	0.50	0.50	0.50	0.50	0.50	0.52	1.14	1 of 36
M,P-XYLENE	0.50	0.50	<i>0.69</i>	<i>0.88</i>	0.50	<i>2.58</i>	0.50	0.50	0.50	0.50	0.50	0.50	0.73	6.90	3 of 36
METHYLENE CHLORIDE	<i>1.67</i>	<i>4.08</i>	<i>5.75</i>	<i>5.15</i>	<i>2.36</i>	<i>3.78</i>	<i>2.16</i>	<i>2.21</i>	<i>4.68</i>	<i>4.65</i>	<i>8.61</i>	<i>11.26</i>	3.84	24.50	29 of 36
O-XYLENE	0.50	0.50	0.50	0.50	0.50	0.50	0.50	0.50	0.50	0.50	0.50	0.50	0.50	0.50	0 of 36

Table B-4 Nut Island Effluent Characterization, Fiscal Year 1998, cont.

Volatile Organics (ug/L)													Times		
	Jul	Aug	Sep	Oct	Nov	Dec	Jan	Feb	Mar	Apr	May	Jun	Average	Maximum	Detected
STYRENE	0.50	0.50	0.50	0.50	0.50	3.84	0.50	0.50	0.50	0.50	0.50	0.50	0.78	9.87	1 of 36
TETRACHLOROETHENE	1.86	1.72	3.94	4.76	6.16	4.65	4.43	8.40	4.22	9.46	6.16	4.97	4.94	16.70	36 of 36
TOLUENE	5.12	5.66	6.29	4.63	4.41	3.11	1.87	2.22	0.50	0.50	0.50	3.73	3.00	9.44	24 of 36
TRANS-1,2-DICHLOROETHENE	0.50	0.50	0.50	0.50	0.50	0.50	0.50	0.50	0.50	0.50	0.50	0.50	0.50	0.50	0 of 36
TRANS-1,3-DICHLOROPROPENE	0.50	0.50	0.50	0.50	0.50	0.50	0.50	0.50	0.50	0.50	0.50	0.50	0.50	0.50	0 of 36
TRICHLOROETHENE	0.50	0.50	0.50	0.50	0.50	0.50	0.50	0.50	1.48	0.50	0.50	0.50	0.67	4.46	1 of 36
TRICHLOROFLUOROMETHANE	0.50	0.50	0.50	0.50	0.50	0.50	0.50	0.50	0.50	0.50	0.50	0.50	0.50	0.50	0 of 36
VINYL ACETATE	0.50	0.50	0.50	0.50	0.50	0.50	0.50	0.50	0.50	0.50	0.50	0.50	0.50	0.50	0 of 36
VINYL CHLORIDE	0.50	0.50	0.50	0.50	0.50	0.50	0.50	0.50	0.50	0.50	0.50	0.50	0.50	0.50	0 of 36

Notes:

Results in **bold italics** indicate one or more detects in the month.

Yearly averages are calculated from individual results collected in the fiscal year.

Non-detected compounds are assumed to equal one half of the detection limit for metals and inorganics and one tenth of the reporting limit for organic compounds.

Table B-5 Nut Island Effluent Loadings, Fiscal Year 1998

Metals (lbs/day)													Times		
	Jul	Aug	Sep	Oct	Nov	Dec	Jan	Feb	Mar	Apr	May	Jun	Average	Maximum	Detected
ANTIMONY	13.34	14.35	14.40	14.16	13.40	16.31	27.13	23.48	33.82	12.11	10.37	5.67	16.69	45.06	0 of 86
ARSENIC	0.83	1.01	0.79	0.78	0.74	0.33	0.54	0.54	1.08	0.29	0.21	0.12	0.62	2.05	4 of 86
BERYLLIUM	0.38	0.36	0.36	0.35	0.34	0.41	0.68	0.59	0.85	0.30	0.26	0.14	0.42	1.13	0 of 85
BORON	192.04	248.86	272.87	259.96	145.11	191.27	169.58	209.51	211.39	75.68	64.83	37.43	178.53	377.62	40 of 86
CADMIUM	0.75	0.72	0.72	0.71	0.67	0.82	1.36	1.17	1.69	0.61	0.52	0.28	0.84	2.25	0 of 86
CHROMIUM	1.92	1.78	1.96	3.21	1.73	1.67	2.93	3.55	3.39	1.10	0.86	0.43	2.08	7.55	30 of 87
COPPER	49.91	59.70	44.16	46.23	38.13	48.06	63.41	54.31	72.37	27.27	23.99	10.97	45.48	160.00	87 of 87
HEXAVALENT CHROMIUM	6.79	3.82	4.13	3.85	3.69	4.55	6.95	6.29	9.23	3.17	2.39	0.54	4.60	11.47	1 of 37
IRON	1181.65	891.92	1123.85	871.54	829.73	955.41	1313.85	1176.58	1368.59	532.63	503.64	247.51	928.80	2301.27	86 of 86
LEAD	3.82	4.00	4.31	4.33	4.41	3.37	4.88	3.49	5.52	2.16	2.53	1.15	3.71	8.60	79 of 86
MERCURY	0.10	0.12	0.08	0.10	0.09	0.10	0.11	0.12	0.15	0.05	0.03	0.02	0.09	0.32	73 of 86
MOLYBDENUM	3.31	5.60	3.60	3.53	3.39	2.43	3.39	3.52	4.62	1.89	2.34	0.71	3.23	19.61	24 of 86
NICKEL	3.01	2.87	2.88	3.22	2.68	3.26	5.43	5.44	6.76	2.42	2.07	1.13	3.46	10.39	4 of 86
SELENIUM	0.83	0.79	0.79	0.78	0.65	0.61	0.68	0.61	0.76	0.49	0.27	0.13	0.63	2.32	2 of 86
SILVER	1.51	1.61	1.78	2.11	1.53	4.31	2.53	1.63	3.20	0.99	0.58	1.00	1.96	17.78	66 of 86
THALLIUM	0.83	0.79	0.79	0.78	0.66	0.41	0.68	0.88	0.98	0.30	0.26	0.16	0.64	2.09	4 of 86
ZINC	73.38	70.56	54.09	54.49	44.62	52.09	71.68	59.44	76.91	25.83	26.91	13.40	52.67	174.53	87 of 87

Cyanide and Phenols (lbs/day)													Times		
	Jul	Aug	Sep	Oct	Nov	Dec	Jan	Feb	Mar	Apr	May	Jun	Average	Maximum	Detected
CYANIDE	4.05	28.86	5.69	3.50	3.36	11.80	13.75	8.83	11.24	2.88	2.17	0.49	7.93	79.57	8 of 37
TOTAL PHENOLS	35.46	26.35	37.72	68.66	30.59	42.14	15.54	23.49	19.29	27.87	3.97	7.80	30.10	116.14	31 of 35

Oil and Grease, Petroleum Hydrocarbons, and Surfactants (lbs/day)													Times		
	Jul	Aug	Sep	Oct	Nov	Dec	Jan	Feb	Mar	Apr	May	Jun	Average	Maximum	Detected
PETROLEUM HYDROCARBON	2088	905	1472	1256	816	751	983	1000	736	358	378	91	974	9003	76 of 76
TOTAL PETROLEUM HYDROCARBON	2602	2656	5272	4302	2523	2329	3208	22695	2491	1069	5198	374	4768	79216	74 of 79
FATS OIL AND GREASE	24500	23816	21976	22942	16826	18250	20411	37296	33450	9292	7390	2704	19896	90748	88 of 89
MBAS	5225	5244	5147	5107	3319	4385	4568	4194	5267	3673	1903	911	4182	6574	35 of 35

Table B-5 Nut Island Effluent Loadings, Fiscal Year 1998, cont.

Organochlorine Pesticides and PCBs (lbs/day)	Organochlorine Pesticides and PCBs (lbs/day)												Times		
	Jul	Aug	Sep	Oct	Nov	Dec	Jan	Feb	Mar	Apr	May	Jun	Average	Maximum	Detected
4,4'-DDD	0.002	0.002	0.002	0.001	0.001	0.002	0.002	0.002	0.004	0.002	0.001	0.0004	0.002	0.005	0 of 35
4,4'-DDE	0.002	0.002	0.004	0.001	0.001	0.002	0.002	0.002	0.004	0.002	0.003	0.0004	0.002	0.009	2 of 35
4,4'-DDT	0.002	0.002	0.002	0.001	0.001	0.002	0.002	0.002	0.004	0.002	0.001	0.0004	0.002	0.005	0 of 35
ALDRIN	0.002	0.002	0.002	0.001	0.001	0.002	0.002	0.002	0.004	0.002	0.001	0.0004	0.002	0.005	0 of 35
ALPHA-BHC	0.002	0.002	0.002	0.001	0.001	0.002	0.002	0.002	0.004	0.002	0.001	0.0004	0.002	0.005	0 of 35
ALPHA-CHLORDANE	0.002	0.002	0.002	0.001	0.001	0.002	0.002	0.002	0.004	0.002	0.004	0.0004	0.002	0.008	1 of 35
AROCLOR-1016	0.038	0.039	0.038	0.036	0.029	0.043	0.062	0.060	0.093	0.044	0.025	0.009	0.043	0.113	0 of 35
AROCLOR-1221	0.077	0.078	0.076	0.073	0.059	0.086	0.123	0.119	0.185	0.087	0.049	0.019	0.086	0.226	0 of 35
AROCLOR-1232	0.038	0.039	0.038	0.036	0.029	0.043	0.062	0.060	0.093	0.044	0.025	0.009	0.043	0.113	0 of 35
AROCLOR-1242	0.038	0.039	0.038	0.036	0.029	0.043	0.062	0.060	0.093	0.044	0.025	0.009	0.043	0.113	0 of 35
AROCLOR-1248	0.038	0.039	0.038	0.036	0.029	0.043	0.062	0.060	0.093	0.044	0.025	0.009	0.043	0.113	0 of 35
AROCLOR-1254	0.038	0.039	0.038	0.036	0.029	0.043	0.062	0.060	0.093	0.044	0.025	0.009	0.043	0.113	0 of 35
AROCLOR-1260	0.038	0.039	0.038	0.036	0.029	0.043	0.062	0.060	0.093	0.044	0.025	0.009	0.043	0.113	0 of 35
BETA-BHC	0.002	0.002	0.002	0.001	0.001	0.002	0.002	0.002	0.004	0.002	0.001	0.0004	0.002	0.005	0 of 35
CHLORDANE (TECHNICAL)	0.038	0.039	0.038	0.036	0.029	0.043	0.062	0.060	0.093	0.044	0.025	0.009	0.043	0.113	0 of 35
DELTA-BHC	0.002	0.002	0.002	0.001	0.001	0.002	0.002	0.002	0.004	0.002	0.001	0.0004	0.002	0.005	0 of 35
DIELDRIN	0.002	0.002	0.002	0.001	0.001	0.002	0.002	0.002	0.004	0.002	0.001	0.0004	0.002	0.005	0 of 35
ENDOSULFAN I	0.002	0.002	0.002	0.001	0.001	0.002	0.002	0.002	0.004	0.002	0.001	0.0004	0.002	0.005	0 of 35
ENDOSULFAN II	0.002	0.002	0.002	0.001	0.001	0.002	0.002	0.002	0.004	0.002	0.001	0.0004	0.002	0.005	0 of 35
ENDOSULFAN SULFATE	0.002	0.002	0.002	0.001	0.001	0.002	0.002	0.002	0.004	0.002	0.001	0.0004	0.002	0.005	0 of 35
ENDRIN	0.002	0.002	0.002	0.001	0.001	0.002	0.002	0.002	0.004	0.002	0.001	0.0004	0.002	0.005	0 of 35
ENDRIN ALDEHYDE	0.002	0.002	0.002	0.001	0.001	0.002	0.002	0.002	0.004	0.002	0.001	0.0004	0.002	0.005	0 of 35
ENDRIN KETONE	0.002	0.002	0.002	0.001	0.001	0.002	0.002	0.002	0.004	0.002	0.001	0.0004	0.002	0.005	0 of 35
GAMMA-BHC (LINDANE)	0.002	0.002	0.002	0.001	0.001	0.002	0.002	0.002	0.004	0.002	0.001	0.0004	0.002	0.005	0 of 35
GAMMA-CHLORDANE	0.002	0.002	0.002	0.001	0.001	0.002	0.002	0.002	0.004	0.006	0.005	0.0004	0.002	0.009	2 of 35
HEPTACHLOR	0.002	0.002	0.002	0.001	0.001	0.002	0.002	0.002	0.004	0.002	0.001	0.0004	0.002	0.005	0 of 35
HEPTACHLOR EPOXIDE	0.002	0.002	0.002	0.001	0.001	0.002	0.002	0.002	0.004	0.002	0.001	0.0004	0.002	0.005	0 of 35
METHOXYCHLOR	0.015	0.016	0.015	0.015	0.012	0.017	0.025	0.024	0.037	0.017	0.010	0.004	0.017	0.045	0 of 35
TOXAPHENE	0.038	0.039	0.038	0.036	0.029	0.043	0.062	0.060	0.093	0.044	0.025	0.009	0.043	0.113	0 of 35

Table B-5 Nut Island Effluent Loadings, Fiscal Year 1998, cont.

Semivolatile Organics (lbs/day)													Times		
	Jul	Aug	Sep	Oct	Nov	Dec	Jan	Feb	Mar	Apr	May	Jun	Average	Maximum	Detected
1,2,4-TRICHLOROBENZENE	0.75	0.76	0.77	0.73	0.58	0.86	1.61	1.17	1.83	0.88	0.48	0.20	0.89	2.21	0 of 35
1,2-DICHLOROBENZENE	0.75	0.76	0.77	0.73	0.58	0.86	1.61	1.17	1.83	0.88	0.48	0.20	0.89	2.21	0 of 35
1,2-DIPHENYLHYDRAZINE (AS AZOB)	0.75	0.76	0.77	0.73	0.58	0.86	1.61	1.17	1.83	0.88	0.48	0.20	0.89	2.21	0 of 35
1,3-DICHLOROBENZENE	0.75	0.76	0.77	0.73	0.58	0.86	1.61	1.17	1.83	0.88	0.48	0.20	0.89	2.21	0 of 35
1,4-DICHLOROBENZENE	0.75	0.76	0.77	0.73	0.58	0.86	1.61	1.17	1.83	0.88	0.48	0.20	0.89	2.21	0 of 35
2,2'-OXYBIS(1-CHLOROPROPANE)	0.75	0.76	0.77	0.73	0.58	0.86	1.61	1.17	1.83	0.88	0.48	0.20	0.89	2.21	0 of 35
2,4,5-TRICHLOROPHENOL	0.75	0.76	0.77	0.73	0.58	0.86	1.61	1.17	1.83	0.88	0.48	0.20	0.89	2.21	0 of 35
2,4,6-TRICHLOROPHENOL	0.75	0.76	0.77	0.73	0.58	0.86	1.61	1.17	1.83	0.88	0.48	0.20	0.89	2.21	0 of 35
2,4-DICHLOROPHENOL	0.75	0.76	0.77	0.73	0.58	0.86	1.61	1.17	1.83	0.88	0.48	0.20	0.89	2.21	0 of 35
2,4-DIMETHYLPHENOL	0.75	0.76	0.77	0.73	0.58	0.86	1.61	1.17	1.83	0.88	0.48	0.20	0.89	2.21	0 of 35
2,4-DINITROPHENOL	1.51	1.53	1.54	1.46	1.17	1.73	3.21	2.35	3.67	1.75	0.97	0.39	1.79	4.43	0 of 35
2,4-DINITROTOLUENE	0.75	0.76	0.77	0.73	0.58	0.86	1.61	1.17	1.83	0.88	0.48	0.20	0.89	2.21	0 of 35
2,6-DINITROTOLUENE	0.75	0.76	0.77	0.73	0.58	0.86	1.61	1.17	1.83	0.88	0.48	0.20	0.89	2.21	0 of 35
2-CHLORONAPHTHALENE	0.75	0.76	0.77	0.73	0.58	0.86	1.61	1.17	1.83	0.88	0.48	0.20	0.89	2.21	0 of 35
2-CHLOROPHENOL	0.75	0.76	0.77	0.73	0.58	0.86	1.61	1.17	1.83	0.88	0.48	0.20	0.89	2.21	0 of 35
2-METHYL-4,6-DINITROPHENOL	7.55	7.65	7.72	7.30	5.83	8.64	16.05	11.75	18.33	8.76	4.85	1.96	8.94	22.13	0 of 35
2-METHYLNAPHTHALENE	0.75	0.76	0.77	0.73	0.58	0.86	1.61	1.17	1.83	0.88	0.48	0.20	0.89	2.21	0 of 35
2-METHYLPHENOL	0.75	0.76	0.77	0.73	0.58	2.32	1.61	1.17	1.83	0.88	0.48	0.20	1.02	5.23	1 of 35
2-NITROANILINE	0.75	0.76	0.77	0.73	0.58	0.86	1.61	1.17	1.83	0.88	0.48	0.20	0.89	2.21	0 of 35
2-NITROPHENOL	0.75	0.76	0.77	0.73	0.58	0.86	1.61	1.17	1.83	0.88	0.48	0.20	0.89	2.21	0 of 35
3,3'-DICHLOROBENZIDINE	1.51	1.53	1.54	1.46	1.17	1.73	3.21	2.35	3.67	1.75	0.97	0.39	1.79	4.43	0 of 35
3-NITROANILINE	0.75	0.76	0.77	0.73	0.58	0.86	1.61	1.17	1.83	0.88	0.48	0.20	0.89	2.21	0 of 35
4-BROMOPHENYL PHENYL ETHER	0.75	0.76	0.77	0.73	0.58	0.86	1.61	1.17	1.83	0.88	0.48	0.20	0.89	2.21	0 of 35
4-CHLORO-3-METHYLPHENOL	0.75	0.76	0.77	0.73	0.58	0.86	1.61	1.17	1.83	0.88	0.48	0.20	0.89	2.21	0 of 35
4-CHLOROANILINE	0.75	0.76	0.77	0.73	0.58	0.86	1.61	1.17	1.83	0.88	0.48	0.20	0.89	2.21	0 of 35
4-CHLOROPHENYL PHENYL ETHER	0.75	0.76	0.77	0.73	0.58	0.86	1.61	1.17	1.83	0.88	0.48	0.20	0.89	2.21	0 of 35
4-METHYLPHENOL (INCLUDES 3-MET)	21.14	24.69	25.10	26.64	16.40	19.02	12.21	11.99	1.83	8.76	5.82	4.21	15.59	29.91	32 of 35
4-NITROANILINE	0.75	0.76	0.77	0.73	0.58	0.86	1.61	1.17	1.83	0.88	0.48	0.20	0.89	2.21	0 of 35
4-NITROPHENOL	1.51	1.53	1.54	1.46	1.17	1.73	3.21	2.35	3.67	1.75	0.97	0.39	1.79	4.43	0 of 35
ACENAPHTHENE	0.75	0.76	0.77	0.73	0.58	0.86	1.61	1.17	1.83	0.88	0.48	0.20	0.89	2.21	0 of 35
ACENAPHTHYLENE	0.75	0.76	0.77	0.73	0.58	0.86	1.61	1.17	1.83	0.88	0.48	0.20	0.89	2.21	0 of 35
ANILINE	0.75	0.76	0.77	0.73	0.58	0.86	1.61	1.17	1.83	0.88	0.48	0.20	0.89	2.21	0 of 35
ANTHRACENE	0.75	0.76	0.77	0.73	0.58	0.86	1.61	1.17	1.83	0.88	0.48	0.20	0.89	2.21	0 of 35
BENZIDINE	3.77	3.82	3.86	3.65	2.92	4.32	8.03	5.87	9.17	4.38	2.42	0.98	4.47	11.07	0 of 35
BENZO(A)ANTHRACENE	0.75	0.76	0.77	0.73	0.58	0.86	1.61	1.17	1.83	0.88	0.48	0.20	0.89	2.21	0 of 35
BENZO(A)PYRENE	0.75	0.76	0.77	0.73	0.58	0.86	1.61	1.17	1.83	0.88	0.48	0.20	0.89	2.21	0 of 35
BENZO(B)FLUORANTHENE	0.75	0.76	0.77	0.73	0.58	0.86	1.61	1.17	1.83	0.88	0.48	0.20	0.89	2.21	0 of 35
BENZO(GHI)PERYLENE	0.75	0.76	0.77	0.73	0.58	0.86	1.61	1.17	1.83	0.88	0.48	0.20	0.89	2.21	0 of 35
BENZO(K)FLUORANTHENE	0.75	0.76	0.77	0.73	0.58	0.86	1.61	1.17	1.83	0.88	0.48	0.20	0.89	2.21	0 of 35
BENZOIC ACID	33.61	19.19	10.95	9.10	24.44	1.73	13.84	16.82	9.88	15.48	5.35	1.64	13.55	38.53	19 of 35

Table B-5 Nut Island Effluent Loadings, Fiscal Year 1998, cont.

Semivolatile Organics (lbs/day)													Times		
	Jul	Aug	Sep	Oct	Nov	Dec	Jan	Feb	Mar	Apr	May	Jun	Average	Maximum	Detected
BENZYL ALCOHOL	6.80	7.28	8.31	10.62	6.83	17.90	13.21	9.52	4.82	3.31	1.82	1.44	8.03	25.81	29 of 35
BIS(2-CHLOROETHOXY)METHANE	0.75	0.76	0.77	0.73	0.58	0.86	1.61	1.17	1.83	0.88	0.48	0.20	0.89	2.21	0 of 35
BIS(2-CHLOROETHYL)ETHER	0.75	0.76	0.77	0.73	0.58	0.86	1.61	1.17	1.83	0.88	0.48	0.20	0.89	2.21	0 of 35
BIS(2-ETHYLHEXYL)PHTHALATE	3.56	3.41	3.54	1.43	2.70	3.00	1.61	1.17	1.83	0.88	0.48	0.20	2.04	7.30	10 of 35
BUTYL BENZYL PHTHALATE	0.75	0.76	0.77	0.73	0.58	0.86	1.61	1.17	1.83	0.88	0.48	0.20	0.89	2.21	0 of 35
CHRYSENE	0.75	0.76	0.77	0.73	0.58	0.86	1.61	1.17	1.83	0.88	0.48	0.20	0.89	2.21	0 of 35
DIBENZO(A,H)ANTHRACENE	0.75	0.76	0.77	0.73	0.58	0.86	1.61	1.17	1.83	0.88	0.48	0.20	0.89	2.21	0 of 35
DIBENZOFURAN	0.75	0.76	0.77	0.73	0.58	0.86	1.61	1.17	1.83	0.88	0.48	0.20	0.89	2.21	0 of 35
DIETHYL PHTHALATE	2.96	3.24	4.58	4.02	3.89	3.46	1.61	2.82	1.83	0.88	0.48	0.93	2.71	6.15	19 of 35
DIMETHYL PHTHALATE	0.75	0.76	0.77	0.73	0.58	0.86	1.61	1.17	1.83	0.88	0.48	0.20	0.89	2.21	0 of 35
DI-N-BUTYLPHthalate	0.75	0.76	0.77	0.73	0.58	0.86	1.61	1.17	1.83	0.88	0.48	0.20	0.89	2.21	0 of 35
DI-N-OCTYLPHthalate	0.75	0.76	0.77	0.73	0.58	0.86	1.61	1.17	1.83	0.88	0.48	0.20	0.89	2.21	0 of 35
FLUORANTHENE	0.75	0.76	0.77	0.73	0.58	0.86	1.61	1.17	1.83	0.88	0.48	0.20	0.89	2.21	0 of 35
FLUORENE	0.75	0.76	0.77	0.73	0.58	0.86	1.61	1.17	1.83	0.88	0.48	0.20	0.89	2.21	0 of 35
HEXACHLOROENZENE	0.75	0.76	0.77	0.73	0.58	0.86	1.61	1.17	1.83	0.88	0.48	0.20	0.89	2.21	0 of 35
HEXACHLOROBUTADIENE	0.75	0.76	0.77	0.73	0.58	0.86	1.61	1.17	1.83	0.88	0.48	0.20	0.89	2.21	0 of 35
HEXACHLOROCYCLOPENTADIENE	3.77	3.82	3.86	3.65	2.92	4.32	8.03	5.87	9.17	4.38	2.42	0.98	4.47	11.07	0 of 35
HEXACHLOROETHANE	0.75	0.76	0.77	0.73	0.58	0.86	1.61	1.17	1.83	0.88	0.48	0.20	0.89	2.21	0 of 35
INDENO(1,2,3-CD)PYRENE	0.75	0.76	0.77	0.73	0.58	0.86	1.61	1.17	1.83	0.88	0.48	0.20	0.89	2.21	0 of 35
ISOPHORONE	0.75	0.76	0.77	0.73	0.58	0.86	1.61	1.17	1.83	0.88	0.48	0.20	0.89	2.21	0 of 35
NAPHTHALENE	0.75	0.76	0.77	0.73	0.58	0.86	1.61	1.17	1.83	0.88	0.48	0.20	0.89	2.21	0 of 35
NITROBENZENE	0.75	0.76	0.77	0.73	0.58	0.86	1.61	1.17	1.83	0.88	0.48	0.20	0.89	2.21	0 of 35
N-NITROSODIMETHYLAMINE	0.75	0.76	0.77	0.73	0.58	0.86	1.61	1.17	1.83	0.88	0.48	0.20	0.89	2.21	0 of 35
N-NITROSODI-N-PROPYLAMINE	0.75	0.76	0.77	0.73	0.58	0.87	1.61	1.17	1.83	0.88	0.48	0.20	0.89	2.21	0 of 34
N-NITROSODIPHENYLAMINE	0.75	0.76	0.77	0.73	0.58	0.86	1.61	1.17	1.83	0.88	0.48	0.20	0.89	2.21	0 of 35
PENTACHLOROPHENOL	3.77	3.82	3.86	3.65	2.92	4.32	8.03	5.87	9.17	4.38	2.42	0.98	4.47	11.07	0 of 35
PHENANTHRENE	0.75	0.76	0.77	0.73	0.58	0.86	0.16	0.12	0.18	0.09	0.05	0.02	0.45	0.88	0 of 35
PHENOL	3.41	1.53	1.54	6.72	3.67	4.29	3.21	2.35	3.67	1.75	0.97	0.39	2.99	9.73	7 of 35
PYRENE	0.75	0.76	0.77	0.73	0.58	0.86	1.61	1.17	1.83	0.88	0.48	0.20	0.89	2.21	0 of 35

Table B-5 Nut Island Effluent Loadings, Fiscal Year 1998, cont.

Volatile Organics (lbs/day)													Times		
	Jul	Aug	Sep	Oct	Nov	Dec	Jan	Feb	Mar	Apr	May	Jun	Average	Maximum	Detected
1,1,1-TRICHLOROETHANE	0.40	0.35	0.38	0.35	0.34	0.41	1.46	0.57	0.84	0.29	0.22	0.05	0.47	2.97	1 of 36
1,1,2,2-TETRACHLOROETHANE	0.40	0.35	0.38	0.35	0.34	0.41	0.63	0.57	0.84	0.29	0.22	0.05	0.41	1.04	0 of 36
1,1,2-TRICHLOROETHANE	0.40	0.35	0.38	0.35	0.34	0.41	0.63	0.57	0.84	0.29	0.22	0.05	0.41	1.04	0 of 36
1,1-DICHLOROETHANE	0.40	0.35	0.38	0.35	0.34	0.41	0.63	0.57	0.84	0.29	0.22	0.05	0.41	1.04	0 of 36
1,1-DICHLOROETHENE	0.40	0.35	0.38	0.35	0.34	0.41	0.63	0.57	0.84	0.29	0.22	0.05	0.41	1.04	0 of 36
1,2-DICHLOROBENZENE	0.40	0.35	0.38	0.35	0.34	1.13	0.63	0.57	0.84	0.29	0.22	0.05	0.47	2.61	1 of 36
1,2-DICHLOROETHANE	0.40	0.35	0.38	0.35	0.34	0.41	0.63	0.57	0.84	0.29	0.22	0.05	0.41	1.04	0 of 36
1,2-DICHLOROPROPANE	0.40	0.35	0.38	0.35	0.34	0.41	0.63	0.57	0.84	0.29	0.22	0.05	0.41	1.04	0 of 36
1,3-DICHLOROBENZENE	0.40	0.51	0.38	0.35	0.34	1.11	0.63	0.57	0.84	0.29	0.22	0.05	0.48	2.54	2 of 36
1,4-DICHLOROBENZENE	1.37	1.22	2.21	1.67	0.34	1.50	0.63	0.57	0.84	0.29	0.22	0.05	0.95	3.69	14 of 36
2-BUTANONE	3.64	23.79	30.51	8.66	55.12	69.71	50.40	7.87	0.84	1.97	0.22	0.88	21.37	74.18	26 of 36
2-CHLOROETHYL VINYL ETHER	0.40	0.35	0.38	0.35	0.34	0.41	0.63	0.57	0.84	0.29	0.22	0.05	0.41	1.04	0 of 36
2-HEXANONE	0.40	0.35	0.38	0.35	0.34	0.41	0.63	0.57	0.84	0.29	0.22	0.05	0.41	1.04	0 of 36
4-METHYL-2-PENTANONE	0.40	0.35	0.38	0.35	0.34	0.41	0.63	0.57	0.84	0.29	0.22	0.05	0.41	1.04	0 of 36
ACETONE	137.49	111.50	132.07	124.80	99.82	113.56	101.13	157.10	195.20	72.83	48.75	12.70	111.03	268.40	36 of 36
ACROLEIN	0.40	0.35	0.38	0.35	0.34	0.41	0.63	0.57	0.84	0.29	0.22	0.05	0.41	1.04	0 of 36
ACRYLONITRILE	0.40	0.35	0.38	0.35	0.34	0.41	0.63	0.57	0.84	0.29	0.22	0.05	0.41	1.04	0 of 36
BENZENE	0.40	0.35	0.38	0.35	0.34	0.41	0.63	0.57	0.84	0.29	0.22	0.05	0.41	1.04	0 of 36
BROMODICHLOROMETHANE	1.81	0.71	1.17	0.81	0.34	0.41	0.63	0.57	0.84	0.29	0.22	0.05	0.67	2.45	10 of 36
BROMOFORM	0.40	0.35	0.38	0.35	0.34	0.41	0.63	0.57	0.84	0.29	0.22	0.05	0.41	1.04	0 of 36
BROMOMETHANE	0.40	0.35	0.38	0.35	0.34	0.41	0.63	0.57	0.84	0.29	0.22	0.05	0.41	1.04	0 of 36
CARBON DISULFIDE	1.24	1.80	1.19	1.01	0.34	1.32	0.63	0.57	0.84	0.29	0.22	0.05	0.81	3.12	13 of 36
CARBON TETRACHLORIDE	0.40	0.35	0.38	0.35	0.34	0.41	0.63	0.57	0.84	0.29	0.22	0.05	0.41	1.04	0 of 36
CHLOROBENZENE	0.40	0.35	0.38	0.35	0.34	0.41	0.63	0.57	0.84	0.29	0.22	0.05	0.41	1.04	0 of 36
CHLOROETHANE	0.40	0.35	0.38	0.35	0.34	0.41	0.63	0.57	0.84	0.29	0.22	0.05	0.41	1.04	0 of 36
CHLOROFORM	9.82	7.17	9.45	9.29	6.26	7.95	7.27	7.11	8.30	3.35	2.79	0.90	6.82	12.66	36 of 36
CHLOROMETHANE	0.61	0.97	1.10	1.35	0.34	0.41	0.63	0.57	0.84	0.29	0.22	0.05	0.65	3.25	7 of 36
CIS-1,2-DICHLOROETHENE	0.40	0.35	0.38	0.35	0.34	0.41	0.63	0.57	0.84	0.29	0.22	0.05	0.41	1.04	0 of 36
CIS-1,3-DICHLOROPROPENE	0.40	0.35	0.38	0.35	0.34	0.41	0.63	0.57	0.84	0.29	0.22	0.05	0.41	1.04	0 of 36
DIBROMOCHLOROMETHANE	0.40	0.35	0.38	0.35	0.34	0.41	0.63	0.57	0.84	0.29	0.22	0.05	0.41	1.04	0 of 36
ETHYLBENZENE	0.40	0.50	0.38	0.35	0.34	0.41	0.63	0.57	0.84	0.29	0.22	0.05	0.42	1.04	1 of 36
M,P-XYLENE	0.40	0.35	0.52	0.61	0.34	2.14	0.63	0.57	0.84	0.29	0.22	0.05	0.59	5.57	3 of 36
METHYLENE CHLORIDE	1.35	2.83	4.32	3.60	1.58	3.13	2.73	2.53	7.85	2.68	3.73	1.10	3.12	10.87	29 of 36
O-XYLENE	0.40	0.35	0.38	0.35	0.34	0.41	0.63	0.57	0.84	0.29	0.22	0.05	0.41	1.04	0 of 36

Table B-5 Nut Island Effluent Loadings, Fiscal Year 1998, cont.

Volatile Organics (lbs/day)													Times		
	Jul	Aug	Sep	Oct	Nov	Dec	Jan	Feb	Mar	Apr	May	Jun	Average	Maximum	Detected
STYRENE	0.40	0.35	0.38	0.35	0.34	<i>3.18</i>	0.63	0.57	0.84	0.29	0.22	0.05	0.64	8.75	1 of 36
TETRACHLOROETHENE	<i>1.50</i>	<i>1.20</i>	<i>2.96</i>	<i>3.33</i>	<i>4.14</i>	<i>3.85</i>	<i>5.60</i>	<i>9.61</i>	<i>7.09</i>	<i>5.45</i>	<i>2.67</i>	<i>0.49</i>	4.01	14.77	36 of 36
TOLUENE	<i>4.14</i>	<i>3.93</i>	<i>4.73</i>	<i>3.24</i>	<i>2.96</i>	<i>2.58</i>	<i>2.37</i>	<i>2.54</i>	0.84	0.29	0.22	<i>0.36</i>	2.43	7.48	24 of 36
TRANS-1,2-DICHLOROETHENE	0.40	0.35	0.38	0.35	0.34	0.41	0.63	0.57	0.84	0.29	0.22	0.05	0.41	1.04	0 of 36
TRANS-1,3-DICHLOROPROPENE	0.40	0.35	0.38	0.35	0.34	0.41	0.63	0.57	0.84	0.29	0.22	0.05	0.41	1.04	0 of 36
TRICHLOROETHENE	0.40	0.35	0.38	0.35	0.34	0.41	0.63	0.57	2.48	0.29	0.22	0.05	0.54	5.54	1 of 36
TRICHLOROFLUOROMETHANE	0.40	0.35	0.38	0.35	0.34	0.41	0.63	0.57	0.84	0.29	0.22	0.05	0.41	1.04	0 of 36
VINYL ACETATE	0.40	0.35	0.38	0.35	0.34	0.41	0.63	0.57	0.84	0.29	0.22	0.05	0.41	1.04	0 of 36
VINYL CHLORIDE	0.40	0.35	0.38	0.35	0.34	0.41	0.63	0.57	0.84	0.29	0.22	0.05	0.41	1.04	0 of 36

Notes:

Results in *bold italics* indicate one or more detects in the month.

Yearly averages are calculated from individual results collected in the fiscal year.

Non-detected compounds are assumed to equal one half of the detection limit for metals and inorganics and one tenth of the reporting limit for organic compounds.

During the months of April, May and June: If the monthly sample was collected on a day on which there were no discharges from Nut Island, an average daily flow for the month was used to calculate the load.

Appendix C

Table C-1 Cottage Farm CSO Facility Operations Summary, Fiscal Year 1998

Table C-2 Cottage Farm CSO Facility BOD and TSS Loadings, Fiscal Year 1998

Table C-3 Cottage Farm CSO Facility Effluent Characterization, Fiscal Year 1998

Table C-4 Cottage Farm CSO Facility Effluent Loadings, Fiscal Year 1998

Table C-1 Cottage Farm CSO Facility Operations Summary, Fiscal Year 1998

DATE	RAINFALL (inches)	DISCHARGE DURATION (hours)	TOTAL VOLUME (MG)	PH (su)	BOD		TSS		SETTL. SOLIDS (mL/L)	FECAL COLIFORM (col/100 ml)	CHLORINE RESIDUAL (mg/L)	
					INFLUENT (mg/L)	EFFLUENT (mg/L)	INFLUENT (mg/L)	EFFLUENT (mg/L)				
August	13	0.64	9.25	21.38	7.0	65	33	114	60	< 0.4	10	0.80
November	1	1.48	6.00	37.34	6.6	<18.4	56	216	92	1.6	60	2.42
	9	1.28	5.00	12.24	7.1	66	54	140	72	0.8	80	2.48
December	30	0.30	5.00	7.65	6.0*	62	69	92	104	2.0	300	2.20
January	24	1.53	16.00	49.92	7.0	95	41	130	80	1.6	60	
	**				6.9	76	31	58	62	1.4	40	2.90
	**				7.0	>103	39	64	28	1.0	< 10	
February	18	1.91	8.00	42.91	7.0	33	23	102	98	0.8	< 10	2.70
	24	2.28	16.00	43.39	7.0	86	32	2350	82	1.2	< 10	2.70
	**				6.8	58	52	60	48	1.0	< 10	2.70
March	9	2.14	11.25	21.95	7.0	94	13	112	12	< 0.2	< 10	2.89
	**				7.0	91	55	162	124	1.0	< 10	2.27
April	17	0.49	1.50	9.65	7.0	149	83	308	72	0.4	< 10	2.45
	20	0.66	0.50	0.76	~	~	~	~	~	~	~	~
	23	1.14	4.00	6.73	7.0	56	73	195	93	2.4	< 10	2.83
May	6	1.00	11.50	24.57	6.5	97	22	185	53	< 0.2	< 10	1.66
	**				6.8	91	38	266	34	< 0.2	< 10	2.67
	10	1.43	17.50	59.92	7.2	30	15	30	24	< 0.4	< 10	3.14
	**				7.0	45	41	60	46	0.4	10	2.58
	11	0.81	20.50	83.84	7.0	58	67	88	68	4.0	20	2.55
	**				7.0	62	55	74	52	2.0	< 10	1.87

Table C-1 Cottage Farm CSO Facility Operations Summary, Fiscal Year 1998

DATE	RAINFALL (inches)	DISCHARGE DURATION (hours)	TOTAL VOLUME (MG)	PH (su)	BOD		TSS		SETTL. SOLIDS (mL/L)	FECAL COLIFORM (col/100 ml)	CHLORINE RESIDUAL (mg/L)
					INFLUENT (mg/L)	EFFLUENT (mg/L)	INFLUENT (mg/L)	EFFLUENT (mg/L)			
June											
1	0.22	3.00	19.19	7.0	17	27	34	52	< 0.2	< 10	3.47
13	0.08	16.50	113.62	7.0	38	15	80	56	0.4	< 10	2.23
**					26	45	76	60	0.4	10	
14#	5.69	24.00	103.84	7.0	44	41	52	38	< 0.4	< 10	1.80
15#	1.17	24.00	54.67	6.5	>178	37	67	28	< 0.4	10	2.74
**				7.5	59	39	48	67	1.6	< 10	
16#	0.99	24.00	18.27	6.0	27	28	25	23	< 0.4	< 10	1.99
**				7.0	43	31	44	21	< 0.2	< 10	
17	0.26	7.00	9.82	7.0	43	43	19	14	< 0.2	10	1.89
18	0.13	19.50	5.02	7.0	61	51	110	64	0.2	< 10	2.1
30	1.67	8.00	45.63	7.0	38	69	83	84	1.6	10	2.64
TOTAL		258.00	792.31								
AVERAGE		11.73	36.01		91	43	176	58	0.9	14	2.43
MINIMUM		0.08	0.76	6.0	< 18.4	13	19	12	< 0.2	< 10	0.80
MAXIMUM		5.69	113.62	7.5	> 178	83	2350	124	4.0	300	3.47

No. of Times CSO Activated 19
 No. of Days CSO Activated 22

Continued from the previous day
 ** Multiple samples taken
 ~ No samples taken; station shut down upon arrival at the facility or short activation
 * Measurement suspect

Table C-2 Cottage Farm CSO Facility BOD and TSS Loadings, Fiscal Year 1998

DATE	TOTAL VOLUME (MG)	BOD		TSS	
		INFLUENT (lbs/d)	EFFLUENT (lbs/d)	INFLUENT (lbs/d)	EFFLUENT (lbs/d)
August					
13	21.38	11,590	5,866	20,327	10,699
November					
1	37.34	5,730	17,315	67,266	28,650
9	12.24	6,768	5,492	14,291	7,350
December					
30	7.65	3,924	4,377	5,870	6,635
January					
24	49.92	38,039	15,529	34,972	23,592
February					
18	42.91	11,667	8,124	36,503	35,071
24	43.39	26,055	15,199	436,056	23,522
March					
9	21.95	16,933	6,224	25,080	12,448
April					
17	9.65	11,992	6,640	24,788	5,795
20	0.66	~	~	~	~
23	6.73	3,160	4,103	10,945	5,220
May					
6	24.57	19,262	6,147	46,208	8,914
10	59.92	18,740	13,993	22,488	17,491
11	83.84	41,990	42,759	56,639	41,955

Table C-2 Cottage Farm CSO Facility BOD and TSS Loadings, Fiscal Year 1998

DATE	TOTAL VOLUME (MG)	BOD		TSS		
		INFLUENT (lbs/d)	EFFLUENT (lbs/d)	INFLUENT (lbs/d)	EFFLUENT (lbs/d)	
June						
1	19.19	2,737	4,289	5,442	8,322	
13	113.62	30,181	28,617	73,912	54,960	
14#	103.84	38,019	35,334	45,033	33,169	
15#	54.67	54,053	17,440	26,217	21,658	
16#	18.27	5,333	4,495	5,257	3,352	
17	9.82	3,546	3,505	1,556	1,147	
18	5.02	2,558	2,127	4,605	2,679	
30	45.63	14,461	26,220	31,586	31,967	
<hr/>						
TOTAL	792.21					
AVERAGE	36.01	17,464	13,038	47,383	18,314	
MINIMUM	0.66	2,558	2,127	1,556	1,147	
MAXIMUM	113.62	54,053	42,759	436,056	54,960	

No. of Times CSO Activated 19
 No. of Days CSO Activated 22

Continued from the previous day
 ~ No samples taken; station shut down upon arrival at the facility or short activation

Table C-3 Cottage Farm CSO Facility Effluent Characterization, Fiscal Year 1998

	Jul	Aug	Sep	Oct	Nov	Dec	Jan	Feb	Mar	Apr	May	Jun	AVG	MAX	Times Detected
Metals (ug/L)															
CADMIUM		<i>2.22</i>			1.00	1.00	1.00	1.00	<i>2.25</i>	1.00	<i>2.70</i>	1.00	1.40	2.70	3 of 9
COPPER		<i>127.00</i>			<i>92.90</i>	<i>62.60</i>	<i>61.20</i>	<i>39.70</i>	<i>97.80</i>	<i>79.20</i>	<i>19.80</i>	<i>63.40</i>	68.13	127.00	9 of 9
LEAD		<i>70.20</i>			<i>55.95</i>	<i>106.00</i>	<i>43.30</i>	<i>31.00</i>	<i>146.00</i>	<i>48.80</i>	<i>23.60</i>	<i>48.00</i>	55.01	146.00	10 of 10
MERCURY		<i>0.70</i>			<i>0.38</i>	<i>0.19</i>	<i>0.19</i>	<i>0.05</i>	<i>0.31</i>	<i>0.75</i>	<i>0.07</i>	<i>0.16</i>	0.26	0.75	10 of 10
NICKEL	N	<i>14.00</i>	N	N	4.00	4.00	4.00	4.00	4.00	4.00	4.00	4.00	4.92	14.00	1 of 9
ZINC	O	<i>197.00</i>	O	O	<i>132.00</i>	<i>200.00</i>	<i>111.00</i>	<i>75.00</i>	<i>161.00</i>	<i>132.00</i>	<i>39.30</i>	<i>117.00</i>	116.68	200.00	9 of 9
Cyanide and Phenols (mg/L)															
CYANIDE	C	5.00	C	C	5.00	5.00	<i>14.80</i>	<i>15.30</i>	5.00	<i>13.00</i>	<i>15.10</i>	5.00	10.40	15.30	4 of 9
PHENOL	T	1.00	T	T	1.00	1.00	1.00	<i>14.50</i>	1.00	1.00	1.00	1.00	3.49	14.50	1 of 9
Surfactants (mg/L)															
SURFACTANTS	A	<i>3.46</i>	A	A	<i>2.21</i>	<i>0.169</i>	<i>0.672</i>	<i>0.809</i>	3.37	<i>2.15</i>	<i>1.46</i>	<i>1.19</i>	1.604	3.46	9 of 9
Organochlorine Pesticides and PCBs (ug/L)															
4,4'-DDD	O	0.002	O	O	<i>0.010</i>	0.004	0.002	<i>0.016</i>	0.002	0.002	0.002	0.002	0.006	0.016	2 of 9
4,4'-DDE	N	0.002	N	N	<i>0.010</i>	0.004	0.002	<i>0.015</i>	0.002	0.002	0.002	0.002	0.006	0.015	2 of 9
4,4'-DDT	S	0.002	S	S	0.002	0.004	0.002	<i>0.031</i>	0.002	0.002	0.002	0.002	0.007	0.031	1 of 9
METHOXYCHLOR		0.021			0.021	0.040	0.020	0.024	<i>0.148</i>	0.021	0.021	0.022	0.033	0.148	1 of 9
Semivolatile Organics (ug/L)															
4-METHYLPHENOL (INCLUDES 3-MET)		1.23			1.10	1.03	1.02	1.07	1.05	1.04	<i>5.13</i>	1.23	1.52	5.13	1 of 9
BENZOIC ACID		2.46			2.20	2.06	2.04	2.14	2.10	<i>18.10</i>	2.02	2.46	2.83	18.10	1 of 9
BENZYL ALCOHOL		1.23			1.10	<i>10.09</i>	1.02	1.07	1.05	1.04	1.01	1.23	1.38	10.09	1 of 9
BIS(2-ETHYLHEXYL)PHTHALATE		<i>13.80</i>			<i>10.10</i>	<i>7.52</i>	1.02	<i>12.19</i>	<i>6.03</i>	<i>9.24</i>	1.01	<i>7.26</i>	7.21	13.80	7 of 9
FLUORANTHENE		1.23			1.10	1.03	1.02	<i>6.84</i>	1.05	1.04	1.01	1.23	2.15	6.84	1 of 9
PHENANTHRENE		1.23			1.10	0.10	0.10	<i>4.55</i>	0.11	0.10	0.10	<i>1.70</i>	1.32	4.55	2 of 9

Results in *bold italics* indicate one or more detects in the month.

Yearly averages are calculated from individual results collected in the fiscal year.

Non-detected compounds are assumed to equal one half of the detection limit for metals and inorganics and one tenth of the reporting limit for organic compounds.

Table C-4 Cottage Farm CSO Facility Effluent Loadings, Fiscal Year 1998

	Jul	Aug	Sep	Oct	Nov	Dec	Jan	Feb	Mar	Apr	May	Jun	AVG	MAX	Times Detected
Metals (lbs/day)															
CADMIUM		<i>0.40</i>			0.31	0.06	0.42	0.36	<i>0.38</i>	0.08	<i>0.55</i>	0.16	0.30	0.55	3 of 9
COPPER		<i>22.66</i>			<i>28.92</i>	<i>4.00</i>	<i>25.50</i>	<i>14.22</i>	<i>16.43</i>	<i>6.38</i>	<i>4.06</i>	<i>10.15</i>	14.70	28.92	9 of 9
LEAD		<i>12.53</i>			<i>17.42</i>	<i>6.77</i>	<i>18.04</i>	<i>11.10</i>	<i>24.53</i>	<i>3.93</i>	<i>4.84</i>	<i>7.69</i>	11.87	24.53	10 of 10
MERCURY		<i>0.12</i>			<i>0.12</i>	<i>0.01</i>	<i>0.08</i>	<i>0.02</i>	<i>0.05</i>	<i>0.06</i>	<i>0.01</i>	<i>0.03</i>	0.06	0.12	10 of 10
NICKEL	N	<i>2.50</i>	N	N	1.25	0.26	1.67	1.43	0.67	0.32	0.82	0.64	1.06	2.50	1 of 9
ZINC	O	<i>35.15</i>	O	O	<i>41.09</i>	<i>12.77</i>	<i>46.24</i>	<i>26.86</i>	<i>27.05</i>	<i>10.63</i>	<i>8.06</i>	<i>18.74</i>	25.17	46.24	9 of 9
Cyanide and Phenols (lbs/day)															
CYANIDE	A		A	A											
PHENOL	C	0.89	C	C	1.56	0.32	<i>6.17</i>	<i>5.48</i>	0.84	<i>1.05</i>	<i>3.10</i>	0.80	2.24	6.17	4 of 9
	T	0.18	T	T	0.31	0.06	0.42	<i>5.19</i>	0.17	0.08	0.21	0.16	0.75	5.19	1 of 9
	I		I	I											
Surfactants (lbs/day)															
SURFACTANTS	V		V	V											
	A	<i>617.33</i>	A	A	<i>687.92</i>	<i>10.789</i>	<i>279.95</i>	<i>289.7</i>	<i>566.12</i>	<i>173.14</i>	<i>299.36</i>	<i>190.57</i>	346.1	687.92	9 of 9
	T		T	T											
Organochlorine Pesticides and PCBs (lbs/day)															
4,4'-DDD	I		I	I											
	O	0.000	O	O	<i>0.003</i>	0.000	0.001	<i>0.006</i>	0.000	0.000	0.000	0.000	0.001	0.006	2 of 9
4,4'-DDE	N	0.000	N	N	<i>0.003</i>	0.000	0.001	<i>0.005</i>	0.000	0.000	0.000	0.000	0.001	0.005	2 of 9
4,4'-DDT	S	0.000	S	S	0.001	0.000	0.001	<i>0.011</i>	0.000	0.000	0.000	0.000	0.002	0.011	1 of 9
METHOXYCHLOR		0.004			0.007	0.003	0.008	0.009	<i>0.025</i>	0.002	0.004	0.003	0.007	0.025	1 of 9
Semivolatile Organics (lbs/day)															
4-METHYLPHENOL (INCLUDES 3-MET)		0.22			0.34	0.07	0.42	0.38	0.18	0.08	<i>1.05</i>	0.20	0.33	1.05	1 of 9
BENZOIC ACID		0.44			0.68	0.13	0.85	0.77	0.35	<i>1.46</i>	0.41	0.39	0.61	1.46	1 of 9
BENZYL ALCOHOL		0.22			0.34	<i>0.64</i>	0.42	0.38	0.18	0.08	0.21	0.20	0.30	0.64	1 of 9
BIS(2-ETHYLHEXYL)PHTHALATE		<i>2.46</i>			<i>3.14</i>	<i>0.48</i>	0.42	<i>4.37</i>	<i>1.01</i>	<i>0.74</i>	0.21	<i>1.16</i>	1.56	4.37	7 of 9
FLUORANTHENE		0.22			0.34	0.07	0.42	<i>2.45</i>	0.18	0.08	0.21	0.20	0.46	2.45	1 of 9
PHENANTHRENE		0.22			0.34	0.01	0.04	<i>1.63</i>	0.02	0.01	0.02	<i>0.27</i>	0.28	1.63	2 of 9

Results in *bold italics* indicate one or more detects in the month.

Appendix D

Table D-1 Prison Point CSO Facility Operations Summary, Fiscal Year 1998

Table D-2 Prison Point CSO Facility BOD and TSS Loadings, Fiscal Year 1998

Table D-3 Prison Point CSO Facility Effluent Characterization, Fiscal Year 1998

Table D-4 Prison Point CSO Facility Effluent Loadings, Fiscal Year 1998

Table D-1 Prison Point CSO Facility Operations Summary, Fiscal Year 1998

DATE	RAINFALL (inches)	DISCHARGE DURATION (hours)	TOTAL VOLUME (MG)	PH (su)	BOD		TSS		SETTL. SOLIDS (mL/L)	FECAL COLIFORM (col/100 ml)	CHLORINE RESIDUAL (mg/L)	
					INFLUENT (mg/L)	EFFLUENT (mg/L)	INFLUENT (mg/L)	EFFLUENT (mg/L)				
August												
	3	0.44	10.00	10.00	6.8	116	74	408	160	1.2	< 10	1.6
	13	0.64	6.00	14.00	7.2	82.2	42.5	302	150	1.6	< 10	1.7
	21	0.85	3.00	5.00	6.8	52.3	29.8	514	40	< 0.4	20	1.8
September												
	20	0.40	0.50	2.60	6.9	67.7	55	295	78	< 0.2	20	1.7
October												
	25	0.68	2.00	2.50	6.9	88.2	43.1	513	90	0.6	100	1.3
	27	0.59	3.50	7.50	7.0	< 46.5	32.2	336	72	0.4	< 10	1.8
November												
	1	1.48	8.50	42.00	6.9	83.5	50.1	136	46	< 0.4	10	1.9
	8	0.69	1.75	3.50	6.8	< 11.1	16.8	32	37	< 0.2	< 10	2.3
	9	1.28	7.50	30.00	6.9	32.2	20.8	157	125	0.8	110	1.4
	22	0.79	6.00	11.80	7.5	37.1	39.1	84	50	< 0.2	< 10	2.0
December												
	30	0.30	4.75	11.80	6.9	125	35.9	370	136	1.2	< 10	2.5
January												
	8	0.46	6.00	6.88	6.9	116	16.8	348	44	0.2	10	2.0
	9	0.30	3.00	2.50	6.9	85.8	37.8	136	52	< 0.4	170	2.3
	24	1.53	11.00	65.00	6.9	24	17.2	86	70	0.3	< 10	1.8
February												
	12	0.77	3.50	8.00	6.9	35.3	28.8	116	74	< 0.4	10	2.1
	18	1.91	10.75	76.30	6.7	40.4	34.4	120	200	1.2	< 10	1.8
	24	2.28	18.50	74.13	7.1	36.2	20	140	110	0.8	< 10	2.3
	**				7.2	40.5	26.5	180	32	< 0.2	< 10	2.3
March												
	1	0.13	1.75	3.00	7.2	25.5	30.9	24	28	< 0.21	< 2	ND
	9	2.14	18.50	54.00	7.2	< 12.4	34.5	41	109	3.0	20	2.3
	**				7.2	< 18.9	55	16	77	0.6	< 10	2.2
	19	1.08	11.50	8.20	7.2	52.1	37.4	254	58	0.4	30	2.6
	**				7.2	32.9	42.9	164	28	< 0.2	< 10	1.9

Table D-1 Prison Point CSO Facility Operations Summary, Fiscal Year 1998

DATE	RAINFALL (inches)	DISCHARGE DURATION (hours)	TOTAL VOLUME (MG)	PH (su)	BOD		TSS		SETTL. SOLIDS (mL/L)	FECAL COLIFORM (col/100 ml)	CHLORINE RESIDUAL (mg/L)
					INFLUENT (mg/L)	EFFLUENT (mg/L)	INFLUENT (mg/L)	EFFLUENT (mg/L)			
April											
17	0.49	2.50	4.50	7.1	99.5	61.3	200	154	1.8	< 10	2.0
20	0.66	5.50	19.50	7.3	42.2	30.9	170	132	1.2	< 10	2.4
23	1.14	8.50	31.00	7.3	23.2	33.6	126	70	0.4	1400	2.6
May											
2	0.47	3.00	2.73	7.2	129	46.5	214	52	< 0.2	< 10	1.3
6	1.00	9.50	36.50	7.2	79	56.1	318	143	2.0	80	1.7
**				7.2	71.4	27.2	186	235	1.0	10	2.7
7	1.50	4.50	12.25	7.3	< 21.7	< 21.7	118	86	0.4	40	1.8
10	1.43	14.00	26.50	7.3	< 9.7	21.7	60	128	1.2	60	1.5
**				7.2	24.7	21	40	26	< 0.4	10	1.9
11#	0.81	9.00	18.75	7.5	< 26.8	42.4	60	22	< 0.4	30	1.4
June											
1	0.22	5.00	12.00	7.2	42.8	39.7	100	62	0.4	< 10	3.1
7	0.15	2.00	2.00	~	~	~	~	~	~	~	~
13	0.08	21.00	142.63	7.2	14.8	32.9	38	56	< 0.2	40	1.3
**					13.2	18.4	94	76	< 0.2	< 10	1.3
14#	5.69	17.00	131.63	7.2	25.8	20.9	35	23	< 0.4	< 10	1.2
15	1.17	7.00	33.75	7.0	37.4	33.2	869	68	0.8	< 10	1.9
30	1.67	9.00	45.55	7.2	43.1	31.4	103	28	< 0.2	80	2.1
TOTAL		255.50	957.99								
AVERAGE		7.51	28.18		50.41	36.73	198.95	84.14	0.67	18.44	1.94
MINIMUM		0.08	2.00	6.70	< 9.7	16.80	16.00	22.00	< 0.2	< 10	1.16
MAXIMUM		5.69	21.00	7.50	129.00	74.00	869.00	235.00	3.00	1400.00	3.10

No. of TIMES CSO ACTIVATED 32
 No. of DAYS CSO ACTIVATED 34

Continued from the previous day
 ** Multiple samples taken
 ~ No samples taken due to short activation
 ND = No data

Table D-2 Prison Point CSO Facility TSS and BOD Loadings, Fiscal Year 1998

DATE	TOTAL VOLUME (MG)	BOD		TSS	
		INFLUENT (lbs/d)	EFFLUENT (lbs/d)	INFLUENT (lbs/d)	EFFLUENT (lbs/d)
August					
3	10.00	9,674	6,172	34,027	13,344
13	14.00	9,598	4,962	35,262	17,514
21	5.00	2,181	1,243	21,434	1,668
September					
20	2.60	1,468	1,193	6,397	1,691
October					
25	2.50	1,839	899	10,696	1,877
27	7.50	2,909	2,014	21,017	4,504
November					
1	42.00	29,248	17,549	47,638	16,113
8	3.50	324	490	934	1,080
9	30.00	8,056	5,204	39,281	31,275
22	11.80	3,651	3,848	8,267	4,921
December					
30	11.80	12,302	3,533	36,412	13,384
January					
8	6.88	6,656	964	19,968	2,525
9	2.50	1,789	788	2,836	1,084
24	65.00	13,010	9,324	46,621	37,947
February					
12	8.00	2,355	1,922	7,740	4,937
18	76.30	25,708	21,890	76,361	127,268
24	74.13	22,380	14,374	98,919	43,895
March					
1	3.00	638	773	600	701
9	54.00	7,048	20,154	12,835	41,883
19	8.20	2,906	2,746	14,293	2,941

Table D-3 Prison Point CSO Facility Effluent Characterization, Fiscal Year 1998

	Jul	Aug	Sep	Oct	Nov	Dec	Jan	Feb	Mar	Apr	May	Jun	AVG	MAX	Times Detected
Metals (ug/L)															
CADMIUM		<i>3.02</i>		1.00	1.00	1.00	1.00	1.00	1.00	1.00	1.00	1.00	1.08	3.02	1 of 10
COPPER		<i>139.00</i>		<i>61.80</i>	<i>73.20</i>	<i>57.20</i>	<i>42.20</i>	<i>52.30</i>	<i>43.00</i>	<i>85.90</i>	<i>116.00</i>	<i>42.00</i>	61.52	139.00	10 of 10
LEAD		<i>210.00</i>		<i>108.00</i>	<i>101.00</i>	<i>83.40</i>	<i>62.00</i>	<i>98.80</i>	<i>48.70</i>	<i>149.00</i>	<i>269.00</i>	<i>51.50</i>	95.95	269.00	10 of 10
MERCURY		<i>0.44</i>	N	<i>0.22</i>	<i>0.59</i>	<i>0.21</i>	<i>0.20</i>	<i>0.21</i>	<i>0.06</i>	<i>0.31</i>	<i>0.49</i>	<i>0.09</i>	0.23	0.59	10 of 10
NICKEL	N	<i>12.40</i>	O	<i>11.20</i>	<i>11.00</i>	4.00	4.00	4.00	4.00	4.00	<i>15.80</i>	4.00	6.61	15.80	4 of 10
ZINC	O	<i>324.00</i>		<i>175.00</i>	<i>192.00</i>	<i>182.00</i>	<i>112.00</i>	<i>176.00</i>	<i>103.00</i>	<i>214.00</i>	<i>330.00</i>	<i>109.00</i>	162.09	330.00	10 of 10
Cyanide and Phenols (mg/L)															
CYANIDE	A		A												
PHENOL	C	ND	M	<i>11.50</i>	<i>12.00</i>	ND	<i>29.30</i>	<i>22.30</i>	5.00	<i>19.30</i>	<i>17.20</i>	5.00	9.33	29.30	6 of 9
	T	<i>16.30</i>	P	<i>15.90</i>	1.00	1.00	1.00	<i>10.00</i>	1.00	<i>16.20</i>	1.00	<i>12.10</i>	7.64	16.30	5 of 10
Surfactants (mg/L)															
SURFACTANTS	I		L												
	V		E												
	A	<i>1.56</i>	S	<i>0.68</i>	<i>0.88</i>	<i>0.43</i>	<i>1.65</i>	<i>0.65</i>	<i>0.30</i>	<i>0.82</i>	<i>0.85</i>	<i>0.79</i>	0.76	1.65	10 of 10
Organochlorine Pesticides and PCBs (ug/L)															
4,4'-DDD	I		T												
	O	0.002	A	0.002	<i>0.011</i>	0.002	0.003	0.002	0.002	0.002	0.002	0.002	0.003	0.011	1 of 10
Semivolatile Organics (ug/L)															
BIS(2-ETHYLHEXYL)PHTHALATE	N		E												
		<i>8.07</i>	N	<i>12.00</i>	<i>12.40</i>	<i>11.19</i>	<i>7.70</i>	<i>9.94</i>	1.05	<i>9.05</i>	1.11	1.06	4.12	12.40	7 of 10
FLUORANTHENE		1.08		1.20	1.12	1.08	1.15	<i>7.80</i>	1.05	1.04	1.11	1.06	1.23	7.80	1 of 10
PHENANTHRENE		1.08		1.20	1.12	<i>2.80</i>	<i>2.03</i>	<i>4.32</i>	0.11	<i>2.28</i>	0.11	0.11	0.65	4.32	4 of 10

ND - No Data

Results in *bold italics* indicate one or more detects in the month.

Yearly averages are calculated from individual results collected in the fiscal year.

Non-detected compounds are assumed to equal one half of the detection limit for metals and inorganics and one tenth of the reporting limit for organic compounds.

Table D-4 Prison Point CSO Facility Effluent Loadings, Fiscal Year 1998

	Jul	Aug	Sep	Oct	Nov	Dec	Jan	Feb	Mar	Apr	May	Jun	AVG	MAX	Times Detected
Metals (lbs/day)															
CADMIUM		<i>0.35</i>		0.06	0.35	0.10	0.06	0.07	0.45	0.16	0.30	1.19	0.31	1.19	1 of 10
COPPER		<i>16.24</i>		<i>3.87</i>	<i>25.66</i>	<i>5.63</i>	<i>2.42</i>	<i>3.49</i>	<i>19.38</i>	<i>13.98</i>	<i>35.33</i>	<i>49.99</i>	17.60	49.99	10 of 10
LEAD		<i>24.53</i>		<i>6.76</i>	<i>35.40</i>	<i>8.21</i>	<i>3.56</i>	<i>6.60</i>	<i>21.95</i>	<i>24.25</i>	<i>81.94</i>	<i>61.30</i>	27.45	81.94	10 of 10
MERCURY		<i>0.05</i>	N	<i>0.01</i>	<i>0.21</i>	<i>0.02</i>	<i>0.01</i>	<i>0.01</i>	<i>0.03</i>	<i>0.05</i>	<i>0.15</i>	<i>0.11</i>	0.07	0.21	10 of 10
NICKEL	N	<i>1.45</i>	O	<i>0.70</i>	<i>3.86</i>	0.39	0.23	0.27	1.80	0.65	<i>4.81</i>	4.76	1.89	4.81	4 of 10
ZINC	O	<i>37.85</i>		<i>10.95</i>	<i>67.30</i>	<i>17.92</i>	<i>6.43</i>	<i>11.75</i>	<i>46.42</i>	<i>34.82</i>	<i>100.52</i>	<i>129.74</i>	46.37	129.74	10 of 10
Cyanide and Phenols (lbs/day)															
CYANIDE	A		A												
PHENOL	C	ND	M	<i>0.72</i>	<i>4.21</i>	ND	<i>1.68</i>	<i>1.49</i>	2.25	<i>3.14</i>	<i>5.24</i>	5.95	3.09	5.95	6 of 9
	T	<i>1.90</i>	P	<i>1.00</i>	0.35	0.10	0.06	<i>0.67</i>	0.45	<i>2.64</i>	0.30	<i>14.40</i>	2.19	14.40	5 of 10
Surfactants (lbs/day)															
SURFACTANTS	I		L												
	V		E												
	A	<i>182.26</i>	S	<i>42.56</i>	<i>307.04</i>	<i>42.54</i>	<i>94.73</i>	<i>43.19</i>	<i>134.74</i>	<i>133.60</i>	<i>259.82</i>	<i>940.31</i>	218.08	940.31	10 of 10
Organochlorine Pesticides and PCBs (lbs/day)															
4,4'-DDD	I		T												
	O	0.0003	A	0.0002	<i>0.0040</i>	0.0002	0.0002	0.0001	0.0010	0.0003	0.0006	0.0024	0.0009	0.0040	1 of 10
Semivolatile Organics (lbs/day)															
BIS(2-ETHYLHEXYL)PHTHALATE	S		E												
		<i>0.94</i>	N	<i>0.75</i>	<i>4.35</i>	<i>1.10</i>	<i>0.44</i>	<i>0.66</i>	0.47	<i>1.47</i>	0.34	1.26	1.18	4.35	7 of 10
FLUORANTHENE		0.13		0.08	0.39	0.11	0.07	<i>0.52</i>	0.47	0.17	0.34	1.26	0.35	1.26	1 of 10
PHENANTHRENE		0.13		0.08	0.39	<i>0.28</i>	<i>0.12</i>	<i>0.29</i>	0.05	<i>0.37</i>	0.03	0.13	0.19	0.39	4 of 10

ND- No Data

Results in *bold italics* indicate one or more detects in the month.

Appendix E

- Table E-1 Somerville Marginal CSO Facility Operations Summary, FY 1998
- Table E-2 Somerville Marginal CSO Facility BOD and TSS Loadings, FY 1998
- Table E-3 Somerville Marginal CSO Facility Effluent Characterization, FY 1998
- Table E-4 Somerville Marginal CSO Facility Effluent Loadings, FY 1998

Table E-1 Somerville Marginal CSO Facility Operations Summary, Fiscal Year 1998

DATE	RAINFALL (inches)	DISCHARGE DURATION (hours)	TOTAL VOLUME (MG)	PH (su)	BOD		TSS		SETTL. SOLIDS (mL/L)	FECAL COLIFORM (col/100 ml)	CHLORINE RESIDUAL (mg/L)	
					INFLUENT (mg/L)	EFFLUENT (mg/L)	INFLUENT (mg/L)	EFFLUENT (mg/L)				
August												
	3	0.44	2.75	1.44	6.8	41	33	130	206	1.2	< 10	3.8
	13	0.64	4.50	2.89	7.0	53	10	90	82	< 0.4	< 10	1.8
	21	0.85	1.50	1.14	7.2	76	18	96	94	0.8	< 10	3.9
September												
	12	0.26	3.00	0.61	7.0	45	< 9.4	84	41	0.4	< 10	3.4
	20	0.40	0.25	~	~	~	~	~	~	~	~	~
November												
	1	1.48	11.00	7.02	6.8	46	49	66	104	2.0	< 10	3.3
	9	1.28	6.75	4.05	6.8	32	17	80	89	0.8	130	3.2
December												
	30	0.30	7.00	2.41	6.8	< 14.9	7	40	34	< 0.4	< 10	2.7
January												
	7	0.71	0.50	0.55	~	~	~	~	~	~	~	~
	8	0.46	3.00	0.09	~	~	~	~	~	~	~	~
	23	0.73	16.50	11.78	~	40	16	134	62	0.2	< 10	4.5
February												
	12	0.77	5.00	1.40	6.8	< 12.7	14	25	98	1.2	< 10	4.0
	18	1.91	13.75	12.56	6.8	< 6.47	< 12.9	56	62	< 0.4	< 10	2.7
	24	2.28	20.25	8.50	6.8	17	20	50	108	3.8	< 10	4.1
	**				6.8	22	11	30	26	< 0.2	< 10	
March												
	9	2.14	21.50	6.04	7.1	25	10	73	39	< 0.2	< 10	2.5
	**				7.1	21	43	82	164	4.0	10	3.3
	19	1.08	5.50	0.64	6.8	< 11.5	41	32	122	1.5	60	3.7
April												
	17	0.49	0.25	0.35	~	~	~	~	~	~	~	~
	20	0.66	9.00	0.51	7.0	16	12	60	56	< 0.4	< 10	3.8
	23	1.14	10.00	1.56	6.8	17	27	80	88	1.2	20	2.7

Table E-2 Somerville Marginal CSO BOD and TSS Loadings, Fiscal Year 1998

DATE	TOTAL VOLUME (MG)	BOD		TSS		
		INFLUENT (lbs/d)	EFFLUENT (lbs/d)	INFLUENT (lbs/d)	EFFLUENT (lbs/d)	
August						
3	1.44	492	392	1,561	2,474	
13	2.89	1,273	234	2,169	1,976	
21	1.14	722	174	913	894	
September						
12	0.61	229	48	430	210	
20	~	~	~	~	~	
November						
1	7.02	2,693	2,892	3,864	6,089	
9	4.05	1,077	564	2,702	3,006	
December						
30	2.41	299	143	804	683	
January						
7	0.55	~	~	~	~	
8	0.09	~	~	~	~	
23	11.78	3,959	1,592	13,165	6,091	
February						
12	1.40	149	168	293	1,147	
18	12.56	678	1,351	5,866	6,494	
24	8.50	1,382	1,098	2,834	4,747	
March						
9	6.04	1,159	1,335	3,904	5,113	
19	0.64	61	219	171	651	
April						
17	0.35	~	~	~	~	
20	0.51	68	51	255	238	
23	1.56	219	350	1,041	1,145	

Table E-2 Somerville Marginal CSO BOD and TSS Loadings, Fiscal Year 1998

DATE	TOTAL VOLUME (MG)	BOD		TSS		
		INFLUENT (lbs/d)	EFFLUENT (lbs/d)	INFLUENT (lbs/d)	EFFLUENT (lbs/d)	
May						
2	0.11	~	~	~	~	
6	3.82	408	848	3,189	7,782	
7	1.36	~	~	~	~	
10	3.14	429	254	1,152	1,100	
11	3.08	659	328	1,488	770	
June						
1	1.51	317	208	2,393	441	
3	0.70	~	~	~	~	
7	1.86	~	~	~	~	
13	20.17	2,557	1,985	6,392	5,047	
14#	21.72	2,101	1,848	7,608	3,261	
15#	4.18	830	526	3,486	1,534	
30	2.63	719	640	1,448	1,711	
<hr/>						
TOTAL	127.81					
AVERAGE	4.12	977	750	2,919	2,722	
MINIMUM	0.09	61	48	171	210	
MAXIMUM	21.72	3,959	2,892	13,165	7,782	

No. of TIMES CSO ACTIVATED 30

No. of DAYS CSO ACTIVATED 31

Continued from previous day

~ No samples taken; short activation

Table E-3 Somerville Marginal CSO Facility Effluent Characterization, Fiscal Year 1998

	Jul	Aug	Sep	Oct	Nov	Dec	Jan	Feb	Mar	Apr	May	Jun	MIN	AVG	MAX	Times Detected
Metals (ug/L)																
CADMIUM		1.00			10.00	1.00		1.00	1.00	1.00	1.00	1.00	1.00	2.42	10.00	0 of 9
COPPER		28.20	N		437.00	35.50	N	64.50	25.10	24.80	23.70	27.50	23.70	93.22	437.00	9 of 9
LEAD	N	22.10	O	N	145.00	36.30	O	107.00	75.30	31.70	28.40	30.80	22.10	57.27	145.00	9 of 10
MERCURY	O	0.09		O	0.22	0.03		0.42	0.13	0.06	0.10	0.47	0.03	0.30	0.47	7 of 9
NICKEL		13.10	S		40.00	4.00	S	10.90	4.00	4.00	4.00	4.00	4.00	10.15	40.00	2 of 9
ZINC	A	120.00	A	A	286.00	119.00	A	283.00	91.90	94.40	89.30	106.00	89.30	137.64	286.00	9 of 9
	C		M	C			M									
Cyanide and Phenols (mg/L)																
	T		P	T			P									
CYANIDE	I	5.00	L	I	5.00	27.60	L	5.00	5.00	5.00	5.00	5.00	5.00	6.23	27.60	1 of 9
PHENOL	V	1.00	E	V	1.00	18.50	E	1.00	18.30	1.00	1.00	1.00	1.00	4.31	18.50	2 of 9
	A		S	A			S									
Surfactants (mg/L)																
	T			T												
SURFACTANTS	I	1.02	T	I	1.24	0.167	T	ND	0.777	0.693	1.27	1.64	0.17	1.2934	1.64	8 of 8
	O		A	O			A									
Semivolatile Organics (ug/L)																
	N		K	N			K									
BIS(2-ETHYLHEXYL)PHTHALATE	S	1.12	E	S	11.30	1.04	E	10.24	1.15	1.00	1.12	1.15	1.00	3.03	11.30	2 of 9
PHENANTHRENE		1.12	N		1.28	0.10	N	2.29	0.12	0.10	0.11	0.12	0.10	0.39	2.29	1 of 9

ND - No Data

Results in **bold italics** indicate one or more detects in the month.

Yearly averages are calculated from individual results collected in the fiscal year.

Non-detected compounds are assumed to equal one half of the detection limit for metals and inorganics and one tenth of the reporting limit for organic compounds.

Table E-4 Somerville Marginal CSO Facility Effluent Loadings, Fiscal Year 1998

	Jul	Aug	Sep	Oct	Nov	Dec	Jan	Feb	Mar	Apr	May	Jun	AVG	MAX	Times Detected
Metals (lbs/day)															
CADMIUM		0.01			0.59	0.02		0.01	0.05	0.01	0.03	0.18	0.11	0.59	0 of 9
COPPER		0.27	N		25.60	0.71	N	0.75	1.27	0.32	0.61	4.98	4.31	25.60	9 of 9
LEAD	N	0.21	O	N	8.49	0.73	O	1.25	3.80	0.41	0.73	5.58	2.65	8.49	9 of 10
MERCURY	O	0.00		O	0.01	0.00		0.00	0.01	0.00	0.00	0.08	0.01	0.08	7 of 9
NICKEL		0.12	S		2.34	0.08	S	0.13	0.20	0.05	0.10	0.73	0.47	2.34	2 of 9
ZINC	A	1.14	A	A	16.75	2.39	A	3.31	4.63	1.23	2.30	19.21	6.37	19.21	9 of 9
	C		M	C			M								
Cyanide and Phenols (lbs/day)															
	T		P	T			P								
CYANIDE	I	0.05	L	I	0.29	0.56	L	0.06	0.25	0.07	0.13	0.91	0.29	0.91	1 of 9
PHENOL	V	0.01	E	V	0.06	0.37	E	0.01	0.92	0.01	0.03	0.18	0.20	0.92	2 of 9
	A		S	A			S								
Surfactants (lbs/day)															
	T			T											
SURFACTANTS	I	9.70	T	I	72.64	3.36	T	ND	39.16	9.02	32.64	297.26	66.26	297.26	8 of 8
	O		A	O			A								
Semivolatile Organics (lbs/day)															
	N		K	N			K								
BIS(2-ETHYLHEXYL)PHTHALATE	S	0.01	E	S	0.66	0.02	E	0.12	0.06	0.01	0.03	0.21	0.14	0.66	2 of 9
PHENANTHRENE		0.01	N		0.07	0.00	N	0.03	0.01	0.00	0.00	0.02	0.02	0.07	1 of 9

ND - No Data

Results in ***bold italics*** indicate one or more detects in the month.

Appendix F

Table F-1 Constitution Beach CSO Facility Operations Summary, FY 1998

Table F-2 Constitution Beach CSO Facility BOD and TSS Loadings, FY 1998

Table F-1 Constitution Beach CSO Facility Operations Summary, Fiscal Year 1998

DATE	RAINFALL (inches)	DISCHARGE DURATION (hours)	TOTAL VOLUME (MG)	PH (su)	BOD		TSS		SETTL.	FECAL	CHLORINE	
					INFLUENT (mg/L)	EFFLUENT (mg/L)	INFLUENT (mg/L)	EFFLUENT (mg/L)	SOLIDS (mL/L)	COLIFORM (col/100 ml)	RESIDUAL (mg/L)	
August												
	3	0.44	0.75	0.14	~	~	~	~	~	~	~	~
	9	0.18	0.25	0.08	~	~	~	~	~	~	~	~
	13	0.64	1.75	0.27	~	~	~	~	~	~	~	~
	21	0.85	1.00	0.12	~	~	~	~	~	~	~	~
November												
	1	1.48	8.25	0.82	6.8	24	15	52	20	< 0.1	< 10	2.7
	9	1.28	2.00	0.31	6.8	11	13	23	14	< 0.4	< 10	3.4
January												
	24	1.53	4.00	0.50	7.0	< 14.4	21	28	80	0.6	< 10	ND
February												
	12	0.77	0.75	0.26	~	~	~	~	~	~	~	~
	18	1.91	10.25	0.75	6.5	< 6.47	< 12.9	92	117	< 0.4	50	2.5
	24	2.28	16.50	1.19	6.5	12	< 7.37	62	50	< 0.2	< 10	2.8
	**				6.5	< 9.29	11	50	28	< 0.2	< 10	ND
April												
	17	0.49	0.33	0.06	~	~	~	~	~	~	~	~
	23	1.14	5.00	0.23	6.8	13	14	21	23	< 0.2	< 10	3.2
May												
	4	0.22	0.50	0.21	~	~	~	~	~	~	~	~
	5	0.34	0.50	0.06	~	~	~	~	~	~	~	~
	6	1.00	2.00	0.16	6.8	9	7	28	34	< 0.2	ND	2.7
	7	1.50	1.00	0.26	~	~	~	~	~	~	~	~
	10	1.43	0.50	0.44	~	~	~	~	~	~	~	~
	11	0.81	1.00	0.48	6.9	< 19.3	11	19	21	< 0.4	< 10	3.6

Table F-1 Constitution Beach CSO Facility Operations Summary, Fiscal Year 1998

DATE	RAINFALL (inches)	DISCHARGE	TOTAL	PH (su)	BOD		TSS		SETTL.	FECAL	CHLORINE
		DURATION (hours)	VOLUME (MG)		INFLUENT (mg/L)	EFFLUENT (mg/L)	INFLUENT (mg/L)	EFFLUENT (mg/L)	SOLIDS (mL/L)	COLIFORM (col/100 ml)	RESIDUAL (mg/L)
June											
13	0.08	19.00	0.48	6.9	19	20	90	56	< 0.4	< 10	3.2
14#	5.69	9.00	0.48								
30	1.67	3.00	3.24	~	~	~	~	~	~	~	~
TOTAL		87.33	10.52								
AVERAGE		4.16	0.50		~	~		~	~	11.96	3.01
MINIMUM		0.08	0.06	6.50	< 6.47	< 7.37	19.00	14.00	< 0.1	< 10	2.50
MAXIMUM		5.69	3.24	7.00	33.10	34.30	92.00	186.00	1.20	50.00	4.10
NO. of TIMES CSO ACTIVATED			20								
NO. of DAYS CSO ACTIVATED			21								

Continued from the previous day

** Multiple samples taken

~ No samples taken; station shut down upon arrival at the facility or short activation

ND = No data

Table F-2 Constitution Beach CSO BOD and TSS Loadings, Fiscal Year 1998

DATE	TOTAL VOLUME (MG)	BOD		TSS		
		INFLUENT (lbs/d)	EFFLUENT (lbs/d)	INFLUENT (lbs/d)	EFFLUENT (lbs/d)	
August						
3	0.14	~	~	~	~	
9	0.08	~	~	~	~	
13	0.27	~	~	~	~	
21	0.12	~	~	~	~	
November						
1	0.82	164	103	356	137	
9	0.31	28	34	59	36	
January						
24	0.50	60	88	117	334	
February						
12	0.26	~	~	~	~	
18	0.75	40	80	574	730	
24	1.19	211	89	555	387	
April						
17	0.06	~	~	~	~	
23	0.23	24	26	39	43	
May						
4	0.21	~	~	~	~	
5	0.06	~	~	~	~	
6	0.16	12	9	38	46	
7	0.26	~	~	~	~	
10	0.44	~	~	~	~	
11	0.48	77	44	76	84	

Table F-2 Constitution Beach CSO BOD and TSS Loadings, Fiscal Year 1998

DATE	TOTAL VOLUME (MG)	BOD		TSS	
		INFLUENT (lbs/d)	EFFLUENT (lbs/d)	INFLUENT (lbs/d)	EFFLUENT (lbs/d)
June					
13	0.48	76	80	360	224
14#	0.48				
30	3.24	~	~	~	~
TOTAL	10.52	694.06	553.34		
AVERAGE	0.50	77.12	61.48	241.62	224.49
MINIMUM	0.06	12.08	9.40	37.60	36.20
MAXIMUM	3.24	211.12	102.58	573.93	729.88
NO. of TIMES CSO ACTIVATED			20		
NO. of DAYS CSO ACTIVATED			21		

Continued from the previous day

~ No samples taken; station shut down upon arrival at the facility or short activation

Appendix G

Table G-1 Fox Point CSO Facility Operations Summary, Fiscal Year 1998

Table G-2 Fox Point CSO Facility BOD and TSS Loadings, Fiscal Year 1998

Table G-1 Fox Point CSO Facility Operations Summary, Fiscal Year 1998

DATE	DISCHARGE		TOTAL VOLUME (MG)	PH (su)	BOD		TSS		SETTL. SOLIDS (mL/L)	FECAL COLIFORM (col/100 ml)	CHLORINE RESIDUAL (mg/L)	
	RAINFALL (inches)	DURATION (hours)			INFLUENT (mg/L)	EFFLUENT (mg/L)	INFLUENT (mg/L)	EFFLUENT (mg/L)				
August												
	13	0.64	0.75	1.20	~	~	~	~	~	~	~	
September												
	12	0.26	0.25	0.17	~	~	~	~	~	~	~	
	20	0.40	0.50	1.41	~	~	~	~	~	~	~	
November												
	1	1.48	12.00	5.96	7.2	62	42	142	118	0.4	< 10	3.0
	8	0.69	1.25	0.97	6.9	26	< 13.3	56	30	< 0.2	< 10	3.7
	9	1.28	2.75	1.13	ND	ND	ND	ND	ND	ND	ND	ND
	14	0.96	1.00	1.39	7.2	36	25	24	58	0.2	< 10	4.5
January												
	7	0.71	2.25	1.07	7.0	80	24	230	62	0.4	< 10	3.8
	23	0.73	13.00	14.67	6.6	100	88	218	300	19.0	80	4.2
February												
	12	0.77	0.50	3.67	~	~	~	~	~	~	~	~
	18	1.91	14.50	16.31	7.0	43	37	50	278	0.8	50	4.1
	24	2.28	15.50	10.60	7.0	19	49	42	156	9.0	100	4.1
	**				6.8	50	22	202	26	< 0.2	< 10	ND
	**				7.2	30	37	28	26	0.8	< 10	ND
March												
	9	2.14	14.00	11.52	7.0	91	89	94	106	4.0	100	2.4
	**				7.2	20	13	88	52	< 0.4	< 10	ND
April												
	23	1.14	6.00									
	24#	0.07	3.00	3.54	7.0	27	24	54	26	< 0.2	< 10	2.3

Table G-1 Fox Point CSO Facility Operations Summary, Fiscal Year 1998

DATE	DISCHARGE		TOTAL VOLUME (MG)	PH (su)	BOD		TSS		SETTL. SOLIDS (mL/L)	FECAL COLIFORM (col/100 ml)	CHLORINE RESIDUAL (mg/L)
	RAINFALL (inches)	DURATION (hours)			INFLUENT (mg/L)	EFFLUENT (mg/L)	INFLUENT (mg/L)	EFFLUENT (mg/L)			
May											
6	1.00	3.75	9.50	7.1	73	73	122	116	1.2	130	4.0
7	1.50	1.75	4.10	7.0	~	~	~	~	~	~	2.1
10	1.43	11.00	16.29	6.8	21	11	76	74	< 0.4	< 10	2.8
**					31	41	120	56	< 0.4	30	3.2
11	0.81	4.50	6.58	7.0	25	< 6.88	54	5	< 0.4	< 10	2.4
June											
1	0.22	3.00	3.43	~	~	~	~	~	~	~	~
13	0.08	15.50	10.99	6.8	25	25	48	40	0.4	< 10	1.9
14#	5.69	12.50	39.27	6.9	61	55	30	24	< 0.4	< 10	2.0
15	1.17	6.00	2.55	6.8	35	33	66	56	2.6	< 10	4.1
30	1.67	1.50	ND	7.8	38	57	74	68	5.0	40	2.0
<hr/>											
TOTAL		146.75	166.32								
AVERAGE	1.21	6.11	6.93		45	38	91	84	2	19	3.1
MINIMUM	0.07	0.25	0.17	6.60	18.60	< 6.88	24.00	5.00	< 0.2	< 10	1.93
MAXIMUM	5.69	15.50	39.27	7.80	100.00	89	230.00	300.00	19	130	4.50

NO. of TIMES CSO ACTIVATED 22
 NO. of DAYS CSO ACTIVATED 24

Continued from the previous day

** Multiple samples taken

~ No samples taken; station shut down upon arrival at the facility or short activation

ND = No data

Table G-2 Fox Point CSO BOD and TSS Loadings, Fiscal Year 1998

DATE	TOTAL VOLUME (MG)	BOD		TSS	
		INFLUENT (lbs/d)	EFFLUENT (lbs/d)	INFLUENT (lbs/d)	EFFLUENT (lbs/d)
August					
13	1.20	~	~	~	~
September					
12	0.17	~	~	~	~
20	1.41	~	~	~	~
November					
1	5.96	3,087	2,078	7,058	5,865
8	0.97	210	108	453	243
9	1.13	ND	ND	ND	ND
14	1.39	418	294	278	672
January					
7	1.07	714	213	2,052	553
23	14.67	12,235	10,803	26,672	36,704
February					
12	3.67	~	~	~	~
18	16.31	5,807	5,046	6,800	37,808
24	10.60	2,916	3,169	8,012	6,126
March					
9	11.52	5,332	4,900	8,743	7,590
April					
24#	3.54	783	721	1,595	768

Table G-2 Fox Point CSO BOD and TSS Loadings, Fiscal Year 1998

DATE	TOTAL VOLUME (MG)	BOD		TSS		
		INFLUENT (lbs/d)	EFFLUENT (lbs/d)	INFLUENT (lbs/d)	EFFLUENT (lbs/d)	
May						
6	9.50	5,813	5,813	9,662	9,187	
7	4.10	~	~	~	~	
10	16.29	3,533	3,533	13,317	8,832	
11	6.58	1,378	378	2,965	275	
June						
1	3.43	~	~	~	~	
13	10.99	2,246	2,328	4,400	3,666	
14	39.27	20,011	18,046	9,825	7,860	
15	2.55	742	695	1,404	1,191	
30	ND					
<hr/>						
TOTAL	166.32					
AVERAGE	6.93	3,775	3,474	6,976	9,025	
MINIMUM	0.17	210	108	278	243	
MAXIMUM	39.27	20,011	18,046	26,672	37,808	

NO. of TIMES CSO ACTIVATED 21
 NO. of DAYS CSO ACTIVATED 24

Continued from previous day

~ No samples taken; station shut down upon arrival at the facility or short activation

ND = No data

Appendix H

Table H-1 Commercial Point CSO Facility Operations Summary, FY 1998

Table H-2 Commercial Point CSO Facility BOD and TSS Loadings, FY 1998

Table H-1 Commercial Point CSO Facility Operations Summary, Fiscal Year 1998

DATE	RAINFALL (inches)	DISCHARGE DURATION (hours)	TOTAL VOLUME (MG)	PH (su)	BOD		TSS		SETTL. SOLIDS (mL/L)	FECAL COLIFORM (col/100 ml)	CHLORINE RESIDUAL (mg/L)	
					INFLUENT (mg/L)	EFFLUENT (mg/L)	INFLUENT (mg/L)	EFFLUENT (mg/L)				
August												
	13	0.64	2.50	1.58	7.0	< 137	13	224	44	< 0.4	< 10	2.7
	21	0.85	0.50	0.44	~	~	~	~	~	~	~	~
September												
	12	0.26	0.25	0.14	~	~	~	~	~	~	~	~
November												
	1	1.48	10.50	5.43	6.8	< 25.6	< 30.7	120	418	2	< 10	3.1
	8	0.69	1.50	1.02	6.0	18	< 11.1	1230	16	< 0.4	< 10	2.5
	9	1.28	4.25	2.20	6.6	46	< 6.41	74	27	< 0.4	< 10	3.3
	14	0.96	1.00	1.25	7.2	17	16	30	34	< 0.1	< 10	4.2
	22	0.79	0.75	0.97	6.9	15	14	42	26	< 0.2	< 10	4.5
December												
	30	0.3	6.00	2.87	6.8	33	34	92	186	1	10	4.1
January												
	9	0.3	4.00	0.66	7.0	445	16	252	170	1	3900	2.1
	23	0.73	13.50	13.96	6.8	47	30	196	158	3	< 10	3.7
February												
	12	0.77	4.25	1.76	6.8	< 42.2	22	176	212	2	< 10	4.7
	18	1.91	14.00	11.94	7.0	26	< 12.9	56	110	0.4	10	1.8
	24	2.28	16.50	8.71	7.9	11	10	46	64	< 0.2	< 10	2.0
	**				6.9	11	8	41	32	< 0.2	< 10	
March												
	9	2.14	12.50	12.48	7.1	< 23.5	11	202	140	0.4	10	2.3
	**				6.9	< 16.9	11	114	94	< 0.2	< 10	
April												
	17	0.49	0.25	0.75	~	~	~	~	~	~	~	~
	23	1.14	6.00									
	24#	0.07	3.50	1.94	7.0	9	43	23	15	< 0.2	< 10	3.7

Table H-1 Commercial Point CSO Facility Operations Summary, Fiscal Year 1998

DATE	RAINFALL (inches)	DISCHARGE DURATION (hours)	TOTAL VOLUME (MG)	PH (su)	BOD		TSS		SETTL. SOLIDS (mL/L)	FECAL COLIFORM (col/100 ml)	CHLORINE RESIDUAL (mg/L)	
					INFLUENT (mg/L)	EFFLUENT (mg/L)	INFLUENT (mg/L)	EFFLUENT (mg/L)				
May												
6	1.00	4.50	2.80	6.8	26	44	240	290	3	90	2.8	
**				6.9	12	9	114	48	< 0.2	< 10	2.7	
7	1.50	1.75	5.04	7.1	9	20	40	226	1	10	4.1	
**					49	10	420	144	1	< 10	ND	
10	1.43	6.50	5.63	7.0	17	23	42	50	2	40	3.0	
**		7.50	6.87	7.0	< 17.1	9	30	46	1	570	2.9	
11	0.81	5.25	4.67	7.0	< 26.8	< 6.88	22	34	< 0.4	< 10	2.8	
June												
1	0.22	2.75	1.16	~	~	~	~	~	~	~	~	
3	0.38	1.00	1.31	~	~	~	~	~	~	~	~	
13	0.08	17.25	16.12	6.8	19	109	80	388	6	200	3.0	
14#	5.69	9.50	8.88									
15	1.17	5.00	4.16	7.00	21	14	114	60	0.4	< 10	3.0	
30	1.67	3.50	\$	~	~	~	~	~	~	~	~	
TOTAL		166.25	124.74									
AVERAGE		5.73	4.30		45.00	21.00	160.80	121.28	1.10	19	3.13	
MINIMUM		0.07	0.14	6.00	< 17.1	< 6.41	22.00	15.00	< 0.1	< 10	1.80	
MAXIMUM		5.69	16.12	7.85	445.00	109.00	1230.00	418.00	6.00	3900	4.70	

NO. of TIMES CSO ACTIVATED 26
 NO. of DAYS CSO ACTIVATED 29

Continued from the previous day
 ** Multiple samples taken
 ~ No samples taken; station shut down upon arrival at the facility or short activation
 ND = No data
 \$ Meter malfunction, no flow data.

Table H-2 Commercial Point CSO BOD and TSS Loadings, Fiscal Year 1998

DATE	TOTAL VOLUME (MG)	BOD		TSS		
		INFLUENT (lbs/d)	EFFLUENT (lbs/d)	INFLUENT (lbs/d)	EFFLUENT (lbs/d)	
August						
13	1.58	1,805	171	2,952	580	
21	0.44	~	~	~	~	
September						
12	0.14	~	~	~	~	
November						
1	5.43	1,159	1,390	5,434	18,930	
8	1.02	151	94	10,463	136	
9	2.20	837	118	1,358	495	
14	1.25	181	165	313	354	
22	0.97	123	111	340	210	
December						
30	2.87	792	821	2,202	4,452	
January						
9	0.66	2,449	86	1,387	936	
23	13.96	5,460	3,470	22,820	18,395	
February						
12	1.76	619	317	2,583	3,112	
18	11.94	2,569	1,285	5,576	10,954	
24	8.71	785	654	3,160	3,487	
March						
9	12.48	2,134	1,166	16,445	12,178	
April						
17	0.75	~	~	~	~	
24#	1.94	142	696	372	243	

Table H-2 Commercial Point CSO BOD and TSS Loadings, Fiscal Year 1998

DATE	TOTAL VOLUME (MG)	BOD		TSS		
		INFLUENT (lbs/d)	EFFLUENT (lbs/d)	INFLUENT (lbs/d)	EFFLUENT (lbs/d)	
May						
6	2.80	444	619	4,133	3,946	
7	5.04	1,219	631	9,668	7,776	
10	12.50	1,814	1,668	3,753	5,004	
11	4.67	1,044	268	857	1,324	
June						
1	1.16	~	~	~	~	
3	1.31	~	~	~	~	
13	16.12	2,595	14,654	10,755	52,163	
14#	8.88					
15	4.16	711	468	3,955	2,082	
30	\$					
<hr/>						
TOTAL	124.74					
AVERAGE	4.46	1,352	1,443	5,426	7,338	
MINIMUM	0.14	123	86	313	136	
MAXIMUM	16.12	5,460	14,654	22,820	52,163	

NO. of TIMES CSO ACTIVATED 25
 NO. of DAYS CSO ACTIVATED 28

Continued from the previous day
 ** Multiple samples taken
 ~ No samples taken; station shut down upon arrival at the facility or short activation
 \$ Meter malfunction, no flow data.

Appendix I

NPDES Monitoring Requirements

The Environmental Protection Agency (EPA) mandates that any discharge to a body of water must be permitted through the National Pollutant Discharge Elimination System (NPDES). The EPA and the Massachusetts Department of Environmental Protection (DEP) jointly issued a NPDES permit to MWRA for its two primary treatment plants on Deer Island and Nut Island, and three CSO treatment facilities, Cottage Farm, Prison Point, and Somerville Marginal. MWRA also owns and operates three additional CSO facilities, Constitution Beach, Fox Point, and Commercial Point. The effluent from these three gravity CSO facilities discharges to the City of Boston sewer lines. Thus, the Boston Water and Sewer Commission (BWSC) NPDES permit allows for the ultimate discharge of the effluent from those facilities.

The limits set in the MWRA NPDES permit are limitations for secondary treatment plants. Since neither the Nut Island nor the Deer Island plant had secondary treatment facilities (the initial phase of Deer Island secondary treatment began in FY98), MWRA currently operates under court-ordered interim limits while the upgrade of the Deer Island secondary treatment plant is being completed. A new NPDES permit is expected to become effective in FY99.

In addition, MWRA, through the NPDES Pretreatment Program, monitors the influent quality of wastewater. Those monitoring results provide the basis for determining the adequacy of existing Local Limits to protect the treatment plants and Boston Harbor. Local Limits allow the discharge of toxic chemicals from industrial sources to be regulated. Current Local Limits were enacted in FY94 and, under the Pretreatment Program requirements, must be re-evaluated every five years.

MWRA not only monitors to comply with the NPDES requirements, but also has its own monitoring programs, including Plant Monitoring and Receiving Water Monitoring. These monitoring programs serve to assure appropriate control of discharges to the system, to assure the most cost-effective

wastewater treatment while meeting water quality standards, and to assure the quality of life of the organisms and health of the animal communities living in the receiving bodies of water.

I.1 Permits and Compliance Order

I.1.a NPDES Permit

Under the NPDES permit, “in compliance with the provisions of the Clean Water Act, as amended, 33 U.S.C. § 1251 et seq., and the Massachusetts Clean Water Act, as amended, Mass. Gen. Laws, ch. 21, § 266-53, the MWRA is permitted to discharge from (MWRA Publicly Owned Treatment Works, CSO Treatment Facilities, and CSO Outfalls), in accordance with effluent limitations, monitoring limitations, and other conditions...”

Monitoring Requirements and Effluent Limitations: The NPDES permit establishes monitoring requirements for existing POTW outfalls as well as for CSO treatment facility outfalls. In addition, the permit mandates CSO outfall identification and receiving water monitoring. It also establishes numerical limitations for certain parameters as well as narrative limits for all authorized discharges.

Reporting Requirements: In addition to POTW and CSO monitoring requirements, the NPDES permit requires certain reports on the state of MWRA sewerage and operational systems. These include the Infiltration/Inflow Report, CSO Facilities and Systems Inspection, reports on operational upsets, Overflow Reports, Operations Bypass Reports, Monthly Discharge Monitoring Reports (DMRs), and reporting on the effects of discharges (Annual Bioaccumulation Study). Table I-1 presents a summary of the permit limits and monitoring requirements for POTWs while Table I-2 presents permit limits for CSOs.

I.1.b Court Order

MWRA also operates under a court order issued in June 1986. In addition to establishing interim discharge limits for existing treatment plants, the court order established a schedule for MWRA to upgrade the sewerage system and treatment plants. Table I-3 summarizes the court-ordered interim limits for both the Deer Island and Nut Island Treatment Plants.

Table I-1

NPDES PERMIT			
Effluent Limitations and Monitoring Requirements for POTW Outfalls			
Deer Island and Nut Island Treatment Plants			
Effluent Characteristic	Discharge Limitation		
	Average Monthly	Average Weekly	Maximum Daily
BOD	*	*	*
TSS	*	*	*
Settleable Solids	*	*	*
pH	Not less than 6.5 nor greater than 8.5 at any time to Boston Harbor, Quincy Bay, Hingham Bay, the Inner Harbor and the Mystic River.		
Fecal Coliform	*	*	*
Total Coliform	*	*	*
Chlorine, Total Residual	<p>(1) The total chlorine residual and other toxic components of the effluent shall not result in any demonstrable harm to aquatic life or violate any state or federal water quality standard which has been or may be promulgated. Upon promulgation of any such standards, this permit may be modified in accordance with such standards.</p> <p>(2) The permittee shall minimize the use of chlorine, still maintaining adequate bacterial control.</p>		
Oil and Grease of Petroleum Origin (also called TPH or PHC)	N/A	N/A	15 mg/L

* Court ordered interim limit applies to this parameter.

Table I-1 [cont.]

NPDES PERMIT Effluent Limitations and Monitoring Requirements for POTW Outfalls Deer Island and Nut Island Treatment Plants	
Effluent Characteristic	Discharge Limitation
NOEC ^a	10% or greater (10% or more of the sample is composed of effluent; remainder is dilution water)
	Chronic toxicity tests to establish the NOEC (No Observed Effect Concentration): Chronic toxicity tests on representative 24-hour composite samples of the discharge using each of the following organisms: (i) the sheepshead minnow, <i>Cyprinodon variegatus</i> (7-day tests to measure growth and survival); and (ii) the red marine alga, <i>Champia parvula</i> (multi-day tests to evaluate the effects on sexual reproduction).
NOAEL ^b and LC50 ^c	Acute static toxicity tests to establish the NOAEL (No Observed Acute Effect Level) and LC50 of the effluent: 96-hour acute static toxicity tests on representative 24-hour composite samples of the discharge using one to five-day-old juvenile mysid shrimp, <i>Mysidopsis bahia</i> .
NOAEL	20% or greater (20% or more of the sample is composed of effluent)
Other Monitored Parameters	Pollutants listed in 40 CFR Part 122 Appendix D. (See Table L-3 of Appendix L in this report.)

^a NOEC: No Observed Effect Concentration is the highest concentration of effluent to which organisms are exposed in a life cycle or partial life cycle test which has no adverse effects (on growth, survival and reproduction).

^b NOAEL: No Observed Acute Effect Level is the highest concentration of effluent to which organisms are exposed in a short-term test in which at least 90% of the test organisms survive.

^c LC50: the concentration of effluent in a sample that causes mortality in 50% of the test population at a specific time of observation.

Table I-2

NPDES PERMIT Effluent Limitations and Monitoring Requirements for CSO Treatment Facility Outfalls	
Characteristic	Discharge Limitation
pH	The pH of the effluent shall not be (1) less than 6.5 nor greater than 8.5 at any time to the Inner Harbor and Mystic River (2) less than 6.5 nor greater than 9.0 at any time to the Charles River
Fecal Coliform	(1) Maximum monthly geometric mean: 1000 col/100 mL (2) Not more than 10% of the total samples can exceed 2500 col/100 mL during any monthly sampling period.
Chlorine, Total Residual	(1) The total chlorine residual and other toxic components of the effluent shall not result in any demonstrable harm to aquatic life or violate any state or federal water quality standard which has been or may be promulgated. Upon promulgation of any such standard, this permit may be modified in accordance with such standard. (2) The permittee shall minimize the use of chlorine, still maintaining adequate bacterial control.
Other Monitored Parameters	
Rainfall/Precipitation	
Flow	
BOD ^a	
TSS ^a	
Settleable Solids	

^a Report both influent and effluent results for this parameter.

Table I-2 [cont.]

NPDES PERMIT Effluent Limitations and Monitoring Requirements for CSO Treatment Facility Outfalls
NOAEL ^b
LC50 ^b
Cadmium ^c
Chromium (Hexavalent) ^c
Copper ^c
Lead ^c
Mercury ^c
Nickel ^c
Zinc ^c
Chlorinated Hydrocarbons ^c
Ammonia Nitrogen ^c
Total Phosphorus ^c
Pesticides ^c
PAHs ^c
VOCs ^c

^b Only required to be monitored in the first and fifth year of the permit. Has not been monitored since the permit expired.

^c Only required to be monitored in the first and fifth year of the permit, although MWRA has been continually monitoring these parameters since the start of the permit.

Table I-3

COURT ORDERED SEWAGE TREATMENT PLANT INTERIM LIMITATIONS			
Effluent Characteristic	Effluent Limits		
	Average Monthly	Maximum Daily	Percent Removal*
Deer Island			
BOD	140 mg/L	200 mg/L	27%
TSS	110 mg/L	180 mg/L	38%
Settleable Solids	2.8 mL/L	N/A	N/A
Fecal Coliform	200 col/100 mL	N/A	N/A
Total Coliform	1000 col/100 mL	N/A	N/A
pH	The pH of the effluent shall not be less than 6.5 nor greater than 8.5 at any time unless these values are exceeded due to natural causes or as a result of approved modifications of treatment processes.		
Nut Island			
BOD	130 mg/L	185 mg/L	15%
TSS	110 mg/L	195 mg/L	43%
Settleable Solids	1.8 mL/L	N/A	N/A
Fecal Coliform	200 col/100 mL	N/A	N/A
Total Coliform	1000 col/100 mL	N/A	N/A
pH	The pH of the effluent shall not be less than 6.5 nor greater than 8.5 at any time unless these values are exceeded due to natural causes or as a result of approved modifications or treatment processes.		

* Percent Removal is based on a 12-month running average.

Table I-3 [cont.]

COURT ORDERED SEWAGE TREATMENT PLANT INTERIM LIMITATIONS	
Other Effluent Limitations	
Chlorine	The Authority shall minimize the use of chlorine consistent with maintaining adequate bacterial control.
Reduction of Suspended Solids	Volatile suspended solids shall be reduced through anaerobic digestion, with percentage reductions to be computed as a two month rolling average: Deer Island 50%, Nut Island 61%.
Special Monitoring of Oil and Grease	The Authority shall separately measure the concentration of the following by means of a weekly grab sample: Influent oil and grease, effluent oil and grease, digester sludge influent oil and grease, and digester sludge effluent oil and grease.

I.2 Monitoring Programs

In FY98, MWRA conducted several monitoring programs. However, this report will present only the influent and effluent monitoring programs. The report will also include information on the “critical areas” in MWRA and community sewer systems that have historically discharged during and after heavy rainstorms. These “critical areas” were monitored and inspected as part of the NPDES monitoring program.

I.2.a Treatment Plant Monitoring Program

The Treatment Plant Monitoring Program has two main components: The Influent Monitoring Program and the Effluent Monitoring Program.

The Influent Monitoring Program characterizes the influent to the Deer Island and Nut Island Treatment Plants. Influent monitoring for conventional parameters, in addition to being mandated by the NPDES permit, is also necessary for process control. Data from the Influent Monitoring

Program provide influent loading rates and the basis for determining treatment plant efficiency. In addition, influent monitoring for non-conventional parameters is mandated by the NPDES Permit Pretreatment Program.

The Effluent Monitoring Program characterizes the quality of the effluent discharged to a receiving body of water. Except for whole effluent toxicity (WET) testing, the parameters measured in the effluent are the same as those measured in the influent. The NPDES permit requires effluent monitoring and imposes permit limits to ensure the health of the receiving water.

Table I-4 lists the treatment plant monitoring program parameters, including sample type, sampling frequency and analytical procedures used.

1.2.b Combined Sewer Overflow Facilities Monitoring Program

The CSO Monitoring Program includes influent and effluent monitoring at the six CSO facilities, although only three of them are currently included in the MWRA NPDES permit. Influent and effluent samples are collected and tested for conventional parameters at all six CSO facilities. For the permitted facilities, in addition to conventional parameters, select priority pollutants are also analyzed in the effluent. Table I-5 lists the CSO monitoring program parameters, including sample type, sampling frequency and analytical procedures used.

1.2.c Sewer System Monitoring Program

The Sewer System Monitoring Program, which attempts to identify Sanitary Sewer Overflows (SSOs), involves conducting visual inspections of areas in the sewer system that have a history of discharging during or shortly after a heavy rainfall event. Because of the hydraulics of the South System, discharges occur in manholes or other low-lying areas, while discharges in the North System are the result of combined sewage overwhelming sewage system capacity.

I.3 Treatment of Results

It can be difficult to interpret laboratory results and to ensure that they are representative of the sample, especially when the results are at or below method detection levels. For the conventional parameters measured in these monitoring programs, calculating the average concentration of a particular parameter was straightforward: the arithmetic average was used. However, the concentrations of metals, pesticides and organics are very frequently below method detection levels, and data were manipulated. Appendix K gives a brief description of method detection limits and how measurements below detection limits are treated in this report.

Daily loadings were calculated using the formula:

$$\text{Loadings (lbs/day)} = Q * C * 8.34$$

where Q= flow (mgd)

C = concentration (mg/L)

8.34 = unit conversion factor

Monthly average concentrations for priority pollutants (metals, cyanide, pesticides/PCBs and organic compounds) were calculated by adding the loadings of the pollutant during each sampling event for that month and then dividing it by the total flow during those sampling events.

Average annual concentrations were calculated using the same method, taking each individual sampling event into account in the calculation.

It should be kept in mind that with the large flows going through both Deer and Nut Island Treatment Plants, taking one small sample may not always be truly representative. It is also important to keep in mind that certain parameters (conventional) were analyzed daily while other parameters (priority pollutants) were analyzed only two or three times per month.

**Table I-4
POTW Monitoring Program**

Parameter	Sample Type ¹	Sampling Frequency		Analytical Method ²
		Influent	Effluent	
Metals				
Antimony	Composite	8 x per month	8 x per month	204.2
Arsenic	Composite	8 x per month	8 x per month	206.2
Beryllium	Composite	8 x per month	8 x per month	200.7
Boron	Composite	8 x per month	8 x per month	200.7
Cadmium	Composite	8 x per month	8 x per month	213.1
Chromium	Composite	8 x per month	8 x per month	200.7
Lead	Composite	8 x per month	8 x per month	239.2
Mercury	Composite	8 x per month	8 x per month	245.1
Molybdenum	Composite	8 x per month	8 x per month	200.7
Nickel	Composite	8 x per month	8 x per month	200.7
Selenium	Composite	8 x per month	8 x per month	270.2
Silver	Composite	8 x per month	8 x per month	200.7
Thallium	Composite	8 x per month	8 x per month	279.2
Zinc	Composite	8 x per month	8 x per month	200.7
Cyanide	Grab	3 x per month	3 x per month	335.2
TPH	Grab	3 x per month	6-7 x per month	418.1
Pesticides/PCBs	Composite	3 x per month	3 x per month	608
Semi-volatiles	Composite	2 x per month	3 x per month	625
Volatiles	Grab	2 x per month	3 x per month	624
Whole Effluent Toxicity ³	Composite		1 x per month	WET Test Protocols

¹ Influent and effluent composite samples are 24-hour time composite samples.

² EPA Methods.

³ Effluent sample only.

**Table I-4 [cont.]
POTW Monitoring Program**

Parameter	Sample Type ¹	Sampling Frequency		Analytical Method ²
		Influent	Effluent	
Conventional				
pH	Grab	1 x per day	1 x per day	150.1
Settleable Solids	Grab	1 x per day	1 x per day	160.5
Biochemical Oxygen Demand	Composite	1 x per day	1 x per day	405.1
Carbonaceous BOD	Composite	1 x per day	1 x per day	405.1
Chemical Oxygen Demand	Composite	1 x per day	1 x per day	410.1
Total Suspended Solids	Composite	1 x per day	1 x per day	160.2
Total Coliform	Grab		3 x per day	9222 D ³
Fecal Coliform	Grab		3 x per day	9222 B ³
Oil and Grease	Grab	1 x per week	1 x per week	413.1
Chlorides	Composite	1 x per day		4500 B ³
Total Chlorine Residual	Grab		3 x per day	330.5
Nutrients⁴				
Total Kjeldahl Nitrogen	Composite	1 x per week	1 x per week	351.3
Ammonia	Composite	1 x per week	1 x per week	350.2
Nitrates	Composite	1 x per week	1 x per week	353.3
Nitrites	Composite	1 x per week	1 x per week	354.1
Orthophosphorus	Composite	1 x per week	1 x per week	365.2
Total Phosphorus	Composite	1 x per week	1 x per week	365.2

¹ Influent and effluent composite samples are 24-hour time composite samples.

² EPA Methods.

³ Standard Methods.

⁴ Sampling frequency is once a week at Deer Island but once a month at Nut Island.

**Table I-5
CSO Monitoring Program**

Parameter	Sample Type	Sampling Frequency	Analytical Method¹
pH	Grab ²	See Footnote 2	150.1
Biochemical Oxygen Demand	Grab ²	See Footnote 2	405.1
Total Suspended Solids	Grab ²	See Footnote 2	160.2
Settleable Solids	Grab ²	See Footnote 2	160.5
Fecal Coliform	Grab ²	See Footnote 2	9222 B ³
Total Chlorine Residual	Grab ²	See Footnote 2	330.5

¹ EPA Methods.

² Grab samples are collected once within the first 2 hours of each discharge from the CSO treatment facility and every eight hours thereafter.

³ Standard Methods.

Appendix J

An Overview of the MWRA Sewerage System and Facilities

MWRA is responsible for the collection, transport, pumping, treatment and disposal of sewage in Boston and the greater Boston area. In addition to the Deer Island and Nut Island Treatment Plants, MWRA operates a third treatment plant, which serves the town of Clinton and the Lancaster Sewer District under special arrangements that originated when the Metropolitan District Commission (MDC) acquired land in Clinton for the Wachusett Reservoir. The Clinton Treatment Plant operates under a separate permit from the Boston NPDES permit and is not discussed in this report.

MWRA serves 43 communities with a total population of about two million people, 5,500 businesses and 1,400 industries. More than 5,400 miles of town- and city-owned local sewers connect at over 1,800 points to over 230 miles of MWRA interceptor sewers. Also included in the vast sewerage system are eleven pumping stations, four headworks, over 80 combined sewer relief overflows, six CSO treatment facilities and two treatment plants. Table J-1 lists the MWRA treatment facilities and relevant information pertaining to each facility.

The two plants, on Deer Island in Winthrop and on Nut Island in Quincy, serve the 43 communities in the metropolitan Boston sewerage system and are allowed to discharge under the Boston NPDES Permit. The sewerage system is divided into two major regions: the North and the South. Deer Island provides secondary treatment to sewage flows from the North System while Nut Island provides primary treatment to sewage flows from the South System. By the beginning of Fiscal Year 1999, both South and North System flows will be treated at Deer Island, and the Nut Island Treatment Plant will be decommissioned. Table J-2 lists the sewerage service area population by community.

Table J-1 List of Treatment Facilities and Discharge Locations

Facility Name	Location	First year of Operation	Treatment Process	Design Flow (mgd)	Conduit Size At Facility: In	Conduit Size At Facility: Out	Outfall Number	Receiving Water
POTW								
Deer Island	Deer Island Boston, MA (North System)	1968	Screening Sedimentation Chlorination	343		9'x 10' 6'x 6.5' BLOCKED 9' Dia	MWR001 MWR002 MWR003 MWR004	Boston Harbor
Nut Island	147 Sea St. Quincy, MA (South System)	1952	Screening Sedimentation Chlorination	112		5'Dia 5'Dia 5'Dia 5'Dia	MWR101 MWR102 MWR103 MWR104	Boston Harbor
CSO FACILITIES								
Cottage Farm	Memorial Dr. near Boston University Bridge, Cambridge	1971	Screening Settling Chlorination Detention	233	72" N. Charles Relief 42" S. Charles Relief 54" Brookline	96" Outfall	MWR201	Charles River
Prison Point	Near Museum of Scienc Bridge, Cambridge	1980	Screening Settling Chlorination Detention	385	10' Conduit	8' Conduit	MWR203	Inner Harbor
Somerville Marginal	McGrath Highway unde Route I-93, Somerville	1973*	Screening Chlorination	245	7' x 7.5' Conduit 84" Conduit	6' x 8' Conduit	MWR205	Mystic River
Constitution Beach	Off Shore St. East Boston	1987	Screening Chlorination	20	36" Conduit	36" Conduit	BOS002	Boston Harbor
Fox Point	Freeport Street near Southeast Expressway, Dorchester	1989	Screening Chlorination	119	10' x 12' Conduit	10' x 12' Conduit	BOS089	Dorchester Bay
Commercial Point	Victory Road Dorchester	1991	Screening Chlorination	194	15' x 11' Conduit	15' x 11' Conduit	BOS090	Dorchester Bay

* Rehabilitated in 1988
MWR refers to MWRA
BOS refers to BWSC

**Table J-2
Sewerage Service Area Population By Community**

TOWN	COMMUNITY POPULATION ¹	SEWERED POPULATION ²	North System	South System	North System ³	South System ³
Arlington	43,656	43,612	x		43,612	
Ashland	12,940	8,152		x		8,152
Bedford	13,676	11,761	x		11,761	
Belmont	24,044	23,539	x		23,539	
Boston	558,394	557,836	x	x	420,274	137,562
Braintree	34,708	34,673		x		34,673
Brookline	54,137	53,704	x	x	23,420	30,284
Burlington	23,493	22,553	x		22,553	
Cambridge	93,707	93,613	x		93,613	
Canton	20,314	14,626		x		14,626
Chelsea	27,608	27,580	x		27,580	
Dedham	23,741	22,269		x		22,269
Everett	35,006	34,971	x		34,971	
Framingham	64,536	59,760		x		59,760
Hingham	6,235	5,206		x		5,206
Holbrook	11,092	7,210		x		7,210
Lexington	29,484	27,715	x		27,715	
Malden	52,749	52,696	x		52,696	
Medford	56,190	56,134	x		56,134	
Melrose	27,426	27,399	x		27,399	
Milton	25,794	23,988	x	x	2,240	21,748
Natick	31,310	25,831		x		25,831
Needham	27,828	25,323		x		25,323
Newton	80,238	78,312	x	x	42,860	35,452
Norwood	28,899	28,552		x		28,552
Quincy	85,532	85,446		x		85,446
Randolph	30,554	30,248		x		30,248
Reading	22,956	21,349	x		21,349	
Revere	41,761	41,719	x		41,719	
Somerville	74,356	74,282	x		74,282	
Stoneham	22,131	21,578	x		21,578	
Stoughton	27,481	17,313		x		17,313
Wakefield	24,756	23,692	x		23,692	
Walpole	22,251	14,018		x		14,018
Waltham	57,214	57,157	x		57,157	
Watertown	32,490	32,458	x		32,458	
Wellesley	26,809	25,254		x		25,254
Westwood	12,935	10,865		x		10,865
Weymouth	54,847	51,008		x		51,008
Wilmington	19,874	3,001	x		3,001	
Winchester	20,318	20,298	x		20,298	
Winthrop	17,305	17,288	x		17,288	
Woburn	36,628	35,712	x		35,712	
TOTALS	2,037,403	1,949,701			1,258,901	690,800

¹ Community population data are from Federal Census Bureau estimates of 1996 population.

² MWRA, preliminary sewer rates estimates for FY00.

³ Boston, Brookline, Milton, and Newton cross over between the North and South Systems. Population data for these communities estimated by MWRA's Infiltration/Inflow Program.

J.1 North System

The North System serves a population of about 1.3 million and is located to the north and west of Boston. Most of the North System is a separate system in which sanitary wastewater and stormwater are carried in different conduits. However, portions of Boston, Cambridge, Somerville and Chelsea still have combined sewers. Community sewer lines tie into the MWRA system through interceptor lines that feed into remote headwork facilities.

Three remote headworks connect to the North Main Pump Station (NMPS) at Deer Island by two deep rock tunnels, the Boston Main Drainage Tunnel (BMDT) and the North Facilities Metropolitan Relief Tunnel (North Metro Relief). The seven-mile BMDT originates from the Ward Street Headworks, continues to the Columbus Park Headworks, and runs under Boston Harbor to the NMPS. The four-mile North Metro Relief Tunnel connects the Chelsea Creek Headworks to the NMPS. The two tunnels combined can handle approximately 800 mgd, matching the combined peak flow capacity of 788 mgd from the three remote headworks.

A fourth headworks facility, the Winthrop Terminal, is located on Deer Island and receives flows from the city of Winthrop and the East Boston (Caruso) Pump Station through the North Metro Trunk Sewer. Figure J-1 shows the North System schematics.

Figure J-1
North System Pump Stations, Headworks, CSOs and Tunnel Hydraulic Schematic

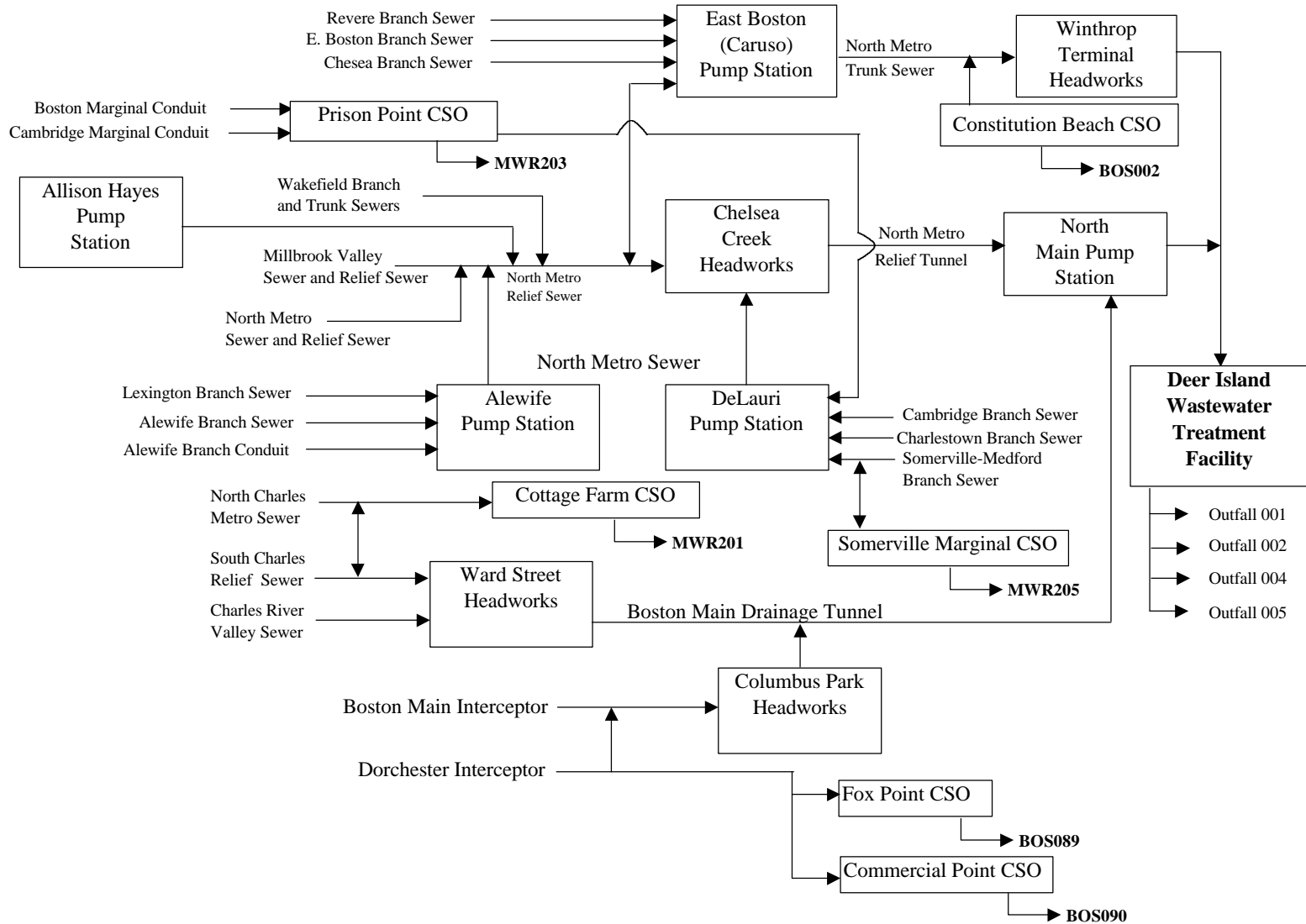

J.1.a Pump Stations

The MWRA North System has four pump stations. Alewife Brook (64 mgd), Caruso (110 mgd), DeLauri (90 mgd) and Allison Hayes (11 mgd) pump stations convey wastewater to the headworks facilities. The four pump stations receive flow from interceptor lines as follows:

Alewife Brook Pump Station	Lexington Branch Sewer Alewife Branch Sewer Alewife Branch Conduit
Caruso (East Boston) Pump Station	Revere Branch Sewer East Boston Branch Sewer Chelsea Branch Sewer North Metro Relief Sewer *
DeLauri Pump Station	Cambridge Branch Sewer Charlestown Branch Sewer Medford-Somerville Branch Sewer Prison Point Pump Station Somerville Marginal CSO overflow **
Allison Hayes Pump Station	Wakefield Branch Sewer

* When flow to the Chelsea Headworks is held back, wastewater is diverted to the Caruso Station.

** During low-intensity rainfall when line capacity is not exceeded, the combined wastewater is pumped back to the trunk sewers and ultimately to the DeLauri Station.

J.1.b Headworks

The Deer Island Treatment Plant receives flow from three remote headworks and the Winthrop Terminal Headworks. The three remote headworks, the Ward Street Headworks (256 mgd) located in Roxbury, the Columbus Park Headworks (182 mgd) located in South Boston, and the Chelsea Creek Headworks (350 mgd) located in Chelsea, have a combined pumping capacity of 788 mgd. The Winthrop Terminal Headworks (125 mgd) is located on Deer Island. The four headworks receive flows from interceptor lines or pump stations as follows:

Ward Street Headworks	South Charles Relief Sewer Charles River Valley Sewer North Charles Metro Sewer * Cottage Farm CSO *
Columbus Park Headworks	Boston Main Interceptor Dorchester Interceptor
Chelsea Creek Headworks	Alewife Pump Station North Metro Relief Sewer DeLauri Pump Station Caruso Pump Station Overflow
Winthrop Terminal Headworks	Winthrop Sewer Caruso Pump Station **

* During low-intensity rainfall when line or holding capacity are not exceeded, the combined wastewater is pumped back to the trunk sewers and ultimately to the Ward Street Headworks.

** Overflow from the Caruso Pump Station.

J.1.c Deer Island Treatment Plant

The Deer Island Treatment Plant receives wastewater at the North Main Pumping Station (NMPS) and the Winthrop Terminal. The NMPS consists of ten pumps, each rated at 110 mgd, for a total pumping capacity of 1,100 mgd. Beginning with the next fiscal year (in July 1998), all of the South System flow will be treated at Deer Island. The new South System Pump Station consists of eight pumps, each rated at 66.7 mgd. During the last quarter of FY98, a portion of the South System flow

was brought to Deer Island for treatment, in order to test the South System Pump Station and other equipment.

The Deer Island Primary Treatment Plant, in operation since June of 1968, serves 22 communities and portions of Boston, Brookline, Newton and Milton. The service area encompasses approximately 168 square miles. Grit removal and screening is provided at the remote headworks. Flow from the city of Winthrop is degrittied at the Winthrop Terminal. Grit chambers and screens remove heavy particles and debris from the wastewater. Grit and screenings are landfilled off-site.

The new primary treatment plant came on-line on January 21, 1995. Secondary treatment was initiated at Deer Island in July 1997. By the end of FY98, there were two batteries of secondary treatment on-line. A third battery will be added sometime in FY00. Figure J-2 presents the new Deer Island Treatment Plant process flow diagram.

Wastewater flows through the grit chambers for additional grit removal. It then flows to the primary settling tanks where floatables (consisting mainly of oil, grease and plastics) rise to the surface while the sludge (consisting of heavy solid particles) settles to the bottom. A portion of the primary effluent (the allowable capacity for secondary treatment) is sent to secondary treatment, while the remaining portion is sent directly to the disinfection basins to be treated with sodium hypochlorite. Effluent from secondary treatment is then sent to the disinfection basins, and is combined with the primary effluent.

The scum (floatables) is skimmed off the top of the primary and secondary settling tanks while the sludge (settled solids) is scraped from the bottom of the tanks. Scum is pumped to the scum concentrator while the sludge is pumped to the sludge thickeners. After the scum and sludge are concentrated and thickened, they are conveyed to the anaerobic digesters for further treatment. The digested sludge/scum is barged to the Fore River Pelletizing Plant, where it is converted into fertilizer.

Effluent is channeled through a common conduit to four potential outfall pipes, 001, 002, 004 and 005. Figure J-3 illustrates the Deer Island outfall schematics while Table J-3 presents the specifics of each outfall. Outfalls 001, 002 and 004 connect to Chamber C while outfall 005 connects to Chamber A. A sluice gate in Chamber A controls discharge from outfall 005. Likewise, a sluice gate in Chamber C isolates discharge from outfall 004. Of the five permitted outfalls, only outfalls 001 and 002 are used regularly. Outfall 004 is used only during high flow conditions, while relief outfall 005, although not generally used, can be activated during extremely high flows or emergency situations. Outfall 003 is permanently blocked and out of service.

The amount of wastewater that can be pumped to the plant is not only limited by sewer line capacity, treatment plant capacity and pumping capacity, but also by the outfall pipe capacity. The approximate amounts of treatment plant effluent that can be discharged through the outfalls are as follows:

Outfalls 001 & 002

High tide 400 mgd

Low tide 735 mgd

Outfalls 001 & 002 & 004

High tide 635 mgd

Low tide 900 mgd

Outfalls 001 & 002 & 004 & 005

High tide 900 mgd

Low tide 1,270 mgd

Table J-3 Deer Island Outfall Characteristics				
	Outfall Number			
	No. 001	No. 002	No. 004	No. 005
Length (ft.)	2260	2565	500	135
Discharge Elevation (ft.)	54.7	54.7	97.8	98
Number of Open Ports	14	47	1	1
Port Diameter (ft.)	1.67	1.69	9	9
Chamber Invert Elevation (ft.)	98.1	98.1	98.1	103.2
Chamber Overflow Elevation (ft.)	120	120	120	125
Pipe Size (in.) and Pipe Material	16 x 12 concrete to 12 x 10 concrete to 10 (diameter) reinforced concrete (RC)	6 x 6.25 to 9 (diameter) brick with concrete casing	9 (diameter) reinforced concrete (RC)	9 (diameter) reinforced concrete (RC)
Year Built	1896	1959	1959	1959

Figure J-2 Deer Island Treatment Plant Process

Population Served: 2.08 Million People. Average Design Flow: 480 MGD. Peak Design Flow: 1270 MGD
Current Operation - December, 1997

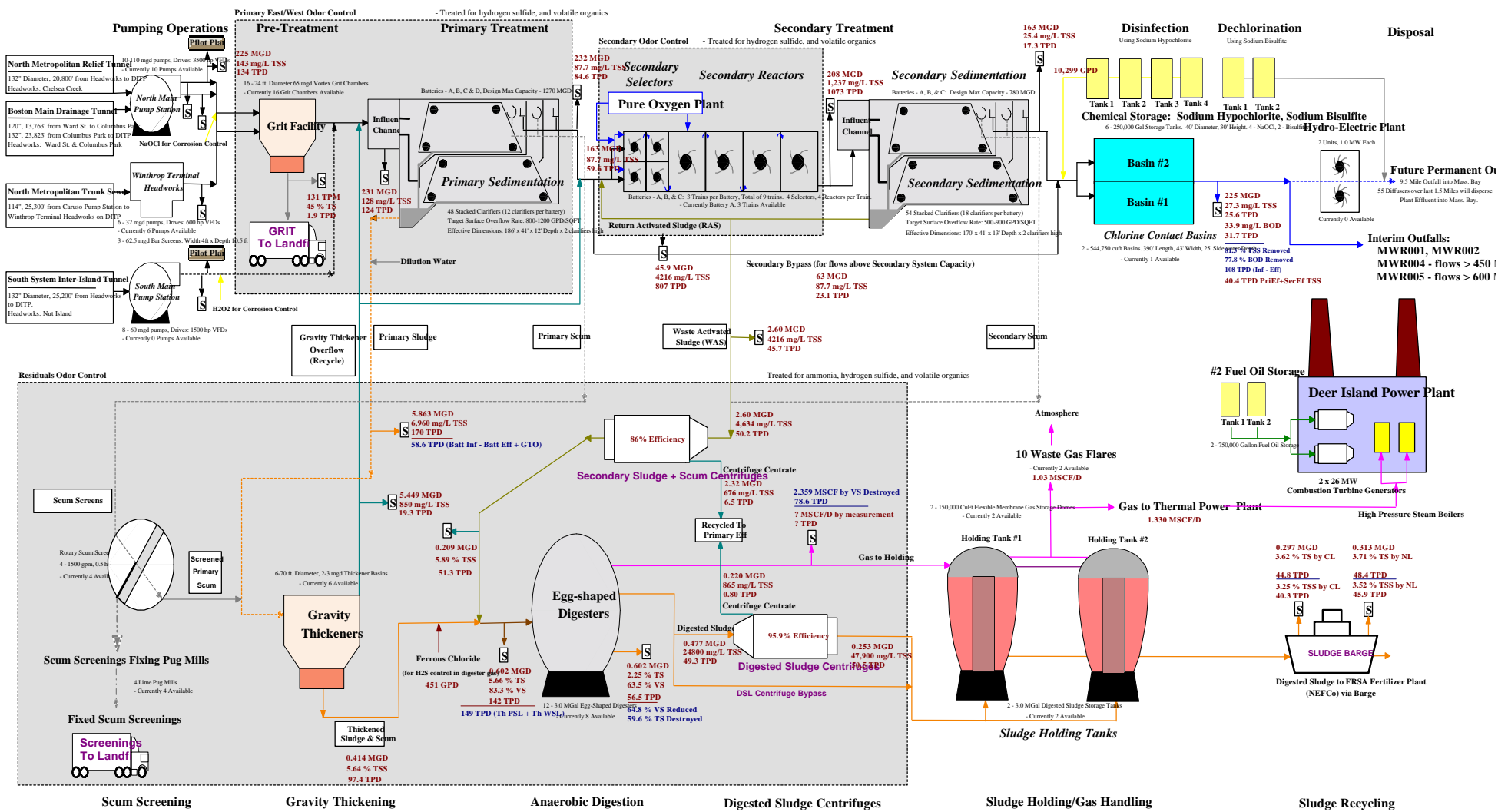

- Sample Withdrawal Point

Figure J-3
Deer Island Outfall System Schematic

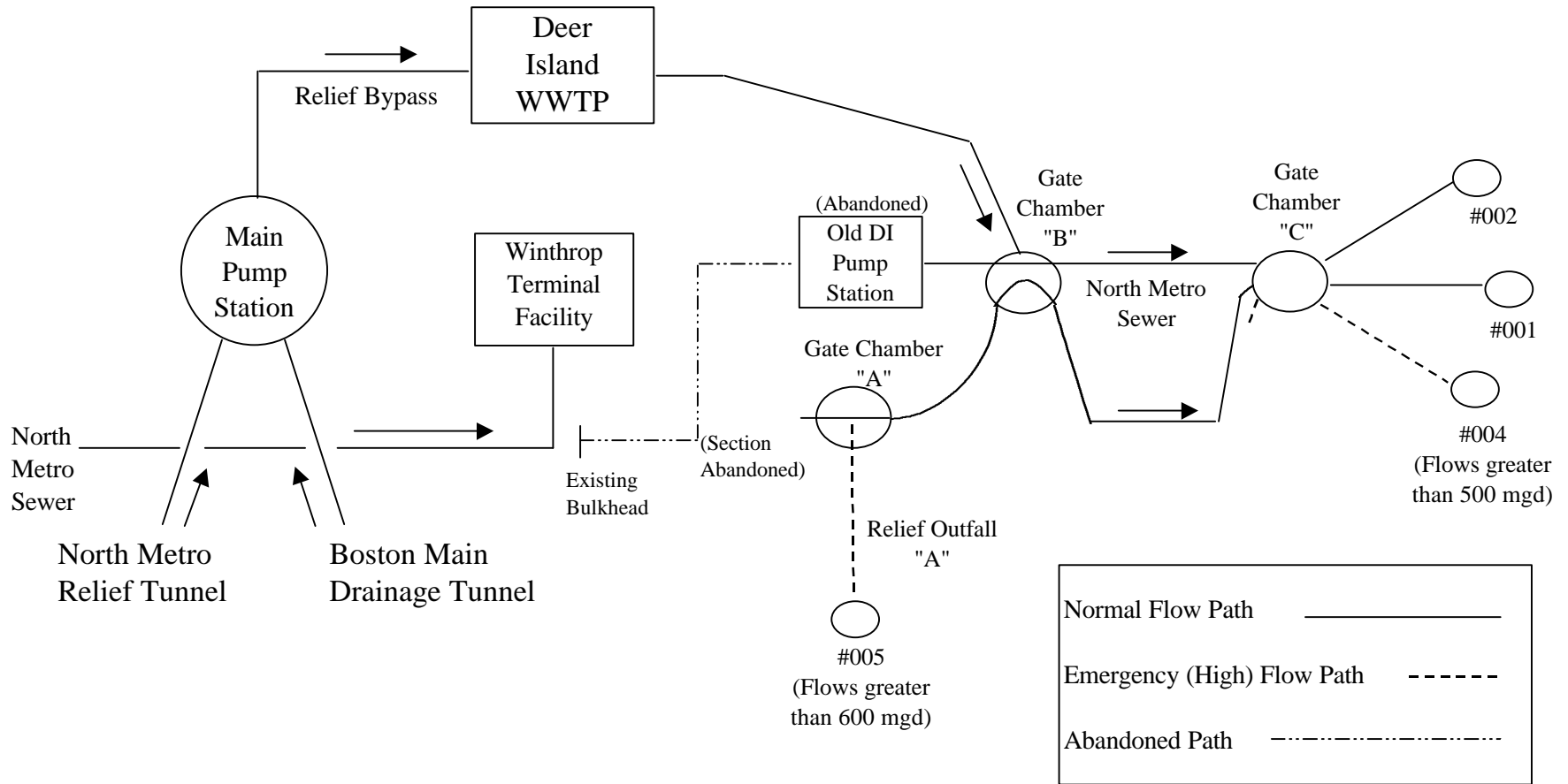

J.1.d Combined Sewer Overflow Facilities

The conditions for discharge of effluent from three CSO chlorination facilities are also included in MWRA's Boston NPDES permit. These three CSO chlorination facilities, Cottage Farm in Cambridge, Prison Point in Cambridge and Somerville Marginal in Somerville, discharge to the Charles River, the Inner Harbor and the Mystic River respectively. Three other CSO chlorination facilities, Constitution Beach in East Boston, Fox Point in Dorchester and Commercial Point in Dorchester, are owned and operated by MWRA. Effluent from these three facilities discharges to Boston Water and Sewer Commission (BWSC) lines and is included in the BWSC NPDES permit.

Discharge of combined wastewater from a CSO treatment facility to a receiving body of water is defined in this report as a CSO activation. Discharge of combined wastewater to a CSO outfall pipe is defined as a CSO overflow. CSO overflows will not be discussed in this report. In general, CSO activations occur as a result of heavy rain, snowmelt, or choking at the headworks. Choking is the process by which the headworks restrict the flow to Deer Island. During wet weather, when the wastewater volume exceeds the hydraulic capacity of the treatment plant, the headworks "chokes" the flow and holds the wastewater in the lines. As a result, the combined wastewater backs up into the system, forcing the combined wastewater to overflow to CSO treatment facilities and CSO outfall pipes, resulting in potential CSO activations and overflow.

In addition to choking in response to hydraulic demand on the system, the headworks may choke to perform emergency repairs, system testing, or maintenance work at the treatment plant. Choking at Ward Street and Columbus Park Headworks influences Cottage Farm activations. Choking at the Columbus Park Headworks influences activations at the Fox Point and Commercial Point CSO facilities. Backups at the DeLauri Pumping Station brought about by choking at the Chelsea Headworks activate the Somerville Marginal CSO facility.

At a CSO facility, the combined wastewater is chlorinated prior to discharge. Of the six CSO facilities, only Cottage Farm and Prison Point have pumping and tank storage capacity. This allows for chlorinated wastewater to be held at these facilities prior to discharge. When the CSO facility's

storage capacity is exceeded, treated wastewater overflows and is discharged to the river. The four other CSO facilities are gravity CSO facilities, which means that combined wastewater arrives and leaves the CSO facility by gravity. This type of facility provides disinfection and allows the chlorinated combined wastewater to overflow to the receiving water as quickly as the wastewater arrives at the facility. Figure J-4 is a schematic of a typical gravity CSO treatment facility.

The six CSO facilities provide treatment for approximately 50% of the CSO volume while the other half overflows in any of the 85 permitted CSO overflow structures of the sewerage system without the benefit of any type of treatment. Of the 85 permitted CSO overflow structures, 53 are located in Boston, 15 in Cambridge, 5 in Chelsea and 12 in Somerville. These outfalls discharge into Boston Harbor, the Alewife Brook, the Mystic River, the Charles River and the Neponset River.

Prison Point Combined Sewer Overflow Facility

Prison Point is a both dry weather and stormwater pumping station. The dry weather phase is a five-mgd capacity sewer pumping station that receives flow from the Boston Marginal Conduit and the Cambridge Marginal Conduit. Prison Point feeds into the DeLauri Pumping Station.

The stormwater phase has a maximum pumping capacity of 385 mgd. Treatment includes screening, disinfection and detention. During wet weather, if the dry pumping capacity is exceeded, the combined flow is screened, chlorinated, and held in detention basins. Once the basins fill, treated flow is discharged downstream below the new Charles River Dam at outfall MWR203. Combined wastewater volume that is held back (up to 1.2 mgd) is pumped back to the DeLauri Station. This facility came on-line in 1980.

Cottage Farm Combined Sewer Overflow Facility

Cottage Farm, like Prison Point, is a two-phase facility. During dry weather conditions, wastewater arrives at the Ward Street Headworks where it is pumped to the Deer Island Plant. Under storm conditions, wastewater backs up into sewer lines and into the Cottage Farm CSO facility. Cottage Farm detains wastewater up to a volume of 1.3 MG. Any excess flow is screened, settled, chlorinated

and discharged to the Charles River through outfall MWR201. Combined wastewater that is held back is pumped back to the Ward Street Headworks. This facility, on-line since 1971, has a design pumping capacity of 233 mgd.

Somerville Marginal Combined Sewer Overflow Facility

Somerville Marginal CSO is an unmanned gravity facility with a design capacity of 245 mgd. It receives wet weather flow from the northeast portion of Somerville and part of Medford. Normally, dry weather flow from these areas arrives at the DeLauri Station via the Somerville-Medford trunk sewers. During wet weather, combined sewer flow backs up to the Somerville CSO facility. Unlike Cottage Farm or Prison Point, this facility does not provide any detention capacity during storm conditions. Treatment consists of screening and chlorination. Effluent is discharged to the lower Mystic River basin at outfall number MWR205. During low-intensity rainfall when line capacity is not exceeded, the combined wastewater is pumped back from a wet well to the DeLauri Station. This facility came on-line in 1973 and was upgraded in 1988.

Constitution Beach Combined Sewer Overflow Facility

Constitution Beach is an unmanned gravity facility with a design capacity of 20 mgd. It receives flows from the North Metro Trunk sewer. Treatment consists of screening and disinfection. Effluent is discharged to a BWSC line that ultimately discharges to Boston Harbor through outfall number BOS002. This outfall is included in the BWSC permit. Since the issuance of that permit, full ownership of the Constitution Beach CSO facility has been transferred to MWRA. This facility came on-line in 1987.

Figure J-4
Combined Sewer Overflow Treatment Facility

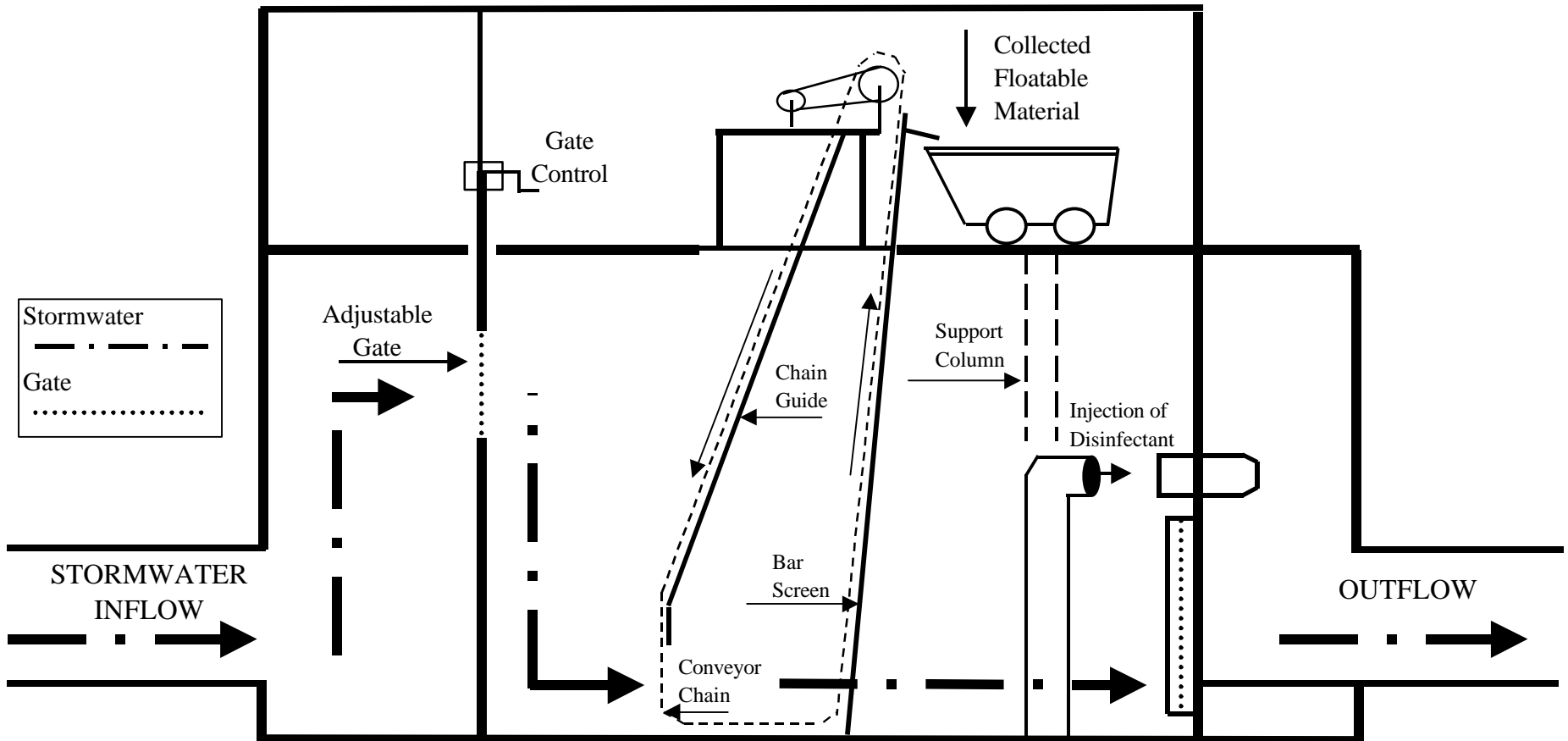

Fox Point Combined Sewer Overflow Facility

Fox Point has a design capacity of 119 mgd. It receives wet weather flows from the Dorchester Interceptor sewer line. Operation of this facility parallels that of the Constitution Beach CSO facility; treatment includes screening and disinfection. Effluent is discharged to a BWSC sewer line that discharges to Dorchester Bay through outfall number BOS089. This outfall is included in the BWSC permit. This facility came on-line in 1989.

Commercial Point Combined Sewer Overflow Facility

Commercial Point is an unmanned gravity CSO with a design capacity of 194 mgd. This facility also receives wet weather backups from the Dorchester Interceptor. Treatment includes screening and disinfection. Effluent is discharged to a BWSC line that ultimately discharges to Dorchester Bay through outfall number BOS090. This outfall is included in the BWSC permit. This facility came on-line in 1991.

J.2 South System

The South System serves a population of about 700,000 people and is located to the south and southwest of Boston. Figure J-5 illustrates the South System schematics. Community sewer lines tie into the South System through MWRA interceptor lines. The Framingham Extension Sewer, Wellesley Extension Sewer, Upper Neponset Valley Sewer, Wellesley Extension Relief Sewer, Neponset Valley Sewer, Walpole Extension Sewer, Stoughton Extension Sewer, Braintree-Randolph Trunk Sewer and several other branch sewers discharge to the High Level Sewer. Pump stations move the wastewater through the High Level Sewer to Nut Island Treatment Plant.

Beginning in FY99, there will be no primary treatment of sewage at the Nut Island Plant. Rather, all of the South System flows will be screened at the Nut Island Headworks and then sent to Deer Island (via the new Inter-Island Tunnel) for secondary treatment.

Figure J-5
South System Hydraulic Schematic

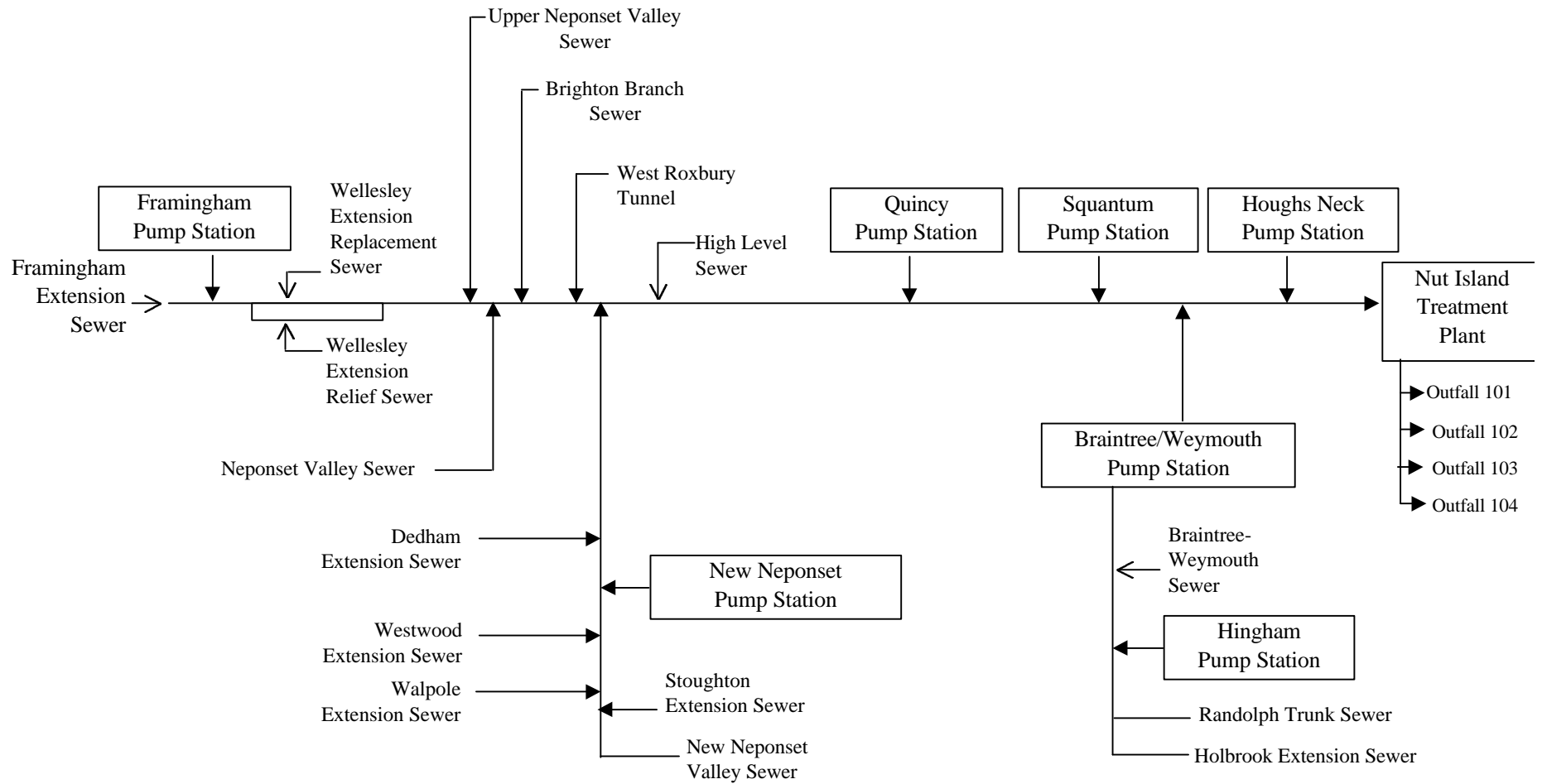

J.2.a Pump Stations

Seven MWRA pump stations move wastewater from low-lying areas to the High Level Sewer: Hingham Pump Station (16.5 mgd), Braintree-Weymouth Pump Station (60 mgd), Squantum Pump Station (12 mgd), Houghs Neck Pump Station (2.8 mgd), Neponset Lift Station (90 mgd), Framingham Pump Station (48 mgd) and Quincy Pump Station (52 mgd). The high level sewer conveys wastewater to the Nut Island Treatment Plant.

The seven pumping stations receive flow from interceptor or community lines as follows:

Hingham Pump Station	Weymouth-Hingham Sewer Lines
Braintree-Weymouth Pump Station	Braintree-Randolph Trunk Sewer Braintree-Weymouth Extension Sewer Holbrook Extension Sewer Hingham Pumping Station
Squantum Pump Station	Squantum Sewers
Houghs Neck Lift Station	Houghs Neck Sewer
Neponset Pump Station	Neponset Valley Sewer
Framingham Pump Station	Framingham Sewers
Quincy Pump Station	Quincy and Upstream Sewers

J.2.b Nut Island Treatment Plant

The Nut Island Treatment Plant, in operation since 1952, serves 17 communities in the southern portion of the sewerage system and parts of Boston, Brookline, Newton and Milton, for a total of 21 communities. The area served by Nut Island is approximately 238 square miles. The Nut Island Treatment Plant was designed to provide primary treatment for an average daily flow of 112 mgd and a peak flow of 230 mgd. In FY98, the last stages of construction of the new Nut Island Headworks site were completed. The Nut Island Headworks will start up in early FY99. Also in FY99, the Nut Island Treatment Plant will be decommissioned, and all South System flows will be treated at Deer Island. To prepare for and test the new procedure, portions of Nut Island effluent were sent to the Deer Island Treatment Plant during the last three months of FY98.

Figure J-6 presents the current Nut Island process flow diagram. Current Nut Island treatment processes include:

- screening and grit removal
- preaeration
- primary settling
- disinfection
- anaerobic digestion.

Nut Island consists of two bar screens, six grit chambers, five preaeration tanks, six sedimentation tanks and four digesters. Wastewater entering Nut Island passes through bar screens and grit chambers. Grit and screenings are sent to a landfill. Wastewater is pumped to the preaeration channels and then flows by gravity through the sedimentation tanks. Scum is skimmed off the top and sent to a landfill. Sludge is scraped from the bottom and pumped to the anaerobic digesters for further treatment. The digested sludge is barged to the Fore River Pelletizing Plant where it is converted to fertilizer. Effluent is disinfected with chlorine gas prior to discharge through outfalls that discharge to Nantasket Roads Channel in Boston Harbor and Hingham Bay.

The Nut Island outfall system consists of four outfalls. The three main outfalls, designated 101, 102 and 103, are each five feet in diameter but of varying lengths. Outfalls 101 and 102 are used on a daily basis, while Outfall 103 is used during conditions of higher flow. Outfall 104 is used only

during extreme high tide conditions (el. 115.7) and plant inflows approaching 230 mgd. Outfalls 101, 102 and 103 discharge to Boston Harbor. Outfall 104, used to handle flow in excess of the capacity of the three main outfalls, discharges to Hingham Bay.

The amount of wastewater that can be pumped to the plant is not only limited by sewer line capacity, treatment plant capacity and pumping capacity, but also by the outfall pipe capacity. Figure J-7 shows the Nut Island outfall system schematic while Table J-4 lists pertinent information about the Nut Island outfalls.

The approximate amounts of treatment plant effluent that can be discharged through the outfalls are estimated as follows:

Outfalls 101 & 102
 High tide 105 mgd
 Low tide 150 mgd

Outfalls 101, 102, & 103
 High tide 166 mgd
 Low tide 245 mgd

Outfalls 101, 102, 103 & 104
 High tide 245 mgd
 Low tide 260 mgd

Table J-4 Nut Island Outfall Characteristics				
	Outfall Number			
	No. 101	No. 102	No. 103	No. 104
Length (ft.)	5830	5545	1412	663
Port Diameter (in.)	60	60	60	60
Pipe Material	Cast iron	Cast iron	Cast iron	Reinforced concrete (RC)
Year Built	1904		1904	

Figure J-6
Nut Island Wastewater Treatment Plant Flow Diagram

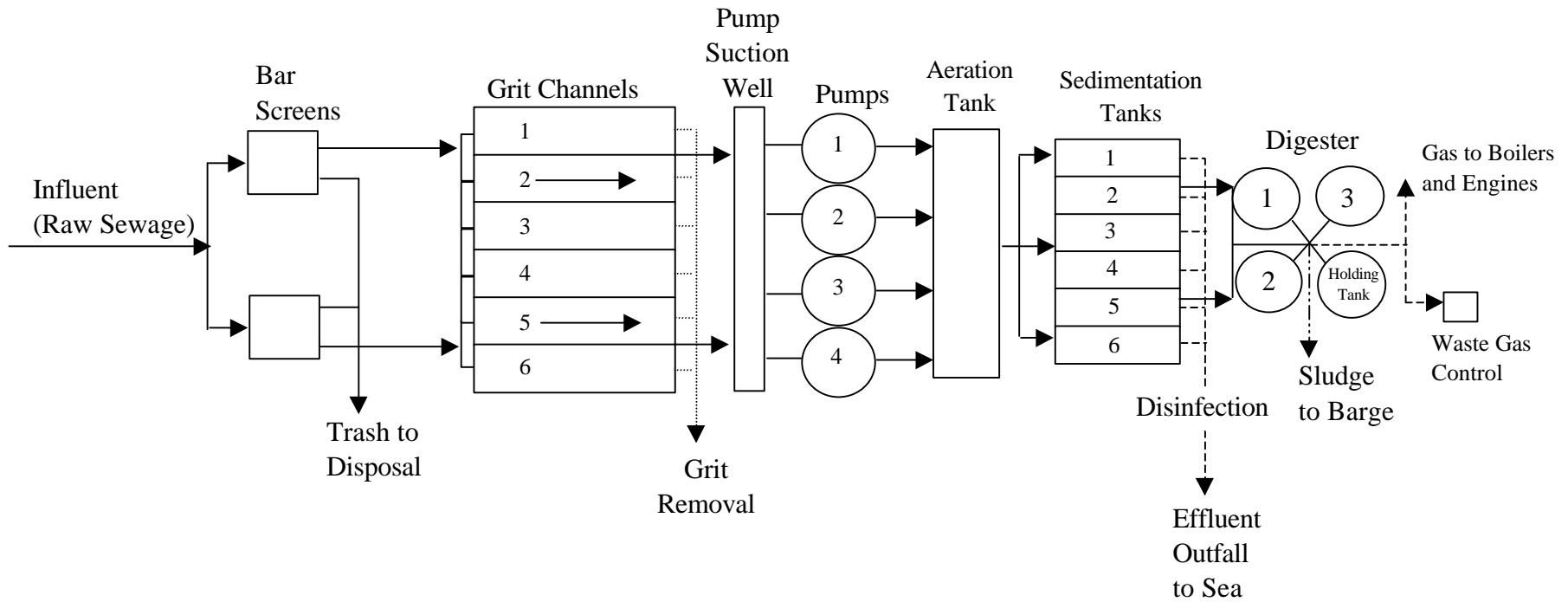
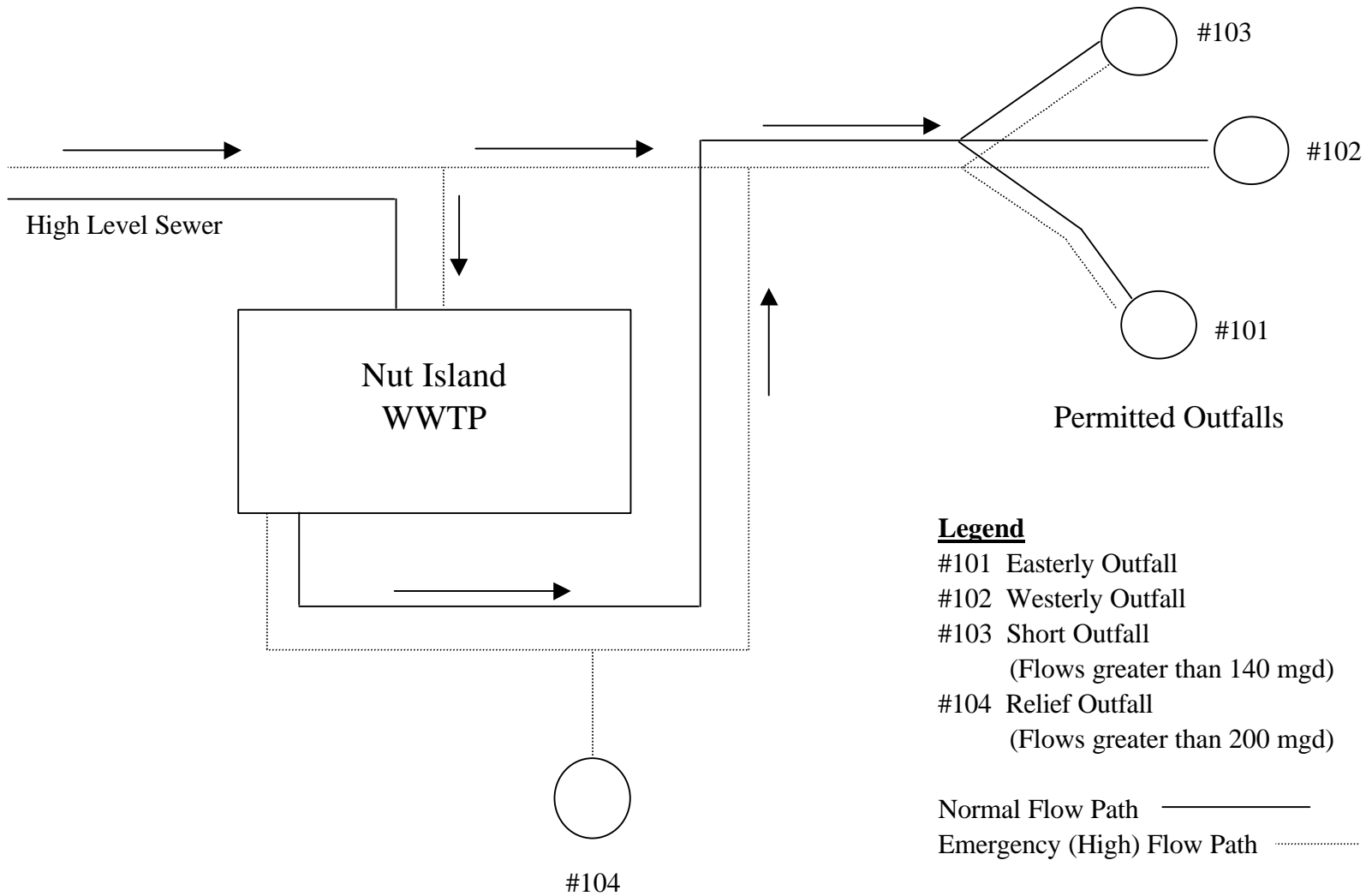

Figure J-7
Nut Island Outfall System Schematic



J.3 Sanitary Sewer Overflows

An issue of concern in both the North System and the South System is the occurrence of Sanitary Sewer Overflows (SSOs). These occur during extreme rainfall events, when the combined wastewater and stormwater flows exceed the capacity of the pipes and cause certain areas to become inundated. As a matter of course, whenever there is a high amount of rainfall, a crew from the Transport Department investigates a number of critical areas to visually monitor overflows. While some of these critical areas are MWRA's responsibility, most of them are the responsibility of the local communities. A list of these areas and who is responsible for them is included in Table J-5. Not all of these areas are checked during every rainfall, and some are monitored by MWRA only during extreme storm events.

Table J-5 MWRA Sewer System Overflow Locations

<u>Number</u>	<u>Owner</u>	<u>Location and Description</u>
1	MWRA ^{1,3}	Section 107 (Overflow Relief Point) Medford, On Median Strip of On Ramp to Rt. 16
2	MWRA ¹	Section C (Overflow Relief Point) Medford, Auburn St. at Rt. 16
3	MWRA ¹	Section 91B (Siphon) Medford, Lakeview Ter. At Mystic Valley Pkwy
4	MWRA ^{1,3}	Section 91B (Manhole) Medford, Lakeview Ter.
5	MWRA ^{2,3}	Section 126 (Siphon) Braintree, Easement between Commercial St. & Quincy Ave.
6	MWRA ^{2,3}	Section 126 (Manhole) Braintree, Idlewell Blvd.
7	MWRA ²	Section 128 (Siphon) Braintree, Pearl St.
8	MWRA ²	Norwood, Manhole
9	MWRA ²	Weymouth, Manhole, Regina Rd.
10	Newton	Manhole, 100 Peregrine Rd.
11A	Roslindale	Manhole, Florence St. Sycamore St.
11B	Roslindale	Manhole, Sammett Ave. Mt. Hope Rd. Holly St.
11C	Roslindale	Manhole, Archdale St.
12	Everett	Manhole, Preston St.
13	Malden	Manhole, Taylor St.
14	Medford	Manhole, Roosevelt St.
15	Medford	Manhole, Mystic Ave.
16	Arlington	Manhole, Kimball Rd.
17	Arlington	Manhole, Summer St.
18	Quincy	Manhole, 40 Willard St.
19	W. Roxbury	Manhole, 307 V.F.W. Parkway
20	Hyde Park	Manhole, Clark Ave. American Legion Hwy.
21	Arlington	Manhole, 22 Grove St.
22	Weymouth	Manhole, 159 Spring Way
23	Hyde Park	Manhole, 46 Collins St.
24	Hyde Park	Manhole, 45 Sierra St.
25	Braintree	Manhole, 16 Allen St.
26	Newton	Manhole, 183 Old Farm Rd.

Table J-5 MWRA Sewer System Overflow Locations (continued)

<u>Number</u>	<u>Owner</u>	<u>Location and Description</u>
27	Arlington	Section 80 (Overflow Relief Point) Behind Brattle Court Pumping Station
28	Arlington	Section 80 (Overflow Relief Point) Hobbs Court Plug- Temporary
29	Medford	Section 43.5 (Overflow Relief Point) Boston Ave. At Rt. 16
30	Cambridge	Section B (Overflow Relief Point) Alewife Brook at T-Station
31	Malden	Section 19 (Overflow Relief Point) Off Commercial Street at Malden River
32	Winchester	Section 113 (Siphon) Wedgemere Siphon
33	Natick	Section 132 (Siphon) Eliot St.
34	Norwood	Section 117 (Siphon and Manhole) Wooded Area at Neponset River
35	Canton	Section 121 (Manhole) Wooded Area at Steep Hill Brook Neponset River
36	Norwood	Manhole, New Walpole Extension Sewer Behind Overlook Dr.

¹ North System

² South System

³ Active during severe storms in conjunction with high ground water and limited capacity

Appendix K

Instrument Detection Limits, Method Detection Limits, and Quantitation Limits: A Brief Description

An understanding of the detection limits of analysis is essential to reviewing the data from chemical analyses. There are three different types of detection limits that are most often encountered:

- **Instrument Detection Limits**
- **Method Detection Limits**
- **Quantitation Limits**, also known as **Reporting Limits**.

Instrument detection limits (IDL) reflect the capability of the instrument, such as the Gas Chromatograph (GC), used to conduct the analysis. This will be the lowest of the three detection limits. The IDL will not take into account the losses of the pollutant associated with the matrix (soil or wastewater) and extraction procedure. This discrepancy is known as matrix interference.

Method detection limits (MDL) are the smallest amount of a substance that can be detected above background noise using a particular method. The MDL is statistically determined by running a series of analyses using various low concentrations of a pollutant. Using a Student's "T" test, the smallest concentration that has a 99% probability of being detected above the background is designated the MDL for that pollutant. The EPA, using several private laboratories, has determined what the MDLs are for most priority pollutants using their detailed methods. These are published in the 40 CFR and some are listed in Table L-1 of Appendix L of this report.

In general, if a plot is made of pollutant concentration versus instrument response, it will generate a linear relationship. As the pollutant concentration approaches zero, the linearity of the relationship is lost. At the point where the linearity is lost is the **Quantitation Limit (QL)**, or sometimes the **Reporting Limit**. In other words, the smallest concentration where the linear relationship holds is

the smallest concentration that can be quantified. Generally, the QL is about five times the MDL. Quantitative limits are relevant to GC/MS analyses, that is, methods 608 (for pesticides), 624 (for volatile organics), and 625 (for semi-volatile organics). Specific limits are highly matrix-dependent.

The EPA has developed **Contract Required Quantitation Limits (CRQL)**, which serve as a guideline for selecting contract laboratories to perform analyses. Some CRQLs are listed in Table L-1 of this report.

In short, the IDL is the lowest concentration that a particular instrument can detect. The MDL is the lowest concentration that can be detected using a particular method. The QL is the smallest concentration that can be confidently considered to be accurate.

Reported concentrations that are between the MDL and the QL indicate that a pollutant is present, but at a concentration too low to be accurately quantified. For example, using EPA method 624, chloroform has an MDL of 1.6 µg/L and a QL of 10 µg/L. If the concentration from an analysis is reported as 5 µg/L then it can be inferred that although the actual chloroform concentration in the wastewater is uncertain, 5 µg/L is a best guess. The EPA requires that these intermediate values be flagged with a “J” on any reports submitted to them. Therefore, these are sometimes simply called “J-values.”

For non-detects in analyses of metals, cyanide, petroleum hydrocarbons, etc., it is customary for “less than the MDL” to be listed as a result. For a non-detect in the 608, 624, and 625 analyses, “less than the QL” is typically listed.

Often it becomes necessary to estimate a concentration for below detection limit values, specifically when calculating the average yearly concentration of a pollutant. A well established method is to assume the actual concentration of a non-detected pollutant is simply one half of the MDL. While no scientific theory supports this assumption, it is more reasonable than assuming that the

concentration is zero, or the MDL itself. It is also accepted by the EPA and DEP as a standard practice that can be applied to any series of tests.

This technique is utilized in this report. For the organic compounds – methods 608, 624, and 625 – one tenth of the QL, or half the MDL, was assumed for all non-detects (i.e. values below QL). For all metals, cyanide, petroleum hydrocarbons, etc., half the MDL was assumed for all non-detects (i.e. values below MDL).

In Appendix L, Table L-1 is a list of the parameters regularly tested for in MWRA effluent. The required EPA method is referenced by its number and the recommended EPA detection limit is provided. The CRQL is also provided when applicable. These limits are compared to the detection levels normally attained by the contract laboratory analyzing MWRA effluent.

Appendix L

Priority Pollutants and Other Parameters

Table L-1 List of Parameters Tested

Table L-2 EPA List of 126 Priority Pollutants

Table L-3 NPDES Permit Testing Requirements, 40 CFR 122, Appendix D, Tables I and II

Table L-1 List of Parameters Tested

(Influent and Effluent)*

	EPA Method Number	EPA MDL	CRQL	Contract Lab MDL	Contract Lab QL
METALS					
Antimony	204.2	3.0	NA	5.0	NA
Arsenic	206.2	1.0	NA	2.0	NA
Beryllium	200.7	0.3	NA	1.0	NA
Cadmium	213.2	0.1	NA	1.0	NA
Chromium	218.2	1.0	NA	5.0	NA
Copper	200.7	6.0	NA	4.0	NA
Lead	239.2	1.0	NA	1.5	NA
Mercury	245.1	0.2	NA	0.2	NA
Nickel	200.7	15.0	NA	12.0	NA
Selenium	270.2	2.0	NA	2.0	NA
Thallium	279.2	1.0	NA	2.0	NA
Zinc	200.7	2.0	NA	10.0	NA
Boron	200.7	5.0	NA	30.0	NA
Molybdenum	246.2	1.0	NA	8.0	NA
Silver	272.2	0.2	NA	3.0	NA
OTHER INORGANIC CHEMICALS **					
Cyanide	335.2	20.0	NA	10.0	NA
Hexavalent Chromium	307 B	10.0	NA	5.0	NA
Oil & Grease (mg/L)	413.1	5.0	NA	5.0	NA
Petroleum Hydrocarbons (mg/L)		1.0	NA	1.0	NA
Surfactants (mg/L)		25.0	NA	25.0	NA
PESTICIDES					
	608			NA	
alpha-BHC		0.003	0.05		0.05
beta-BHC		0.006	0.05		0.05
delta-BHC		0.009	0.05		0.05
gamma-BHC (Lindane)		0.004	0.05		0.05
Heptachlor		0.003	0.05		0.05
Aldrin		0.004	0.05		0.05
Heptachlor epoxide		0.083	0.05		0.05
Endosulfan I		0.014	0.05		0.05
Endrin aldehyde		0.023	0.10		0.10
Dieldrin		0.002	0.10		0.10
4,4'-DDE		0.004	0.10		0.10
Endrin		0.006	0.10		0.10
Endosulfan II		0.004	0.10		0.10
4,4'-DDD		0.011	0.10		0.10
Endosulfan sulfate		0.066	0.10		0.10
4,4'-DDT		0.012	0.10		0.10
Methoxychlor			0.50		0.50

Table L-1 List of Parameters Tested [cont.]

(Influent and Effluent)*

	EPA Method Number	EPA MDL	CRQL	Contract Lab MDL	Contract Lab QL
Toxaphene		0.240	0.50		5.00
Chlordane		0.014	1.00		1.00
PCBs					
Aroclor-1016		ND	2.00		2.00
Aroclor-1221		ND	1.00		1.00
Aroclor-1232		ND	1.00		1.00
Aroclor-1242		0.065	1.00		1.00
Aroclor-1248		ND	1.00		1.00
Aroclor-1254		ND	1.00		1.00
Aroclor-1260		ND	0.05		0.20
VOLATILE ORGANICS	624				
Chloromethane		ND	10		10
Bromomethane		ND	10		10
Vinyl chloride		ND	10		10
Chloroethane		ND	10		10
Methylene chloride		2.8	10		10
Acetone			10		10
Carbon disulfide			10		10
1,1-dichloroethylene		2.8	10		10
1,1-dichloroethane		4.7	10		10
1,2-dichloroethylene		1.6	10		10
Chloroform		1.6	10		10
Methylethyl ketone (2-butanone)			10		10
1,2-dichloroethane		2.8	10		10
1,1,1-trichloroethane		3.8	10		10
Carbon tetrachloride		2.8	10		10
Vinyl acetate			10		10
Bromodichloromethane		2.2	10		10
1,2-dichloropropane		6.0			10
Cis 1,3 dichloropropene		5.0	10		10
Trichloroethylene		1.9	10		10
Chlorodibromomethane		3.1	10		10
1,1,2-trichloroethane		5.0	10		10
Benzene		4.4	10		10
Trans-1,3-dichloropropene		ND	10		10
Bromoform		4.7	10		10
4-methyl-2-pentanone			10		10
2-hexanone			10		10
Tetrachloroethylene		4.1	10		10
1,1,2,2-tetrachloroethane		6.9	10		10
Toluene		6.0	10		10

Table L-1 List of Parameters Tested [cont.]

(Influent and Effluent)*

	EPA Method Number	EPA MDL	CRQL	Contract Lab MDL	Contract Lab QL
Chlorobenzene		6.0	10		10
Ethylbenzene		7.2	10		10
Styrene			10		10
Xylene (Total)			10		10
2-chloroethylvinylether			10		10
Volatile Organics (cont)					
Trichlorofluoromethane			10		10
Acrolein			10		10
Acrylonitrile			10		10
SEMI-VOLATILES	625				
Phenol		1.5	10		10
Bis (2-chloroethyl) ether		5.7	10		10
2-chlorophenol		3.3	10		10
m-dichlorobenzene		1.9	10		10
p-dichlorobenzene		1.9	10		10
o-dichlorobenzene		1.9	10		10
o-cresol			10		10
2,2'oxybis (1-chloropropane)		5.7	10		10
p-cresol			10		10
N-nitroso-di-n-propylamine		ND	10		10
Hexachloroethane		1.6	10		10
Nitrobenzene		1.9	10		10
Isophrone		2.2	10		10
o-nitrophenol		3.6	10		10
2,4-dimethylphenol		2.7	10		10
Bis (2-chloroethoxy)methane		5.3	10		10
2,4-dichlorophenol		2.7	10		25
1,2,4-trichlorobenzene		1.9	10		10
Naphthalene		1.6	10		10
p-chloroaniline			10		10
Hexachlorobutadiene			10		10
p-chloro-m-cresol			10		10
2-methylnaphthalene			10		10
Hexachlorocyclopentadiene		ND	10		10
2,4,6-trichlorophenol		2.7	10		10
2,4,5-trichlorophenol			25		25
2-chloronaphthalene		1.9	10		10
o-nitroaniline			25		25
Dimethyl phthalate		1.6	10		10
Acenaphthylene		3.5	10		10
2,6-dinitrotoluene		1.9	10		10
m-nitroaniline			25		25

Table L-1 List of Parameters Tested [cont.]

(Influent and Effluent)*

	EPA Method Number	EPA MDL	CRQL	Contract Lab MDL	Contract Lab QL
Acenaphthene		1.9	10		10
2,4-dinitrophenol		42.0	25		25
p-nitrophenol		3.6	25		25
Dibenzofuran			10		10
2,4-dinitrotoluene		5.7	10		10
Diethyl phthalate		1.9	10		10
4-chlorophenyl phenyl ether		4.2	10		10
Fluorene		1.9	10		10
Semivolatiles (Cont)					
p-nitroaniline			25		25
4,6-dinitro-o-cresol			10		10
N-nitrosodiphenylamine		1.9	10		10
4-bromophenyl phenyl ether		1.9	10		10
Hexacholobenzene		1.9	10		10
Pentachlorophenol		3.6	25		10
Phenanthrene		5.4	10		10
Anthracene		1.9	10		10
Di-n-butyl phthalate		2.5	10		10
Fluoranthene		2.2	10		10
Pyrene		1.9	10		10
Butyl benzyl phthalate		2.5	10		10
3,3'dichlorobenzidene		16.5	10		10
Benzo(a)anthracene		7.8	10		10
Chrysene		2.5	10		10
Bis (2-ethylhexyl) phthalate		2.5	10		10
Di-n-octyl phthalate		2.5	10		10
Benzo(b)fluoranthene		4.8	10		10
Benzo(k)fluoranthene		2.5	10		10
Benzo(a)pyrene		2.5	10		10
Indeno(1,2,3-cd)pyrene		3.7	10		10
Dibenz(a,h)anthracene		2.5	10		10
Benzo(ghi)perylene		4.1	10		10
Benzoic acid			10		10
Benzyl alcohol		ND	10		10
Benzidene		44	10		10
1,2-diphenylhydrazine			10		10
N-nitrosodimethylamine		ND	10		10

* Pollutants analyzed in addition to influent and effluent analyses of conventional pollutants listed in Appendix A, Table A-1. All units expressed in µg/L unless otherwise noted.

** Units expressed in mg/L.

ND - Not determined by EPA.

NA - Not Applicable.

Table L-2 EPA List of 126 Priority Pollutants

Chlorinated Benzenes

Chlorobenzene
1,2-dichlorobenzene
1,3-dichlorobenzene
1,4-dichlorobenzene
1,2,4-trichlorobenzene
Hexachlorobenzene

Chlorinated Ethanes

Chloroethane
1,1-dichloroethane
1,2-dichloroethane
1,1,1-trichloroethane
1,1,1,2-tetrachloroethane
Hexachloroethane

Chlorinated Phenols

2-chlorophenol
2,4-dichlorophenol
2,4,6-trichlorophenol
Parametachlorocresol (4-chloro-3-methyl phenol)

Other Chlorinated Organics

Chloroform (trichloromethane)
Carbon tetrachloride (tetrachloromethane)
Bis(2-chloroethoxy)methane
Bis(2-chloroethyl)ether
2-chloroethyl vinyl ether (mixed)
2-chloronaphthalene
3,3-dichlorobenzidine
1,1-dichloroethylene
1,2-trans-dichloroethylene
1,2-dichloropropane
1,2-dichloropropylene (1,3-dichloropropene)
Tetrachloroethylene
Trichloroethylene
Vinyl chloride (chloroethylene)
Hexachlorobutadiene
Hexachlorocyclopentadiene
2,3,7,8-tetrachloro-dibenzo-p-dioxin (TCDD)

Haloethers

4-chlorophenyl phenyl ether
2-bromophenyl phenyl ether
Bis(2-chloroisopropyl) ether

Halomethanes

Methyl chloride (dichloromethane)
Methyl chloride (chloromethane)
Methyl bromide (bromomethane)
Bromoform (tribromomethane)
Dichlorobromomethane
Chlorodibromomethane

Nitroamines

N-nitrosodimethylamine
N-nitrosodiphenylamine
N-nitrosodi-n-propylamine

Phenols (other than chlorinated)

2-nitrophenol
4-nitrophenol
2,4-dinitrophenol
4,6-dinitro-o-cresol (4,6-dinitro-2-methylphenol)
Pentachlorophenol
Phenol
2,4-dimethylphenol

Phthalate Esters

Bis(2-ethylhexyl)phthalate
Butyl benzyl phthalate
Di-N-butyl phthalate
Di-n-octyl phthalate
Diethyl phthalate
Dimethyl phthalate

Polynuclear Aromatic Hydrocarbons (PAHs)

Acenaphthene
1,2-benzanthracene (benzo (a)
anthracene)
Benzo(a)pyrene (3,4-benzo-pyrene)
3,4-benzofluoranthene (benzo(b)
fluoranthene)
11,12-benzofluoranthene (benzo(k)
fluoranthene)
Chrysene
Acenphthalene
Anthracene
1,12-benzoperylene (bonze(ghi)
perylene)
Fluorene
Fluoranthene
Phenanthrene
1,2,5,6-dibenzanthracene
(dibenzo(a,h)anthracene)
Indeno (1,2,3-cd) pyrene (2,3-o-
phenylene pyrene)
Pyrene

Pesticides and Metabolites

Aldrin
Dieldrin
Chlordane (technical mixture and
metabolites)
Alpha-endosulfan
Beta-endosulfan
Endosulfan sulfate
Endrin
Endrin aldehyde
Heptachlor
Heptachlor epoxide (BHC-
hexachlorocyclohexane)
Alpha-BHC
Beta-BHC
Gamma-BHC (Lindane)
Delta-BHC
Toxaphene

DDT and Metabolites

4,4-DDT
4,4-DDE (p,p-DDX)
4,4-DDD (p,p-DDE)

Polychlorinated Biphenyls (PCBs)

PCB-1242 (Arochlor 1242)
PCB-1254 (Arochlor 1254)
PCB-1221 (Arochlor 1221)
PCB-1232 (Arochlor 1232)
PCB-1248 (Arochlor 1248)
PCB-1260 (Arochlor 1260)
PCB-1016 (Arochlor 1016)

Other Organics

Acrolein
Acrylonitrile
Benzene
Benzidine
2,4-dinitrotolulene
2,6-dinitrotolulene
Ethylbenzene
Isophorone
Naphthalene
Nitrobenzene
Tolulene

Inorganics

Antimony
Arsenic
Asbestos
Beryllium
Cadmium
Chromium (III)
Chromium (VI)
Copper
Cyanide, total
Lead
Mercury
Nickel
Selenium
Silver
Thallium
Zinc

Table L-3
NPDES Permit Application Testing Requirements,
40 CFR 122, Appendix D, Tables II and III

Organic Toxic Pollutants

Volatiles

acrolein
 acrylonitrile
 benzene
 bromoform
 carbon tetrachloride
 chlorobenzene
 chlorodibromomethane
 chloroethane
 2-chloroethylvinyl ether
 chloroform
 dichlorobromomethane
 1,1-dichloroethane
 1,2-dichloroethane
 1,1-dichloroethylene
 1,2-dichloropropane
 1,3-dichloropropylene
 ethyl benzene
 methyl bromide
 methyl chloride
 methylene chloride
 1,1,2,2-tetrachloroethane
 tetrachloroethylene
 toluene
 1,2-trans-dichloroethylene
 1,1,1-trichloroethane
 1,1,2-trichloroethane
 trichloroethylene
 vinyl chloride

Acid Compounds

2-chlorophenol
 2,4-dichlorophenol
 2,4-dimethylphenol
 4,6-dinitro-o-cresol
 2,4-dinitrophenol
 2-nitrophenol
 4-nitrophenol
 p-chloro-m-cresol
 pentachlorophenol
 phenol
 2,4,6-trichlorophenol

Base/Neutral

acenaphthene
 acenaphthylene
 anthracene
 benzidine
 benzo(a)anthracene
 benzo(a)pyrene
 3,4-benzofluoranthracene
 benzo(ghi)perylene
 benzo(k)fluoranthene
 bis(2-chloroethoxy)methane
 bis(2-chloroethyl)ether
 bis(2-ethylhexyl)phthalate
 4-bromophenyl phenyl ether
 butylbenzyl phthalate
 2-chloronaphthalene
 4-chlorophenyl phenyl ether
 chrysene
 dibenzo(a,h)anthracene
 1,2-dichlorobenzene
 1,3-dichlorobenzene
 1,4-dichlorobenzidine
 3-3'-dichlorobenzidine
 diethyl phthalate
 dimethyl phthalate
 di-n-butyl phthalate
 2,4-dinitrotoluene
 2,6-dinitrotoluene
 di-n-octyl phthalate
 1,2-diphenylhydrazine
 fluoranthene
 fluorene
 hexachlorobenzene
 hexachlorobutadiene
 hexachlorocyclopentadiene
 hexachloroethane
 indeno(1,2,3-cd)pyrene
 isophorone
 naphthalene
 nitrobenzene
 N-nitrosodimethylamine
 N-nitrosodi-n-propylamine
 N-nitrosodiphenylamine
 phenanthrene
 pyrene
 1,2,4-trichlorobenzene

Pesticides

aldrin
alpha-BHC
beta-BHC
gamma-BHC
delta-BHC
chlordane
4,4'-DDT
4,4'-DDE
4,4'-DDD
dieldrin
alpha-endosulfan
beta-endosulfan
endosulfan sulfate
endrin
endrin aldehyde
heptachlor
heptachlor epoxide
PCB-1242
PCB-1254
PCB-1221
PCB-1232
PCB-1248
PCB-1260
PCB-1016
toxaphene

**Other Toxic Pollutants (Metals and Cyanide)
and Total Phenols**

antimony, total
arsenic, total
beryllium, total
cadmium, total
chromium, total
copper, total
lead, total
mercury, total
nickel, total
selenium, total
silver, total
thallium, total
zinc, total
cyanide, total
phenols, total

Appendix M: Glossary, Abbreviations/Acronyms, and Units

GLOSSARY

- Acid Base Neutrals (ABNs)** - Also called semi-volatile organics. A category of organic chemical pollutants. See Appendix L.
- Acute** - A stimulus severe enough to rapidly induce an effect; in aquatic toxicity tests, an effect observed in 96 hours or less typically is considered acute. When referring to aquatic toxicology or human health, an acute effect is not always measured in terms of lethality.
- Acute Criteria-** The maximum concentration of a constituent in water that an organism may be exposed to for a total of one hour, once over three years, without dying.
- Acute Static Toxicity Test** - Test designed to measure water quality effect on mortality. It measures the effect of the whole effluent sample on an organism. Animals are put in a vial with effluent, and the fatal effects are monitored. To calculate water quality standards, the test is run on sensitive animals. The concentration that shows a 95% mortality rate is then multiplied by two.
- Activation** - An event when the wastewater flow exceeds the holding capacity of the sewer lines and exceeds the hydraulic capacity of the treatment plant causing a diversion of flow to the CSO facilities.
- Aeration** - The process of adding air to a liquid (e.g. wastewater).
- Aliquot** - A measured portion of a sample.
- Anaerobic Digester** - The structure where organic material is broken down by organisms in the absence of oxygen.
- Anoxia** - The absence of oxygen.
- Average Monthly Discharge Limitation** - The highest allowable average of “daily discharge” over a calendar month, calculated as the sum of all daily discharges measured during a calendar month divided by the number of daily discharges measured.
- Average Weekly Discharge Limitation** - The highest allowable average of “daily discharge” over a calendar week, calculated as the sum of all daily discharges measured during a calendar week divided by the number of daily discharges measured during that week.
- Bar Screen** - A screen made of bars designed to catch large debris (e.g. rags, wood, shoes) in waterways.
- Below Detection Limit/Level (BDL)** - Values below the Reporting or Quantitation Limit. For further explanation see Appendix K.
- Bioaccumulation** - The process by which a compound is taken up by an aquatic organism, both from water and through food.
- Biochemical** - Having to do with a chemical change resulting from the metabolic activities of living organisms.
- Biochemical Oxygen Demand (BOD)** - The amount of oxygen needed to oxidize inorganic materials and to degrade organic materials by *biochemical reactions* in a certain time at a certain temperature. BOD is used as a measure of organic pollution.
- Biomagnification** - The process by which the concentration of a compound increases in species occupying successive trophic levels.
- BDL** - See Below Detection Limit
- Bloom** - A large mass of algae (microscopic and or macroscopic) in water.
- BOD** - See Biochemical Oxygen Demand.
- Buffering Capacity** - Measures the ability of certain water bodies to resist changes in pH from addition of acidic or caustic substances.
- CFR-** See Code of Federal Regulations
- 40 CFR Part 122** - Code of Federal Regulations: Protection of the Environment. Part 122 is Administered Permit Programs: The National Pollutant Discharge Elimination System. (Appendix D of 40 CFR 122 lists the Permit Application Requirements.)

Chemical Oxygen Demand (COD) - The amount of oxygen needed for the *chemical oxidation* of chemicals in water. COD is used to measure the suitability of water for organisms that require oxygen.

Chlorination - The addition of chlorine or chlorine compounds to wastewater. Chlorination is most often done for disinfection purposes.

Choking - A process by which flows that can not be handled by existing pumps are “choked back” into the sewer system, frequently leading to local overflows.

Chronic - A stimulus that lingers or continues for a relatively long period of time, often one-tenth of the life span or more. Chronic should be considered a relative term depending on the life span of an organism. The measurement of a chronic effect can be reduced growth, reduced reproduction, etc., in addition to lethality.

Chronic Criteria - The maximum concentration of a constituent in water that an organism may be exposed to for a total of four days over three years without showing long term, harmful effects, short of mortality. Chronic criteria involve the growth, reproductivity, fertility, and sublethal effects on organisms.

Chronic Reproduction Test - A test designed to measure the chronic effects of wastewater on reproduction and fertility.

Chronic Survival and Growth Test - Test designed to see if any mortality occurs after the chronic criteria have been passed. After the organisms have survived, the size of the animals are measured after seven days and statistically compared to controls.

Clean Water Act (CWA) - Formally referred to as the Federal Water Pollution Control Act or Federal Water Pollution Control Act Amendments of 1972. Pub. L. 92-500, as amended by Pub. L. 95-576, Pub. L. 96-483, and Pub. L. 97-117: 33 U.S.C. §1251 *et seq.*

COD - See Chemical Oxygen Demand

Code of Federal Regulations (CFR) - Codification of the general and permanent rules of the federal government. CFR 40 covers environmental protection.

Combined Sewer - A sewer receiving both sanitary wastewater and stormwater runoff.

Combined Sewer Overflow Facility - A place where overflow from combined sewers is screened, settled, and chlorinated before being discharged.

Combined Sewer Overflow Pipe - A pipe that discharges overflow from combined sewers in order to prevent back-ups in the sewerage system.

Composite Sample - A sample consisting of a minimum of eight grab samples collected at equal intervals during a 24-hour period (or lesser period if specified) and combined proportional to flow, or a sample continuously collected proportionally to flow over that same time period.

Conventional Parameters/Pollutants - Those pollutants and constituents that are removed from wastewater by conventional treatment. Generally these constituents are settleable solids, biochemical oxygen demand, total suspended solids, oil and grease, total coliform, fecal coliform, residual chlorine, and chlorides.

Conventional Treatment - Well-known or well-established water or wastewater treatment methods, usually consisting of primary and secondary processes and may include advanced or tertiary treatment.

Criteria - The numerical and or narrative elements of water quality standards.

Critical Dilution - Dilution of the effluent required to meet Water Quality Standards.

CWA - See Clean Water Act.

Daily Discharge - The discharge of a pollutant measured during a calendar day or any 24-hours period that reasonably represents the calendar day for purposes of sampling. For pollutants with limitations expressed in units of mass, the daily discharge is calculated as the total mass of the pollutant discharged over the day. For pollutants with limitations expressed in other units of measurements, the daily discharge is calculated as the average measurement of the pollutant over the day.

Designated Use - Specified use of a body of water included in state water quality standards.

Digester - A place where organic matter is broken down either with oxygen (aerobically) or without oxygen (anaerobically).

Disinfection - The destruction of pathogens (e.g. fecal coliform bacteria) in a water source or wastewater.

Effluent - The wastewater or other water coming out of a treatment facility or process.

Effluent Limitation - Any restriction imposed by the Director (the person authorized to sign NPDES permits by EPA and/or the State) on quantities, discharge rates, and concentrations of “pollutants” which are “discharged” from “point sources” into “waters of the United States,” the waters of the “contiguous zone,” or the ocean.

Eutrophication - The natural process by which a body of water ages. Nutrients stimulate plant growth and lakes, estuaries, and bays evolve into bogs or marshes. Effluent high in nutrient loadings cause excessive plant growth that accelerates eutrophication.

Fecal Coliform - Bacteria found in the wastes of warm-blooded animals. Fecal coliform is used as an indicator that disease causing bacteria and viruses are present. It is a component of Total Coliform.

Floatables - Constituents of wastewater that rise to the surface in the settling process, consisting mainly of oil, grease, and plastics.

Grab Sample - An individual sample collected in a period of less than 15 minutes.

Gravity Facility - A combined sewer overflow facility that receives flows by gravity (descending gradients from source to outfall) and no pumping is required.

Grit - Heavy suspended mineral matter in wastewater like sand and gravel.

Grit Chamber - A detention tank where grit is separated by sedimentation (grit settles to the bottom). The settling is controlled by the velocity of the water.

Headworks - A structure where wastewater are screened out and grit and other solids are trapped before the wastewater is pumped to a treatment facility.

Human Health Criteria - Estimated concentrations or quantities of chemicals that can be expected to occur in the environment in water, sediment, or food and that are not likely to pose a significant risk to the exposed human population. Human health criteria are published under section 304(a) of the CWA and are based on the latest scientific information. This information is updated and issued to the states to serve as guidance for the development of criteria.

Hydrocarbons - Chemical compounds only containing hydrogen and carbon.

Hypochlorite - The chemical used for chlorine disinfection of wastewater (either calcium, sodium, or lithium hypochlorite).

Hypoxia - The state of very low oxygen concentration.

IDL - See Instrument Detection Limit.

I/I - Infiltration and Inflow.

Infiltration - Groundwater that enters sewer pipes through cracks.

Inflow - Water that enters sewer pipes through illegal connections and storm water runoff.

Inorganic - Not containing carbon.

Influent - Wastewater or other water going into treatment facility or process.

Instrument Detection Limit (IDL) - The smallest amount of a substance a particular instrument is capable of detecting. See Appendix K for further explanation.

Interceptor - A large sewerage line collecting water from smaller sewerage pipes.

J values - Values between the Method Detection Limit and the Quantitation (or Reporting) Limit. See Appendix K for further explanation.

Lethal Concentration 50% (LC50) - The concentration of effluent in a sample that causes mortality to 50% of the test population at a specific time of observation.

Limiting Nutrient - In a given ecosystem, the limiting nutritional factor that controls the growth of plants or animals. Usually the limiting nutrient for plant growth is nitrogen in the marine environment and phosphorus in the fresh water environment. The limiting nutrient can also be thought of as the specific nutrient that will have the most impact on a receiving body of water (for example, the acceleration eutrophication of fresh water bodies caused by phosphorus in wastewater effluent).

Local Limits - The development of specific limits as part of MWRA's General Pretreatment Program: "The permittee shall develop and enforce specific effluent limits for industrial users, and all other users, as appropriate, pursuant to 40 CFR 403.5."

Lowest Observed Effect Concentration (LOEC) - The lowest concentration of effluent to which organisms are exposed in a life cycle or partial life-cycle test which contains an adverse effect (on survival, growth, and reproduction).

Maximum Acceptable Toxicant Concentration (MATC) - The effluent concentration that may be present in a receiving water body without causing significant harm to productivity or other uses. The MATC is determined by the results of chronic tests of either a partial life-cycle with sensitive life stages or a full life-cycle of the test organism. The MATC is the geometric mean of the No Observed Effect Concentration and the Lowest

Observed Effect Concentration.

Maximum Daily Discharge Limitation - The highest allowable daily discharge.

MBAS - See Methylene Blue Anion Surfactant

MDL - See Method Detection Limit

Metals - A group of priority pollutants. See Appendix L for a complete list.

Method Detection Limit (MDL) - The smallest amount of a substance that can be detected above background noise by following a particular method of analysis. See Appendix K for further explanation.

Methylene Blue Anion Surfactant - See Surfactant.

Mixing Zone - Area where discharged effluent is first diluted. The area is extended to cover the secondary mixing in the ambient water body. A mixing zone is an allocated impact zone where water quality criteria can be exceeded as long as toxic conditions are prevented.

National Pollutant Discharge Elimination System (NPDES) - The national program for issuing, modifying, revoking and reissuing, terminating, monitoring, and enforcing permits, and imposing and enforcing pretreatment requirements, under sections 307, 402, and 405 of the Clean Water Act (CWA). The term includes an "approved program."

Nine Minimum Controls - Part of the EPA's CSO Policy. The Nine Minimum Controls are:

- 1) Proper operation and regular maintenance (O&M) programs for the sewer system and combined sewer overflow points
- 2) Maximum use of the collection system for storage
- 3) Review and modification of the pretreatment programs to assure CSO impacts are minimized
- 4) Maximization of flow to the POTW for treatment
- 5) Prohibition of CSO discharges during dry weather
- 6) Control of solid and floatable materials in CSO discharges
- 7) Pollution prevention programs that focus on contaminant reduction activities
- 8) Public notification to ensure that the public receives adequate notification of CSO occurrences and CSO impacts
- 9) Monitoring to effectively characterize CSO impacts and the efficacy of CSO controls.

Nitrification - The conversion of ammonia and nitrite to nitrate.

No Observed Acute Level (NOAL) - The highest concentration of effluent to which organisms are exposed in a short-term test in which at least 90% of the test organisms survive.

No Observed Effect Concentration (NOEC) - The highest concentration of effluent to which organisms are exposed in a life cycle or partial life cycle test which contains no adverse effects (on growth, survival, and reproduction).

NPDES - See National Pollutant Discharge Elimination System

Nutrient - Any element or compound essential as raw material for organism growth and development. Examples: phosphorus and nitrogen.

Oil and Grease - Fats, oils, and grease from animal and plant derivation. Also called FOGs.

Organic Compounds - Volatiles, Acid Compounds, Base/Neutral, and Pesticides. Organics are listed in 40 CFR Ch. 1 Appendix D under CWA Section 307(a). See Appendix L for a complete list.

Orthophosphorus - A form of phosphorus, included in nutrients.

Outfall - the site of initial discharge

PAH - See Polynuclear Aromatic Hydrocarbon

Pesticides/PCBs - Subdivision of priority pollutants. See Appendix L for a complete list.

Petroleum Hydrocarbon (PHC) - Oil and grease from petroleum derivation.

pH - The negative log of the hydrogen ion concentration used to express acidity (<7) and alkalinity (>7).

PHC - See Petroleum Hydrocarbon.

Pollutant - Dredged spoil, solid waste, incinerator residue, filter backwash, sewage, garbage, sewage sludge, munitions, chemicals wastes, biological materials, radioactive materials, (except those regulated under the Atomic Energy Act of 1954, as amended (42 U.S.C. §2011 *et seq.*)), heat, wrecked or discarded equipment, rock, sand, cellar dirt and industrial, municipal, and agricultural waste discharged into water.

It does not mean: (a) Sewage from vessels; or (b) Water, gas, or other material which is injected into a well to facilitate production of oil or gas, or water derived in association with oil and gas production and disposed or in

a well, if the well used either to facilitate production or for disposal purposes is approved by authority of the State in which the well is located, and if the State in which the well is located, and if the State determines that the injection or disposal will not result in the degradation of ground or surface water resources.

Polynuclear Aromatic Hydrocarbon (PAH) - A type of semi-volatile organic. Also known as polycyclic aromatic hydrocarbon.

POTW - See Publicly Owned Treatment Work

Preaeration - The process by which air is added to primary influent to help in the removal of gases, floatation of grease, addition of oxygen, and in the settling or coagulation of wastewater.

Prechlorination - The addition of chlorine to primary influent at or near the beginning of the treatment facility/process.

Primary Settling - The detention of wastewater as part of primary treatment to settle out solids (sludge) and collect floatables (scum).

Primary Treatment - Screening and settling of wastewater.

Priority Pollutants - Refers to some of the chemicals listed in 40 CFR Ch. 1 Appendix D under Section 307(a) of the CWA. There are 65 compounds and families of compounds that are among the most persistent, prevalent, and toxic of chemicals known to man. These 65 compounds or families of compounds have been translated into 126 individual pollutants. See Appendix L, Table L-2 for the complete list.

Priority Pollutant Scan - A series of chemical analyses to identify the presence of priority pollutants.

Publicly Owned Treatment Work (POTW) - Any facility or system used in the treatment (including recycling and reclamation) of municipal sewage or industrial wastes of liquid nature that is owned by a "State" or a "municipality." This definition includes sewers, pipes, or other conveyances only if they convey wastewater to a POTW providing treatment.

Pumping Station - Structures where wastewater from low lying areas is pumped.

Quantitation Limit - See Reporting Limit.

Removal Rate - or Percent Removal. Defined as the influent concentration minus the effluent concentration, divided by the influent concentration.

Reporting Limit - The smallest concentration that can be quantified. On a graph of pollutant concentration versus instrument response, the reporting limit is the smallest concentration where the linear relationship holds before starting to curve as the pollutant concentration goes to zero. Also called the Quantitation Limit. See Appendix K for further explanation.

Residuals - Matter left over by treatment processes including screenings, scum, and sludge.

Screening - The process by which sewage from interceptors first goes through headworks where grit and large objects like leaves, sticks, and hygiene products (like tampon applicators and condoms) are screened out.

Screenings - The objects that are collected by the process of screening.

Scum - Solids that float to the top of wastewater.

Secondary Treatment - The treatment of wastewater beyond solids and grit removal. The process decreases the organic load.

Sedimentation - The process by which solids are allowed to settle by gravity.

Sedimentation Tank - Tanks used to detain wastewater while the solids settle out.

Semi-Volatile Organics - Also known as Acid Base Neutrals (ABNs). A subcategory of organic pollutants. See Appendix L for a complete list.

Separate Sewer - A sewerage system divided into a storm sewer and a sanitary sewer.

Settleable Solids - The estimated amount of sludge that will settle by sedimentation. It is a fraction of the suspended-solids.

Settled Solids - Sludge. (See sludge.)

Sewage - Any wastes, including wastes from humans, households, commercial establishments, industries, and stormwater runoff, that are discharged to or otherwise enter a POTW.

Sludge - Solids, residues, and precipitate separated from or created in sewage by the unit processes of a POTW.

SOP - See System Optimization Plan or Standard Operating Procedures

Stratification - The separation of water into layers characterized by thermal differences.

Standard Operating Procedures (SOP) - Documented protocols for plant operation, laboratory procedures, etc.

Surcharging - When the capacity of the sewer is insufficient and sewage escapes through a manhole.

Surfactant - Surface-active agent. Large organic molecules that cause foaming. They are usually found in detergents.

System Optimization Plan (SOP) - Hydraulic improvements that, in conjunction with ongoing programs of municipal sewerage agencies, might promote a balanced hydraulic system, including optimization of the collector/interceptor system upstream of regulators, to ensure that the storage and transport capacity of the system is maximized within constraints unalterable except for major structural modifications.

Thickener - The structure where sludge is sent to be thickened by removing water.

TKN - See Total Kjeldahl Nitrogen.

Total Coliform - Bacteria found in decaying matter, feces, and soil. It used as an indicator of pathogens that are present in wastewater. (Fecal Coliform is a component of Total Coliform.)

Total Kjeldahl Nitrogen (TKN) - The total organic and ammonia nitrogen.

Total Phosphorus - A measure of all the forms of phosphorus, a nutrient, found in water (orthophosphates, polyphosphates, and organic phosphates).

Total Suspended Solids (TSS) - The sum of insoluble solids that either float on the surface of, or are in suspension in water, wastewater, or other liquids.

Toxic Pollutant - Any pollutant listed as toxic in Appendix D of 40 CFR Part 122, under Section 307(a)(1) of CWA.

Toxics - Pollutants that have a toxic effect on living organisms. The “priority pollutants” of CWA Section 307(a) are a subset of this group of pollutants.

Toxicity Test - A procedure to determine the toxicity of a chemical or an effluent using living organisms. A toxicity test measures the degree of effect on exposed test organisms of a specific chemical or effluent.

TSS - See Total Suspended Solids.

Twelve Month Running Average - The monthly average computed using the specific month and the previous 11 months.

Unregulated Community - Dischargers not required to have Permits to discharge into MWRA sewerage system. They are not regulated or required to meet Local Limits, nor are they regulated under the Local Limits Discharge Program.

Vertical Mixing - The vertical movement of the water column caused by wind, and/or density and/or temperature differences.

Volatile Organic Acid (VOA) - Same as Volatile Organic Compound.

Volatile Organic Compound (VOC) - Same as Volatile Organic Acid.

Volatile Solids - Those solids of a suspended solid sample that are burned off in a muffle oven at 550 ± 50 °C.

Water Quality - The chemical, biological, and physical conditions of a body of water.

Water Quality Criteria - Specific levels of pollutants that would make a body of water unsuitable for its designated use (i.e. harmful if used for drinking, swimming, farming, fishing, or industrial processes).

Water Quality Standard - A law or regulation that consists of: the beneficial designated use or uses of a water body; the numeric and narrative water quality criteria that are necessary to protect the use or uses of that particular water body; and an antidegradation statement.

Whole Effluent Toxicity (WET) - The total toxic effect of effluent, not chemical specific but rather the cumulative effect, whether it be synergic or antagonistic, of the chemicals found in the effluent.

ABBREVIATIONS, ACRONYMS AND UNITS

Abbreviations, Acronyms

ABNs - Acids Bases Neutrals
BDL - Below Detection Limit
BOD - Biochemical Oxygen Demand
BWSC - Boston Water and Sewer Commission
CFR - Code of Federal Regulations
CSO - Combined Sewer Overflow
CWA - Clean Water Act
DEP - Massachusetts Department of Environmental Protection
DITP - Deer Island Treatment Plant
ENQUAD - Environmental Quality Department
EPA - United States Environmental Protection Agency
FY - Fiscal Year
IDL - Instrument Detection Level
I/I - Infiltration and Inflow
LC50 - Median Lethal Concentration
LD50 - Median Lethal Dose
LOAEL - Lowest Observed Adverse Effect Level
LOEC - Lowest Observed Effect Concentration
MATC - Maximum Acceptable Toxicant Concentration
MDC - Metropolitan District Commission
MDL - Method Detection Limit
MPN - Most Probable Number
MWRA - Massachusetts Water Resources Authority
NITP - Nut Island Treatment Plant
NOAL - No Observed Acute Level
NOEC - No Observed Effect Concentration
NPDES - National Pollutant Discharge Elimination System
PAH - Polycyclic (or Polynuclear) Aromatic Hydrocarbon
PCB - Polychlorinated Biphenyl
PHC - Petroleum Hydrocarbon
POTW - Publicly Owned Treatment Work
SD - Standard Deviation
SOP - Standard Operating Procedures or System Optimization Plan
SSO - Sanitary Sewer Overflow
TKN - Total Kjeldahl Nitrogen
TRAC - Toxic Reduction and Control Department
TSS - Total Suspended Solids
VOA - Volatile Organic Acid
VOC - Volatile Organic Compound
WET - Whole Effluent Toxicity [test]

Units

in/yr - inches per year	mgd - million gallons per day
L - liter	mg/L - milligrams per liter
lbs - pounds	µg/L (or ug/L) - micrograms per liter
lbs/day - pounds per day	
mL/L - milliliters per liter	
MG - million gallons	



Massachusetts Water Resources Authority
Charlestown Navy Yard
100 First Avenue
Boston, MA 02129
(617) 242-6000